

PowerLogic™ ION8650

Energy and power quality meter

User guide

70002-0306-00

05/2011

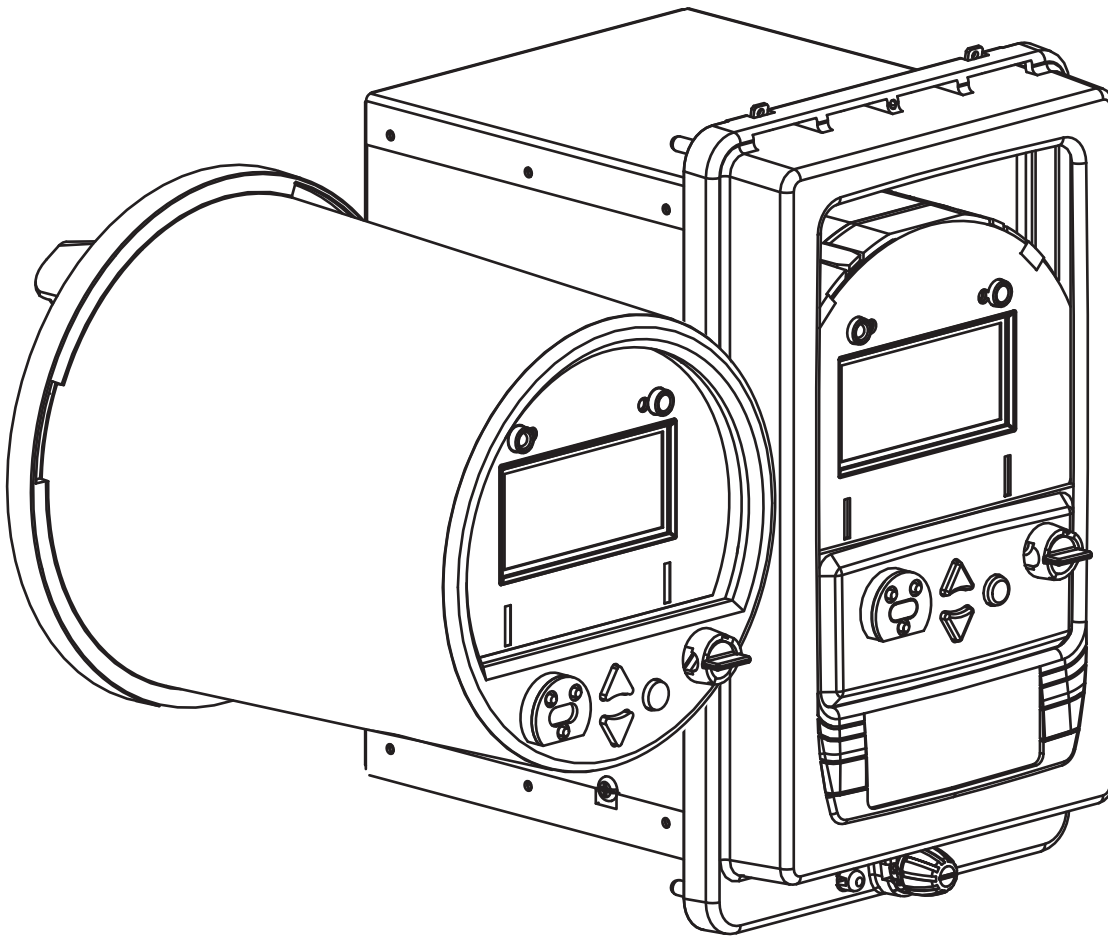

Hazard categories and special symbols

Read these instructions carefully and look at the equipment to become familiar with the device before trying to install, operate, service or maintain it. The following special messages may appear throughout this manual or on the equipment to warn of potential hazards or to call attention to information that clarifies or simplifies a procedure.



The addition of either symbol to a “Danger” or “Warning” safety label indicates that an electrical hazard exists which will result in personal injury if the instructions are not followed.

This is the safety alert symbol. It is used to alert you to potential personal injury hazards. Obey all safety messages that follow this symbol to avoid possible injury or death.

DANGER

DANGER indicates an imminently hazardous situation which, if not avoided, **will result in death or serious injury**.

WARNING

WARNING indicates a potentially hazardous situation which, if not avoided, **can result in death or serious injury**.

CAUTION

CAUTION indicates a potentially hazardous situation which, if not avoided, **can result in minor or moderate injury**.

CAUTION

CAUTION used without the safety alert symbol indicates a potentially hazardous situation which, if not avoided, **can result in equipment damage**.



NOTE

Provides additional information to clarify or simplify a procedure.

Please note

Electrical equipment should be installed, operated, serviced and maintained only by qualified personnel. No responsibility is assumed by Schneider Electric for any consequences arising out of the use of this material.

Notices

FCC notice

This equipment has been tested and found to comply with the limits for a Class B digital device, pursuant to part 15 of the FCC Rules. These limits are designed to provide reasonable protection against harmful interference in a residential installation. This equipment generates, uses, and can radiate radio frequency energy and, if not installed and used in accordance with the instructions, may cause harmful interference to radio communications. However, there is no guarantee that interference will not occur in a particular installation. If this equipment does cause harmful interference to radio or television reception, which can be determined by turning the equipment off and on, the user is encouraged to try to correct the interference by one or more of the following measures.

- ◆ Reorient or relocate the receiving antenna.
- ◆ Increase the separation between the equipment and receiver.
- ◆ Connect the equipment to an outlet on a circuit different from that to which the receiver is connected.
- ◆ Consult the dealer or an experienced radio/TV technician for help.

This Class B digital apparatus complies with Canadian ICES-003.

Network compatibility notice for the internal modem

The internal modem in meters equipped with this option is compatible with the telephone systems of most countries in the world, with the exception of Australia and New Zealand. Use in some countries may require modification of the internal modem's initialization strings. If problems using the modem on your phone system occur, please contact Schneider Electric Technical Support.

Table of Contents

Chapter 1	Safety precautions	7
Chapter 2	Introduction	9
Chapter 3	Front panel	19
Chapter 4	Templates and firmware	39
Chapter 5	Basic setup	49
Chapter 6	Security	53
Chapter 7	Communications	73
Chapter 8	Third party protocols	97
Chapter 9	Time	117
Chapter 10	Demand	123
Chapter 11	Inputs / Outputs	131
Chapter 12	Energy pulsing	141
Chapter 13	Logging	147
Chapter 14	Revenue	159
Chapter 15	Power quality	169
Chapter 16	Displays	175
Chapter 17	TEST mode	187
Chapter 18	Resets	197
Chapter 19	Setpoints	203
Chapter 20	Reports	207

Chapter 1

Safety precautions

Installation, wiring, testing and service must be performed in accordance with all local and national electrical codes.

DANGER

HAZARD OF ELECTRIC SHOCK, EXPLOSION OR ARC FLASH

- Apply appropriate personal protective equipment (PPE) and follow safe electrical work practices. See NFPA 70E in the USA or applicable local standards.
- This equipment must only be installed and serviced by qualified electrical personnel.
- Turn off all power supplying this device and the equipment in which it is installed before working on the device or equipment.
- Always use a properly rated voltage sensing device to confirm that all power is off.
- Do not perform Dielectric (Hi-Pot) or Megger testing on this device.
- Connect protective ground (earth) before turning on any power supplying this device.
- Replace all devices, doors and covers before turning on power to this equipment.

Failure to follow these instructions will result in death or serious injury.



NOTE

Do not perform Dielectric (Hi-Pot) or Megger testing on the ION8650 because its internal surge protection circuitry starts functioning at levels below typical Hi-Pot voltages. Contact your local Schneider Electric representative for more information on device specifications and factory testing.

Chapter 2 Introduction

PowerLogic™ ION8650 meters provide revenue-accurate, true RMS measurements of voltage, current, power and energy, and are complemented by extensive I/O capabilities, comprehensive logging, and advanced power quality measurement and compliance verification functions. The meters come with an extensive selection of pre-configured data screens and measurements, so you can use the meters with their default configuration after you perform basic setup. You can also customize the meter to fit your unique requirements.

ION8650 meters give you the tools to manage complex energy supply contracts that include commitments to power quality. You can also integrate the meters with ION Enterprise™ or other energy management, SCADA, automation and billing systems, via Internet communications and multiple industry-standard communication channels and protocols including MV-90 and IEC 61850.

In this chapter

- ◆ **ION8650 meters** 10
- ◆ **ION8650 in enterprise energy management systems** 11
 - The meter is factory-configured and ready to operate 11
 - Measured Parameters 12
 - Energy 12
 - Demand 12
 - Instantaneous 12
 - Harmonics 13
 - Min/Max recording 13
 - Power quality 13
 - Data display and analysis tools 14
 - The front panel 14
 - WebMeter internal web server feature 14
 - Meter internal email server feature 14
 - XML compatibility 14
 - ION Enterprise software 14
 - ION Setup software 15
 - MV-90 15
 - IEC 61850 15
 - Alerting 15
 - Communications methods 16
 - Digital and analog I/O options 16
 - Onboard I/O 16
 - Expanded I/O 16
- ◆ **Additional information** 17

ION8650 meters

The meter is suited to a wide range of applications. The meters can be used as stand-alone devices, but their extensive capabilities are fully realized when used as part of an enterprise energy management (EEM) system. The ION8650 is available with the following feature sets:

Model	Feature set
ION8650A	128MB memory, 50 data recorders (800 channels), 4-30 Class A + EN50160 power quality analysis (waveforms and transient detection)
ION8650B	64MB memory, 45 data recorders (320 channels), 4-30 Class S + EN50160 power quality monitoring
ION8650C	32MB memory, 4 data recorders (64 channels)



NOTE

For complete details of the ION8650 meter feature sets, see the ION8650 Datasheet available from www.schneider-electric.com.

ION8650 naming convention

In the serial number and ANSI bar code area of the meter's front panel you can view the feature set, form factor and any special order options available with the meter. For example:

S8650A0C0H6E0B0A			
S8650	Brand and model	H6	Power supply and system frequency
A0	Feature set and form factor	E0	Communications
C0	Voltage/current inputs	B0A	I/O, security and special options

When there are differences between the models (such as a feature specific to one model), it is indicated with the appropriate model number in this document.

ION8650 in enterprise energy management systems

Applications that include the meter typically require additional equipment. Display and analysis software tools are almost always used to manage, interpret and distribute the data measured or logged by a meter. There are usually a variety of tools used, and often these tools are connected using different communications standards and protocols.

The meter can adapt to many situations. Advanced communications allow data to be shared simultaneously across multiple networks, built-in I/O provides monitoring and non-critical control capabilities, and a variety of display and analysis tools can be used to monitor your power system.

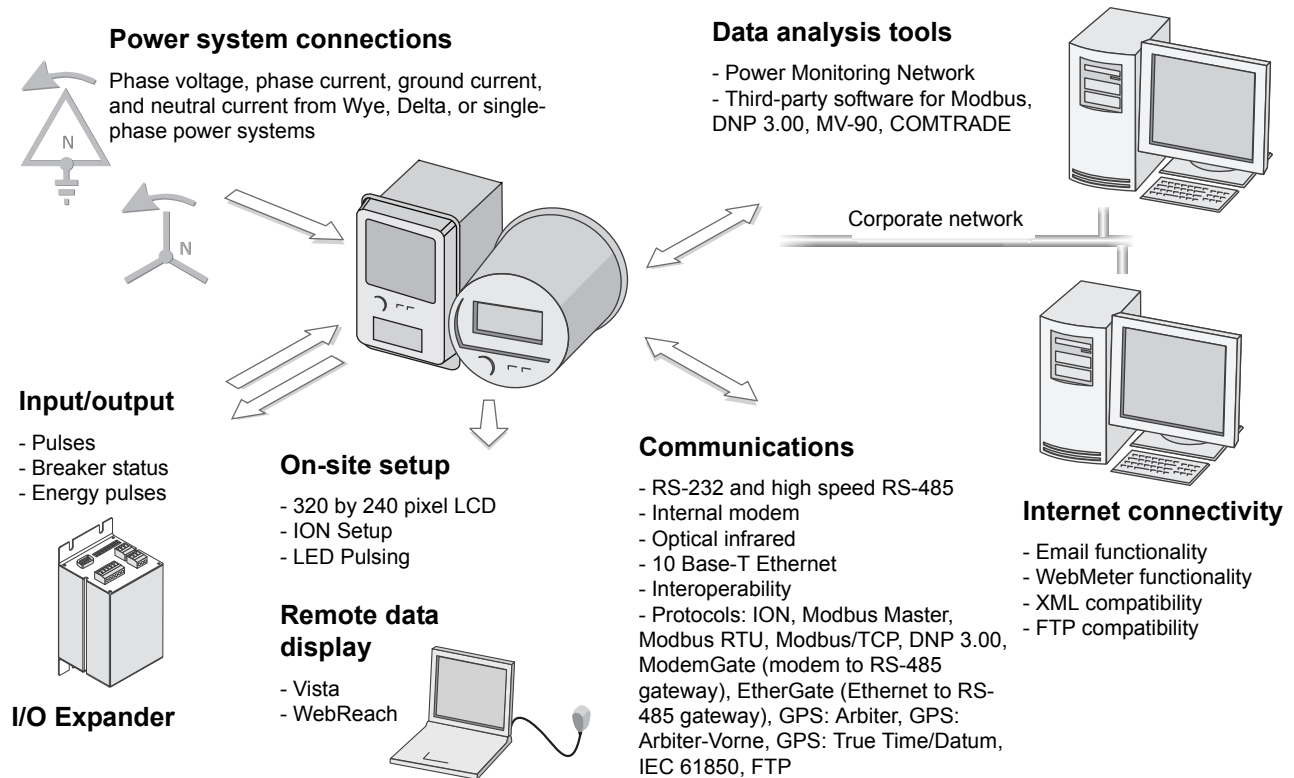

The meter is factory-configured and ready to operate

Your meter is preconfigured to provide most of the functionality needed in many applications. After you perform the installation and basic setup, all of the basic measurements, energy calculations and recording functions are ready to operate. The meter can also be fully customized if necessary to meet your needs.

Measured Parameters

The meter provides fully bi-directional, 4-quadrant, revenue accurate energy metering. The following sections list some of the parameters measured by the meter.

Energy

The meter provides all common active, reactive and apparent energy parameters.

- ◆ kWh, kVARh, kVAh delivered and received
- ◆ kWh, kVARh, kVAh net (delivered - received)
- ◆ kWh, kVARh, kVAh total (delivered + received)
- ◆ Volt-hours and amp-hours
- ◆ Integration of any instantaneous measurement

Energy registers can be logged automatically on a programmed schedule. All energy parameters represent the total for all three phases.

Demand

The meter supports standard demand calculation methods, including block, sliding window (rolling block), and predicted demand. It can measure demand on any instantaneous value and record peak (maximum) and minimum demand with date and timestamps to the second. Peak demand registers can be reset manually (password protected) or logged and reset automatically on a programmed schedule.

Measurements include:

- ◆ kW, kVAR, kVA demand, min/max
- ◆ Amps, Volts demand, min/max
- ◆ Demand on any instantaneous measurement

Instantaneous

The meter provides highly accurate, 1 second or 1/2 cycle measurements, including true RMS, per phase and total for:

- ◆ Voltage and current
- ◆ Active power (kW) and reactive power (kVAR)
- ◆ Apparent power (kVA)
- ◆ Power factor and frequency
- ◆ Voltage and current unbalance
- ◆ Phase reversal

Harmonics

Complete harmonic distortion metering, recording and real-time reporting, up to the 63rd harmonic for all voltage and current inputs.

- ◆ Individual harmonics (including magnitude, phase and inter-harmonics)
- ◆ Total even harmonics and total odd harmonics
- ◆ Total harmonics (even + odd)
- ◆ K-factor, Crest factor

Min/Max recording

The meter records each new minimum and new maximum value with date and time-stamp for the following parameters:

- ◆ Voltage and current min/max
- ◆ kW, kVAR, and kVA min/max
- ◆ Power factor
- ◆ Frequency
- ◆ Voltage unbalance
- ◆ Plus any measured value

Power quality

The meter measures and records the following parameters:

- ◆ Sag/Swells
- ◆ Transients (ION8650A only)

The meter also has the following power quality features:

- ◆ **EN50160:** ION8650A and ION8650B meters have a default framework that measures and presents EN50160 compliance according to guidelines defined by Eurelectric (UNIPED).
- ◆ **IEC 61000-4-30:** The meter complies with the IEC 61000-4-30 power quality standard as follows:
 - ◆ The ION8650A complies with IEC 61000-4-30 Class A.
 - ◆ The ION8650B complies with IEC 61000-4-30 Class S.
- ◆ **COMTRADE:** ION8650A meters can save waveform data in COMMon Format for TRAnsient Data Exchange (COMTRADE) format, which is then available for download via FTP. This is intended for use in conjunction with IEC 61850 and is only available on ION8650A meters with an Ethernet port.

Data display and analysis tools

The meter integrates seamlessly with display and analysis software available from Schneider Electric™. ION Enterprise software lets you analyze and monitor your system and produce reports for any department in an organization. ION Enterprise is designed to make use of all the available advanced capabilities. You can use also data acquired by the meter in a variety of third-party systems.

The front panel

Local monitoring and standalone applications are facilitated by the meter's front panel interface. The front panel combines real-time display features with basic device configuration functions. The front panel is often used in combination with ION Enterprise or ION Setup, providing an interface for field personnel.

WebMeter internal web server feature

WebMeter™ provides quick and easy access to real-time energy and basic power quality information without special software using an on-board web server combined with an Ethernet port. The built-in web pages display a range of energy and basic power quality information through the web-enabled device; these pages also support basic meter configuration tasks.

Meter internal email server feature

You can configure the meter to automatically email high-priority alarm notifications or scheduled system-status update messages to anyone, anywhere within the facility or around the world. Specify the type of event that triggers an email alert, such as power quality disturbances or logged data at any pre-determined interval, and have your ION Enterprise or ION Setup administrator program the meter to respond with an email message when these events occur. Email messages from your meter can be received like any email message over a workstation, cell phone, pager, or PDA.

XML compatibility

The meters can exchange information using industry-standard XML format. This simple, machine-readable format supports easy integration with custom reporting, spreadsheet, database, and other applications.

ION Enterprise software

ION Enterprise allows the meter to be part of a fully networked information system with other meters and local and wide-area computer networks. ION Enterprise is recommended for all power monitoring systems where advanced analysis and non-critical control capabilities are required.

ION Enterprise provides tools for managing your power monitoring network, logging data, analyzing real-time and logged data, generating power system reports, and creating custom functionality at the meter level.

ION Enterprise also offers ways to remotely view information through a web browser: for example, through the WebReach and Web Reporter components of ION Enterprise, and through Microsoft Terminal Services.

See the ION Enterprise Help for more information.

ION Setup software

ION Setup is a meter configuration tool designed specifically to configure and test meters. ION Setup offers a graphical interface for performing basic meter setup, installing templates into meters, upgrading firmware, viewing real-time and reset accumulated values, verifying meter accuracy and measurements, and setting up advanced security.

MV-90

MV-90 software (by Utility Translation Systems) is a multi-vendor translation system that can collect and analyze data from a variety of different brands of meters, each with unique database formats. MV-90 manipulates this data without extensive knowledge of the device of origin.

For more information on using the meter in an MV-90 system, see the *MV-90 and ION Technology* technical note.

IEC 61850

IEC 61850 is an Ethernet-based protocol designed for electrical substations. It is a standard (vendor-independent) method of communications, developed to support integrated systems composed of multi-vendor, self-describing devices. When properly configured, the ION8650 acts as a server in an IEC 61850 system.

Alerting

The meter can be configured to send alerts in response to power system conditions that you define, such as a power quality problem (including surges, sags and swells), changes in relays, or required equipment maintenance. This allows you to automatically advise key people of problems to allow quick remedial action, notify software so logs can be uploaded from the site that initiated the alert, or service equipment on schedule.

You can configure the meter to send alerts to email, pagers, or to software such as ION Enterprise.

For more information on configuring alerting on the meter, see the *ION meter alerts* technical note and the Alert module description in the *ION Reference*. For more information on configuring alerting in ION Enterprise, see the online *ION Enterprise help*.

Communications methods

The meter can be integrated into various industry-standard networks. Data from the meter can be made available to other devices using the Modbus™ Master, Modbus RTU, Modbus TCP, and DNP 3.00 protocols, as well the MV-90 translation system. You can also configure the meter to import data from devices on these networks. With these advanced communications functions, the meter operates in most existing power monitoring systems. Any data display and analysis software that works with these protocols also functions with the meter.

The standard meter includes a selectable RS-232/RS-485 port, a high-speed RS-485 port, and an optical port for communications in the field. Order options include a 10Base-T Ethernet port and 57.6 kbps internal modem (both FCC and CTR-21 compliant). Depending on the hardware options purchased, up to four separate ports can communicate simultaneously.

Digital and analog I/O options

Onboard I/O

There are two optional onboard I/O configurations available, each providing different capabilities. The number and form of the digital inputs and outputs depend on the option you ordered; see your meter's *Installation Guide* to determine the configuration available on your meter.

Additionally, two infrared ports (and corresponding LEDs) on the front panel are configured by default for energy pulsing.

Digital inputs

The meter can be ordered with internally or externally-excited Form A digital inputs. They can be used for tariff inputs and other pulse counting applications.

Digital outputs

The meter can be ordered with both Form C and Form A solid-state outputs.

Expanded I/O

The I/O Expander option extends the meter's I/O capabilities. The digital I/O Expander model provides four Form A digital outputs, four Form C digital outputs, and eight Form A digital inputs. The analog I/O Expander model replaces the four form A digital outputs with analog outputs.

Refer to the *PowerLogic I/O Expander Installation Guide* for details on the options and installation and operation instructions.

Additional information

For more information on the meter, including documentation downloads and software tools, visit www.schneider-electric.com. Available documentation includes:

Installation guide

This document is shipped with each meter. It details the mounting, wiring and basic setup of the device. There is a separate installation guide for the socket and the switchboard versions of the meter.

I/O Expander Installation guide

This document describes the optional external I/O device that you can connect to the meter, for additional digital I/O and analog output ports.

Online ION Setup help

The online ION Setup help has in-depth information on installation, setup and security of ION Setup. It also contains instructions on using the Setup Assistant to configure devices.

ION Reference

This document describes ION architecture and provides detailed descriptions of all modules in all ION meters.

Online ION Enterprise help

The ION Enterprise online help system provides information and instructions on using ION Enterprise components.

Technical notes

Technical notes are available from the website, and provide instructions for using meter features and for creating custom configurations.

Protocol documents

Each protocol document contains information explaining how the product interacts with a protocol, such as DNP 3.0, Modicon Modbus, IEC 61850 and MV-90.

ION device template reference

This document lists the default ION modules and their default configuration in the shipping template for the most recent firmware releases of ION meters.

Chapter 3 Front panel

The front panel provides a user-friendly interface from which you can view system data or configure basic meter settings. A scrollable display and three distinct modes (NORM, ALT and TEST) provide easy access to a range of functions through a simple three-button keypad.

This chapter describes the front panel and explains how to use it to display data, perform tests, and set up basic configuration options.

In this chapter

◆ Front panel features	20
LED pulsers	20
Demand reset switch	20
Navigation buttons	21
Optical port	21
Master reset button	21
TEST mode button	21
◆ Display screen types	22
The status bar	22
Numeric displays	22
Nameplate display and event log	23
Histogram displays	24
Phasor diagram displays	24
Disk simulator	24
Time and date	24
Time-stamped values	25
◆ Modes of operation	26
Basic operation (NORM mode)	26
ALT mode	26
TEST mode	27
◆ Configuring the meter with the front panel	28
Accessing the SETUP menu	28
Navigating the front panel screens	30
Configuring parameters using the navigation buttons	30
Confirming configuration changes	30
Setup menus	31
BASIC SETUP menu	31
COM port setup menus	32
ENABLED COM PORTS menu (ION8650C only)	35
FORMAT SETUP menu	36
DISPLAY SETUP menu	36
SECURITY menu	37

Front panel features

The front panel includes a liquid crystal display (LCD) with detailed graphics and text, up and down arrow buttons for screen navigation and basic setup procedures, as well as LED pulsers for testing the meter. This section outlines the features available on the front panel of the meter.

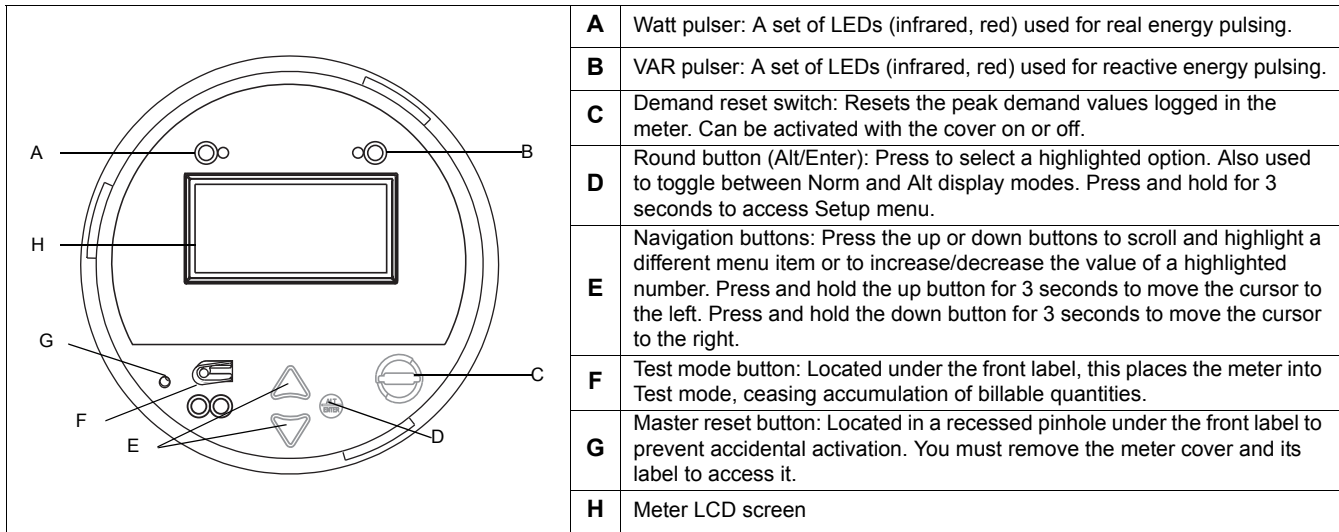

LED pulsers

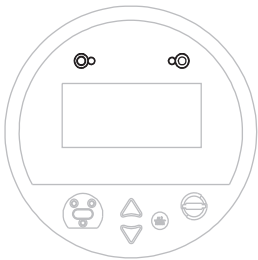

Two LED pulsers located near the top of the front panel represent WATT (to the left) and VAR (to the right).

These LEDs are pre-configured for energy pulsing. The adjacent infrared outputs are connected to the LEDs and pulse at the same rate. Pulse rates can be adjusted by editing the settings of the Calibration Pulser module; for a detailed description of LED pulser operation, see “Energy pulsing with LEDs” on page 143).

Demand reset switch

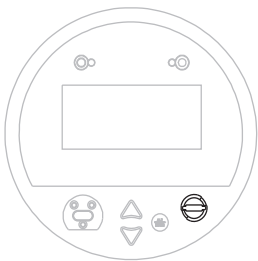

Located on the front of the meter's external cover assembly, the demand reset switch resets the peak demand values logged in the meter. This switch can be activated with the cover on or off. When the meter is in TEST mode, the demand reset switch resets the test demand parameters.

In most applications, the demand reset switch is sealed with an anti-tamper mechanism; a through-hole in the switch can accommodate either an external seal or a locking mechanism. See “Anti-tamper sealing methods” on page 69 for more information on anti-tamper sealing.

A Demand Lockout Time register sets the minimum time allowed between consecutive demand resets; the meter ignores any attempts to reset the demand outside the bounds of the register. The default value for the Demand Lockout Time is 25 days (2160000s). For details on the Demand Lockout Time setup register, see “Configuring demand reset lockout time” on page 126.

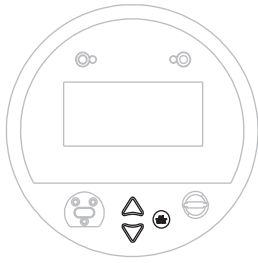

Navigation buttons

The navigation buttons are the up and down arrow buttons and the round **ALT/ENTER** button. Press the up or down arrow buttons to manually scroll back or forth through the available displays and temporarily halt the display screen's automatic scrolling function. Press **ALT/ENTER** to toggle between NORM and ALT display modes. The automatic scrolling function restarts 60 seconds after a button was last pressed.

Hold the **ALT/ENTER** button for approximately three seconds to display the setup menu. You can then use the navigation buttons to view the device's configuration or edit basic settings. See "Setup menus" on page 31 for further instruction on modifying the device's configuration using the front panel buttons.

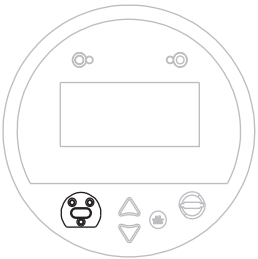

Optical port

An optical port facilitates infrared communication with the device. For details on how to configure and use this port, see "Configuring the optical port" on page 84.

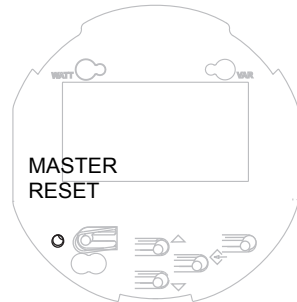

Master reset button

You must remove the meter's cover as well as the front panel label to access the master reset button; it is located in the lower left of the faceplate. This button is recessed to prevent accidental activation. For instructions on removing the meter cover and performing a master reset, and information on what parameters are reset, see "Performing a master reset from the front panel" on page 199.

Use the master reset button to delete most accumulated values and all derived revenue measurements from the meter.

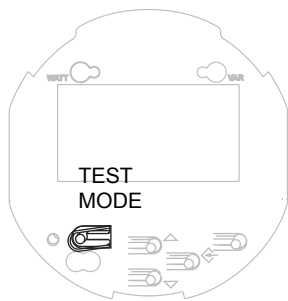

TEST mode button

The TEST mode button is located under the meter's external cover assembly; it places the meter into TEST mode. While in TEST mode, the meter stops accumulating billable quantities; energy and demand measurements are accumulated in TEST mode registers.

See "TEST mode" on page 27 for more details on this mode of operation.

Display screen types

The front panel displays measurements, event logs, phasor diagrams, bar graphs, harmonics histograms, configured settings and configuration data. The types of display screens are described below.

As shown in the graphics in the following sections, the display screen is divided into two sections: the main display area and the status bar. The main display area presents meter data and status information; the status bar provides time, date, phase, quadrant, and mode information. During normal operation, the main display area automatically cycles through a series of several displays. If you prefer, you can use the up or down arrow buttons to step manually through these displays. By default, the automatic scrolling resumes 60 seconds after you have pressed a button.

TIP

To adjust the contrast, hold down the up and down arrow buttons simultaneously. When the contrast reaches the desired level, release the buttons.

For information on customizing the display on your meter, see “Configuring front panel displays” on page 177.

The status bar

The status bar runs along the bottom of the front panel display and contains information about the following settings:

- ◆ Date and time (in 24 hour format).
- ◆ Voltage phases present. The labels and rotation of phases correspond to the configuration of the power monitoring system.
- ◆ Quadrant where the system power factor resides.
- ◆ Mode (NORM, ALT or TEST).
- ◆ Time remaining in the sliding window (or rolling block) demand interval. If the interval has counted to zero the letters **EOI** (End Of Interval) appear on the status bar.

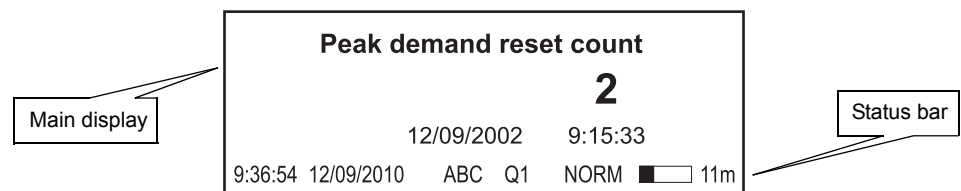

Numeric displays

All NORM mode data and some of the ALT mode display screens use numeric displays. Numeric displays show up to four parameters at a time. If no numeric values are available for a parameter, N/A is displayed.

```

Peak demand reset count
          2
    12/09/2002  9:15:33
9:36:54 12/09/2010  ABC Q1  NORM  11m

```

By default, the front panel automatically scales the units for basic measurements (such as voltage, current and power parameters). For example, a measurement of 2,000 Watts is displayed as 2 kW. A measurement of 2,000,000 Watts is displayed as 2 MW. The meter makes these conversions using your PT and CT ratios.

The meter only performs automatic unit scaling if the displayed measurement is derived solely from the Power Meter module's output and the display units are set to default. See "Displays" on page 175 for more information.

Nameplate display and event log

Nameplate displays and event logs appear in ALT mode and are organized in tabular format. Nameplate displays show owner, meter and power system details:

```

OWNER                               Best Utility
TAG 1                               Substation 13A
TAG 2                               Main Feed 13kV
FW Rev, FEATURE SET                8650V110, A
BATTERY LIFE 96.9%  DIAG NUM        41/999
9:36:54 12/09/2010  ABC Q1  ALT  11m

```

The Event Log displays recent high priority events (you must use ION Enterprise or ION Setup to retrieve all logged event data):

```

DATE      TIME      EVENT      CODE
12/08/2010 10:23:45 Shutdown  SD25
12/08/2010 10:42:03 Power Up   SD25
12/08/2010 11:19:26 Changed Setup SD25
ADDITIONAL LOGS - READ THROUGH COMMS
9:36:54 12/09/2010  ABC Q1  ALT  11m

```

Histogram displays

Harmonic content is displayed in histogram format. The 2nd to the 63rd harmonics (31st on the ION8650C meter) are displayed in the histogram. The total harmonic distortion (THD) is displayed above the histogram.

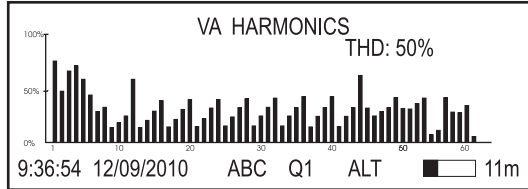

Phasor diagram displays

Phase information can be displayed in phasor diagram format. Phasor diagrams are accompanied by tables that show phase, voltage and current magnitudes. In cases where a phase vector is too small to be represented graphically, it is shown as a table entry only.

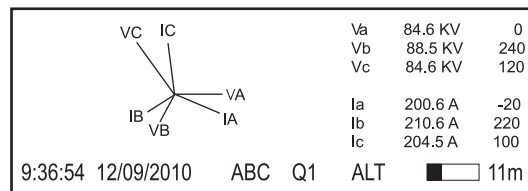

Disk simulator

This display simulates the behavior of a mechanical watt-hour meter indicating power received or delivered by the direction of the pulse.

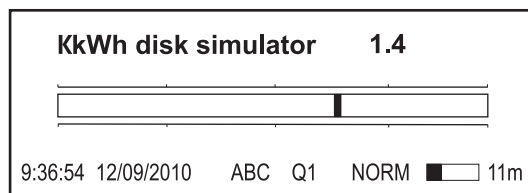

Time and date

This displays supports time and date formats, enabling displays with nothing but date and/or time and/or time remaining in the current interval.

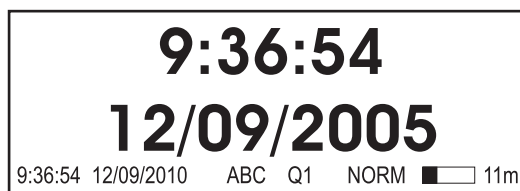

Time-stamped values

Up to three timestamped parameters can be displayed on the same screen. The timestamp indicates when the displayed parameter was last updated.

kW	block	peak	deliver	000001
				12/09/2010 7:30:00
kVA	block	peak	deliver	000002
				12/09/2010 7:30:00
kVAR	block	peak	deliver	000001
				12/09/2010 7:30:00
9:36:54	12/09/2010	ABC	Q1	NORM <input checked="" type="checkbox"/> 11m

Modes of operation

The meter has three modes of operation: NORM, ALT and TEST. Both NORM and ALT are display modes, providing various power system data and meter properties screens. TEST mode is used to perform diagnostics, verify the meter's accuracy, and verify meter functions.



NOTE

You can customize the display screens and alter the front panel's scrolling characteristics by editing the meter's Display and Scroll modules – refer to “DISPLAY SETUP menu” on page 36 for information on changing display settings and “Displays” on page 175 for information on customizing the displays.

Basic operation (NORM mode)

The meter defaults to NORM mode when powered up, and remains in this mode until you manually switch to ALT or TEST.

NORM mode screens are described in “NORM mode display screens” on page 183.

Meter configuration and NORM mode

- ◆ For meters *without* the hardware lock, all of the settings available in the front panel SETUP menu can be changed while the meter is in NORM mode, provided you have the correct password.
- ◆ For meters *with* the hardware lock, only the basic communications parameters in the COM Setup menu can be changed in NORM mode. You must enter TEST mode to change other meter parameters on the hardware-locked meter — see “Additional revenue metering security” on page 68 for more details.

ALT mode

ALT mode provides scrolling display screens that show power system data, billing information and meter properties such as nameplate information.

ALT mode screens are described in “ALT mode default display screens” on page 183.

Switching to ALT mode

Press the **ALT/ENTER** button to switch to ALT mode. Press the **ALT/ENTER** button again to switch back to NORM mode at any time. If no buttons are pressed, the meter automatically reverts to NORM mode after five minutes. As with any mode, pressing any button temporarily suspends display screen scrolling, allowing you to press the up or down arrow buttons to manually browse the available screens.

TEST mode



NOTE

If your meter has the optional hardware lock, you must remove the meter's cover to put it into TEST mode. See "Meter security features" on page 54 for more information.

TEST mode is typically used for meter function verification. The meter is usually reading data from a test power supply while these functions are performed.

All of the billing quantities that are recorded when the meter is in NORM and ALT mode stop accumulating when the meter is switched to TEST mode — the data is sent to special TEST mode registers instead. The values accumulated in these test registers are displayed on the front panel (and in the Vista component of ION Enterprise).

The regular NORM/ALT mode billing registers are unaffected while the meter is in TEST mode; accumulation of billing data resumes as soon as you exit TEST mode. All test registers are reset to zero when you exit TEST mode.

For detailed information on TEST mode, see "Switching to TEST mode" on page 189.



NOTE

The meter always returns to NORM mode when you exit TEST mode, even if you entered TEST mode from ALT mode.

Configuring the meter with the front panel

Using the meter's front panel, you can navigate through different menus to perform basic setup on your meter.



NOTE

If you have a hardware-locked meter, only the basic communications parameters can be changed in NORM mode. You must enter TEST mode to change other meter parameters on the hardware-locked meter. See "Additional revenue metering security" on page 68 for more details.

Accessing the SETUP menu

To access the SETUP menu, press and hold the front panel's **ALT/ENTER** button while the meter is displaying power system data. Within the SETUP menu is a list of sub-menus that contain the meter's configurable settings. The menu items are described in "Front panel features" on page 20.

Press the up or down arrow buttons to navigate through the menu. Highlight a menu item and press the **ALT/ENTER** button. When you select an item from the SETUP menu, you are presented with another menu of the settings in the meter. You may need to navigate several layers of menus to access the setting you want to change.

The following diagram shows how the buttons are used to navigate the menus:

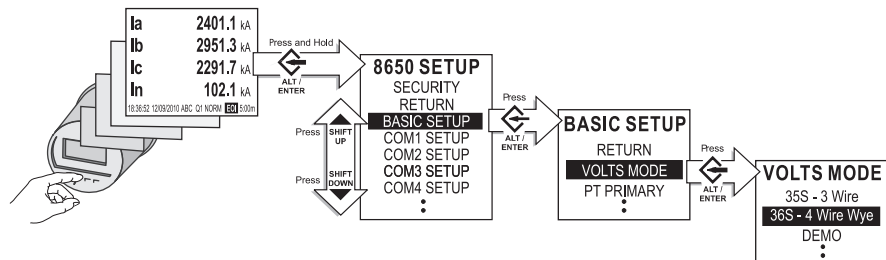

The settings contained in the SETUP menu are:

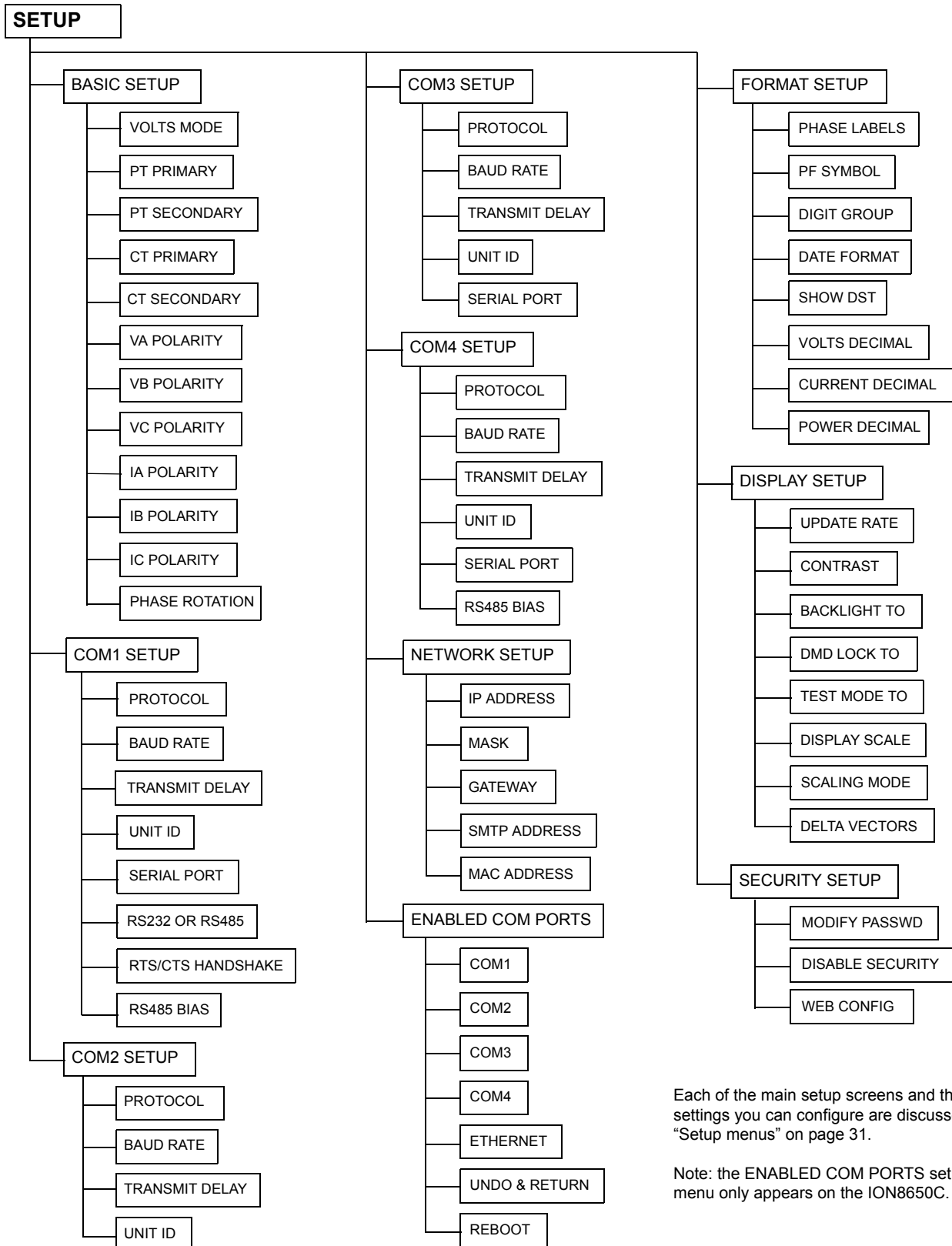

Each of the main setup screens and the settings you can configure are discussed in "Setup menus" on page 31.

Note: the ENABLED COM PORTS setup menu only appears on the ION8650C.

Navigating the front panel screens

Use the up and down arrow buttons to scroll through the menu items. When the setting you want to change is highlighted, press the **ALT/ENTER** button.

To return to a previous screen, use the up or down arrow button to highlight the RETURN menu item and then press the **ALT/ENTER** button.

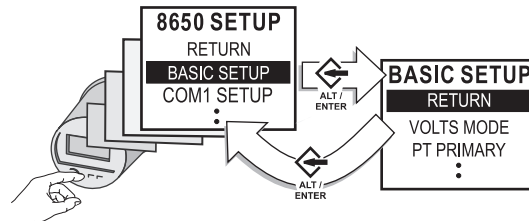

Configuring parameters using the navigation buttons

Use the up or down arrow buttons to change the value (if numeric) or the setting (if enumerated) of the highlighted parameter.

To change the position of the cursor, press the up or down arrow buttons for about one second. The up arrow button moves the cursor one position to the left and the down arrow button moves the cursor one position to the right. Once you have the value you want, press the **ALT/ENTER** button to select it.



NOTE

When setting Ethernet values (IP address, default gateway, etc.), press the up arrow button to insert additional digit spaces. Press the down arrow to remove digit spaces (see "NETWORK SETUP menu" on page 34 for more information).

OUT OF RANGE screen

When editing numeric data, the numbers displayed on the screen below MIN and MAX indicate valid entry bounds. If you enter a value outside valid bounds, you are presented with a message stating that the value is out of range. You can then either return to the register you were editing or choose to exit.



Confirming configuration changes

The CONFIRM CHANGE screen appears when you attempt to change the meter's settings through the front panel. This allows you to cancel an unwanted configuration change. The front panel also informs you when an entry is out of range. Select YES to confirm your change or NO to cancel it, then press the **ALT/ENTER** button to return to the previous setup screen.

Setup menus

The following sections describe the setup menus in more detail.

BASIC SETUP menu

The BASIC SETUP menu lets you set volts mode, potential transformer (PT) and current transformer (CT) ratios and various other settings (such as voltage and current polarities) so that you can ensure that your meter is adequately set for your application.

To access the BASIC SETUP menu with the meter's front panel:

1. Press and hold the **ALT/ENTER** button on the front panel of the meter. After about three seconds the SETUP screen appears.
2. Use the up or down arrow buttons to navigate to the BASIC SETUP menu. Press the **ALT/ENTER** button.
3. Press the up or down arrow buttons to navigate to the appropriate parameter, then press the **ALT/ENTER** button to edit the parameter.

Many of these settings are configured when the meter is initially put into service (the device will not operate properly until Volts mode and PT and CT ratios are set), but some settings may need to be changed to refine the device's operation.



NOTE

If you have a hardware-lockable meter, you must put the device into TEST mode prior to making changes to the BASIC SETUP parameters. For TEST mode information, see "TEST mode" on page 27.

The BASIC SETUP menu has the following settings:

Menu item	Setting options	Default	Description
Volts mode ¹	<ul style="list-style-type: none"> ◆ 9S - 4 Wire Wye/Delta ◆ 29S - 4 Wire Wye ◆ 35S - 3 Wire ◆ 36S - 4 Wire Wye ◆ Demo 	*See note	<p>The power system's configuration and supported form factor. 36S - 4 Wire Wye is only available on the socket meter.</p> <p>Note: The default setting varies depending on the meter form factor. Ensure you verify that the correct option is selected for your power system before putting the meter into service.</p>
PT Primary ¹	1.0 to 999999.00	120	The Potential Transformer's primary winding rating
PT Secondary ¹	1.0 to 999999.00	120	The Potential Transformer's secondary winding rating
CT Primary ¹	1.0 to 999999.00	5	The Current Transformer's primary winding rating
CT Secondary ¹	1.0 to 999999.00	5	The Current Transformer's secondary winding rating
VA Polarity	<ul style="list-style-type: none"> ◆ Normal ◆ Inverted 	NORMAL	The polarity of the Potential Transformer on V1
VB Polarity	<ul style="list-style-type: none"> ◆ Normal ◆ Inverted 	NORMAL	The polarity of the Potential Transformer on V2
VC Polarity	<ul style="list-style-type: none"> ◆ Normal ◆ Inverted 	NORMAL	The polarity of the Potential Transformer on V3

Menu item	Setting options	Default	Description
IA Polarity	◆ Normal ◆ Inverted	NORMAL	The polarity of the Current Transformer on I1
IB Polarity	◆ Normal ◆ Inverted	NORMAL	The polarity of the Current Transformer on I2
IC Polarity	◆ Normal ◆ Inverted	NORMAL	The polarity of the Current Transformer on I3
Phase Rotation	◆ ABC ◆ ACB	ABC	The expected rotation of the voltage phases (ABC or ACB)

¹ These registers are typically set when the device is commissioned. Changing the values of these registers while the device is in service is not recommended.

COM port setup menus

See “Communications options” on page 75 for more information on configuring meter communications.

To make changes to communications settings with the meter’s front panel, hold down the **ALT/ENTER** button for three seconds to enter the SETUP menu, then press the down arrow button to select the COM SETUP you want.

Depending on the communications options ordered with your meter, the following menu items are available:

Menu item	Description
COM1 Setup	Settings for the selectable RS-232 or RS-485 communications port.
COM2 Setup	Settings for the internal modem port.
COM3 Setup	Settings for the optical communications port located on the meter’s front panel.
COM4 Setup	Settings for the COM4 RS-485 port.
Network Setup	Settings for the Ethernet communications port.
Enabled COM Ports	Set which two COM ports are enabled for communication, in addition to COM3 (front optical port) which is always enabled. This menu is only available on the ION8650C.



NOTE

For hardware-locked meters, you do not need to be in TEST mode to alter these COM port settings.

Serial COM port settings

There are three main parameters that you must set or verify if your meter is connected to a serial network (including modem communications): *Unit ID*, *Baud Rate*, and *Protocol*.

**NOTE**

Other parameters such as TRANSMIT DELAY are used in advanced configuration or fine-tuning your system. The main parameters are the most common parameters required to get your meter communicating.

To configure the COM port settings:

1. Press and hold the **ALT/ENTER** button on the front panel of the meter. After about three seconds the SETUP screen appears.
2. Use the up or down arrow buttons to navigate to the COM port that you want to configure. Press the **ALT/ENTER** button.
3. Press the up or down arrow buttons to navigate to parameter you want to edit then press **ALT/ENTER**.
4. Use the up and down arrow buttons to change the value of the parameter then press **ALT/ENTER**.

The menu items, and their setting options and default configurations, are listed in the following table for COM1 (selectable RS-232 or RS-485), COM2 (modem), COM3 (optical port) and COM4 (RS-485).

Applies to...	Menu item	Setting options	Default	Description
All	Protocol	All COM ports: ION, Modbus RTU, Factory, DNP 3.00, GPS Arbiter ¹ , GPS Arbiter-Vorne ¹ , GPS:TrueTime/Datum ¹ Additional protocols on COM1 and COM4: Modbus Master ² , EtherGate ³ , ModemGate ³	ION	Specifies the protocol used by the communications port.
All	Baud Rate	300, 1200, 2400, 4800, 9600, 19200, 38400, 57600, and 115200 bps	9600 bps	Specifies the baud rate of the serial port. Ensure all devices on the same loop are configured to use the same baud rate.
All	Transmit Delay	0.0 to 1.0 s.	0.01s (10ms)	The amount of time in seconds that the meter waits for communications acknowledgements.
All	Unit ID	1 to 9999	COM1: Unit ID is based on the serial number ⁴ . COM2: 101 COM3: 102 COM4: 103	Sets the meter Unit ID. A unique Unit ID is required for each device (including all the devices on a ModemGate or EtherGate serial loop).
COM1	RS232 OR RS485	RS232 or RS485	RS485	Specifies the communications mode used by COM1.
COM1 (RS-232 only)	RTS/CTS Handshake	RTS/CTS or RTS with Delay	RTS with Delay	Specifies the flow control used by the communications port.
COM1 (RS-485 only) and COM4	RS485 Bias	OFF or ON	OFF	Enables or disables RS485 biasing. See "RS-485 biasing" on page 82 for more information.

Applies to...	Menu item	Setting options	Default	Description
COM1, COM3 and COM4	Serial Port	8O1, 8O2, 8N1, 8N2, 8E1, 8E2	8N1	Sets the parity and data format. For example, 8N1 is eight (8) data bits, no (N) parity bit and one (1) stop bit. Ensure that all devices on the same loop are set to the same format.

- ¹ See “Time synchronization” on page 119 for more details about GPS settings. See also the *Time Synchronization & Timekeeping* technical note for further details on using the meter’s time synchronization functions.
- ² Modbus Master is not available on the ION8650C.
- ³ See “Configuring Ethernet connections” on page 86 and “Internal modem connections” on page 91 for more details.
- ⁴ Unit ID for COM1 is based on the meter’s serial number. For example, if the serial number is PA-0009B263-01, the Unit ID is set in the factory to 9263.

NETWORK SETUP menu

There are two main parameters that you must set or verify if your meter is connected to an Ethernet network: IP address and subnet mask address.



NOTE

There are other parameters, such as GATEWAY ADDRESS and SMTP ADDRESS, that are used in advanced configuration or in fine tuning your system. The main parameters are the most common parameters required to get your meter communicating.

The menu items, and their setting options and default configurations, are as follows:

Menu item	Setting options	Default	Description
IP Address	0.0.0.0 to 255.255.255.255	None	Sets the IP address for the meter.
Mask	0.0.0.0 to 255.255.255.255	None	Used if subnet masking applies to your network – see your network administrator to determine if subnet mask is used.
Gateway	0.0.0.0 to 255.255.255.255	None	Used in multiple network configurations – see your network administrator to determine if gateway is used.
SMTP Address	0.0.0.0 to 255.255.255.255	None	Sets the IP address for the SMTP mail server that is configured to forward mail from the meter to the final destination – see your network administrator to determine if the SMTP mail server is used.
MAC Address	Read-only factory-set hexadecimal value	The MAC address is read-only and provided for information purposes only.	

Most network settings can be configured through the front panel; all network settings can be modified in ION Enterprise or ION Setup. See “Configuring Ethernet connections” on page 86 for more information.



NOTE

Configuring the IP ADDRESS, MASK, and GATEWAY settings incorrectly can cause network disruptions. See your network administrator for more information.

Typically, your network administrator provides you with the appropriate IP address for the meter. The subnet mask and gateway settings are only required if you have communications between multiple Ethernet networks and if subnetting is implemented.

Use the navigation buttons to edit the values of the network settings so that they match your system addresses. As you configure the network addresses, the front panel automatically discards unnecessary leading zeroes from each three-digit grouping. The hidden leading zeroes appear (and disappear again) as you move the position of cursor across the network address.

89.123.40.056

In the example above, the highlighted zero is discarded as soon as you change the position of the cursor.

ENABLED COM PORTS menu (ION8650C only)

Up to three COM ports can be active simultaneously on the ION8650C. COM3 (the front optical port) is always enabled. The ENABLED COM PORTS menu allows you to select the other two COM ports that you want enabled.



NOTE

A meter restart is required to change the enabled communications ports.

Menu item	Description
COM1	Specifies whether COM1 (RS-232/RS-485) is enabled or disabled.
COM2	Specifies whether COM2 (modem) is enabled or disabled.
COM3	COM3 (front optical port) is always enabled.
COM4	Specifies whether COM4 (RS-485) is enabled or disabled.
Ethernet	Specifies whether the Ethernet port is enabled or disabled.
Undo & Return	Exits the menu with no changes to the COM ports. No meter restart required.
Reboot	Restarts the meter. The changes are applied when the meter restarts.

The default settings vary depending on your order option. See your meter's *Installation guide* for details.

See "ION8650C communications options" on page 76 for details on changing the enabled COM ports.

FORMAT SETUP menu

The FORMAT SETUP contains the following values that set labeling and formatting preferences:

Menu item	Setting option	Default	Description
Phase Labels	ABC, 123, RWB, RYB, XYZ, or RST	ABC	Specifies how phases are labelled.
PF Symbol	LD/LG, +/-, or CAP/IND	LD/LG	Specifies the symbol pair used to indicate power factor.
Digit Group	1000.0, 1,000.0 or 1 000,0	1000.0	Numbers of three digits or greater can be grouped in any of the following three formats: 1000.0 (no commas, no spaces) or 1,000.0 (commas, no spaces) or 1 000.0 (no commas, spaces).
Date Format	YYYY/MM/DD, MM/DD/YYYY or DD/MM/YYYY	MM/DD/YYYY	Specifies how dates are displayed.
Show DST	Do not display DST or Display DST	Display DST	You can choose to display Daylight Savings Time (DST) or not.
Volts Decimal	1. to 123456789.XXX	1.XX	Number of decimal places displayed for voltage values (up to 9 digits before the decimal place and up to 3 digits after the decimal place).
Current Decimal	1. to 123456789.XXX	1.XXX	Number of decimal places displayed for current values (up to 9 digits before the decimal place and up to 3 digits after the decimal place).
Power Decimal	1. to 123456789.XXX	1.XXX	Number of decimal places displayed for power values (up to 9 digits before the decimal place and up to 3 digits after the decimal place).

DISPLAY SETUP menu

You can configure the following display preferences:

Menu item	Setting options	Default	Description
Update Rate	1s, 2s, 3s, 4s, 5s, or 6s	1s	The front panel can update its data from every one to every six seconds.
Contrast	0 to 9	5	A front panel display contrast level can be set from zero to nine where higher numbers represent a sharper level of contrast. You can adjust the contrast level at any time by pressing and holding down both up and down arrow buttons simultaneously.
Backlight TO	0 to 7200	300	Backlight timeout: this selection allows you to make the backlight turn off automatically after zero to 7200 seconds (two hours). If this value is set to 0 (zero), the backlight is always on.
DMD Lock TO	0 to 5184000	2160000	Demand lockout time (in seconds) controls the minimum allowable time between consecutive demand resets. You can select values from 0 (disabled) to 5184000 (60 days).
TEST mode TO	60 to 21600	1800	If there are no front panel key presses, the meter exits TEST mode automatically; the TEST mode timeout setting defines how long the meter remains in TEST mode before switching to norm mode. While in TEST mode, the value on the bottom right of the status bar indicates the amount of time before TEST mode times out.
Display Scale	1.0 to 999999.0	1000	Scale applied to values before they are displayed.

Menu item	Setting options	Default	Description
Scaling Mode	Multiply or Divide	Divide	Specifies whether values are divided or multiplied by the Display Scale before being displayed.
Delta Vectors	System or Instrument	Instrument	Specifies how vector diagrams are displayed when in Delta mode.

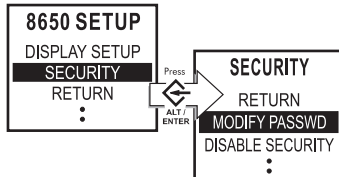

SECURITY menu

The settings in the front panel SECURITY menu allow you to:

- ◆ modify the existing meter password or reset it to the factory default.
- ◆ disable the password security check.
- ◆ enable web browser configuration on the meter.

You require the valid password to enter the SECURITY menu. The default password is 0 (zero).

See “Security” on page 53 for more details.



NOTE

The password enables users to change the configuration of the meter. It is recommended that you change your password from the default when you put the meter into service

If you have not yet entered your password, the meter’s front panel requires that you enter it before you can view the SECURITY setup menu. Use the navigation buttons to enter numerical data. If you enter an incorrect password, the front panel displays an invalid password message and you must try again.

Modify Password sub-menu

Use this sub-menu to change the password or to reset the password to the factory default (0).

From the meter’s front panel, select SECURITY, then MODIFY PASSWORD. Two choices appear: MODIFY PASSWORD or FACTORY DEFAULT. Use the Up button to select MODIFY PASSWORD or the Down button to select FACTORY DEFAULT.

Changing a password

- ◆ To change the value of a highlighted digit, use the up or down arrow buttons:
- ◆ To change the position of the cursor one space to the left, press the up arrow button for about one second.
- ◆ To change the position of the cursor one space to the right, press the down arrow button for about one second.
- ◆ When the correct password is displayed, press **ALT/ENTER**.

Disable Security sub-menu

Use this sub-menu to enable and disable password security on the meter. Disabling the password allows changes to all the meter's settings through the front panel without a security check.



NOTE

It is highly recommended that any meters in the field have the password security check enabled. Non-secure access to critical settings in the meter, such as PT and CT ratios, is not advisable.

When you re-enable password security, the password is reset to the factory default of 0 (zero). It is recommended that you re-enter a custom password at this point.

Disabling the Password Security Check is necessary to write to the meter when it is a Modbus slave device. See "The meter as Modbus slave" on page 99 for details about configuring your meter for third-party systems.

Web Config

Use this setting to enable/disable web browser configuration of the meter. See "Enabling and disabling web configuration" on page 58 for more details.

Chapter 4 Templates and firmware

Your meter comes installed with a preconfigured default template. This template contains various frameworks which provide all the power measuring and analyzing functionality of the meter. The default templates and frameworks can be used immediately without any user configuration. They can also be customized, reconfigured, and pasted from one meter to another.

For more information on templates, frameworks and ION modules, see the *ION Reference*.

Firmware is your meter's operating system. When newer firmware is available for your meter, simply upgrade to the latest version for all the added features and functionality.

In this chapter

◆ Factory information	40
Factory Module settings	40
How to TAG your meter	40
◆ Updating or restoring the template	41
Meter I/O module behavior	41
Using the front panel	41
Using ION Setup	41
Using Designer	42
◆ Upgrading your meter	44
General upgrading considerations	44
Upgrading to compatible firmware and template versions	44
Using a laptop computer to upgrade	44
Upgrading devices via a ModemGate connection	44
Meter behavior when an upgrade fails	45
Meter I/O module behavior	45
Upgrading firmware using ION Setup	45
Upgrading firmware using ION Enterprise	46
Before using Device Upgrader	46
Using Device Upgrader	46

Factory information

The Factory module displays firmware version, serial number and other device information in read-only setup registers (read-only registers can be viewed but not changed) or configurable information in read/write setup registers.

Factory Module settings

The device information provided is as follows:

Setup register	Description
Device Type	A device type identifier (for example, "8650" for the ION8650)
Compliance	A statement of whether the device is ION compliant or not
Options	Shows model number of meter
Revision	The meter's firmware version
Serial Num	The meter's serial number
ION Version	The ION version supported by the device
Template	The name of the template (framework) installed on the device at the factory
Nom Freq	The expected frequency of the power system being monitored
MAC Address	Media Access Control address ¹
Feature Set	The feature set of the meter (ION8650A, ION8650B or ION8650C)

¹ The MAC address of your meter cannot be changed, and is for information only.

The Factory module also holds the alternate PT and CT values, which can scale operational values on revenue-locked meters (see "Scaled operational values" on page 70) and numerous read-only setup registers that hold the calibration constants used at the factory.

How to TAG your meter

Three configurable read/write setup registers are provided for you to enter your company name and other text information you want stored in the meter:

- ◆ Owner - This is a text register for storing user information (for example, company name). It can be up to 255 characters in length.
- ◆ Tag 1 - This is a text register for storing user information (for example, device location). It can be up to 15 characters in length.
- ◆ Tag 2 - This is a text register for storing user information (for example, device number or identifier). It can be up to 15 characters in length.



NOTE

Tag 2, if entered, is used as the default MV-90 Device ID. Refer to the *MV-90 and ION Technology* technical note for more information.

Updating or restoring the template

You may need to update or restore the meter's template:

- ◆ If there is a new template with additional features or if you have configured one meter and want to configure others with the same settings.
- ◆ If you have made changes and want to return to the original configuration. The basic setup of the device can be retained, so the meter does not need to be taken out of service for a long period of time.



NOTE

If you restore the factory configuration, all recorded data and any custom features that you have created (such as custom alarms or custom data recorders) are lost.

Use ION Enterprise or ION Setup to upgrade or restore the template.

Meter I/O module behavior

The state of your meter's I/O modules may change during an upgrade. They will revert to previous settings after the upgrade is complete.

WARNING

HAZARD OF UNINTENDED OPERATION

- Do not use the meter for critical control or protection applications where human or equipment safety relies on the operation of the control circuit.
- Be aware that an unexpected change of state of the digital outputs may result when the supply power to the meter is interrupted or after a meter firmware or template upgrade.

Failure to follow these instructions can result in death, serious injury or equipment damage.

Using the front panel

You cannot restore the factory configuration from the meter's front panel.

Using ION Setup

1. Obtain the meter template that you want to update or restore:
 - ◆ Download your meter's factory template or an update template from www.schneider-electric.com.
 - ◆ Save a template you have configured on another meter. See the ION Setup Help for instructions.

Save the .DCF file. The default template file location is .../ION Setup/TEMPLATE.

2. Start ION Setup.

3. Open the Setup Assistant for your meter. See the ION Setup Help for instructions.
4. Select the Template screen.
5. Click the **Send to Meter** tab then click **Send**. The **Open ION8650 DCF file** dialog box appears. Navigate to the location where you saved the .DCF file.
6. Select the .DCF file and click **OK**. The **Template Paste Options** dialog box appears. Select the check boxes for the settings you want to retain (not overwrite) and click **OK**.

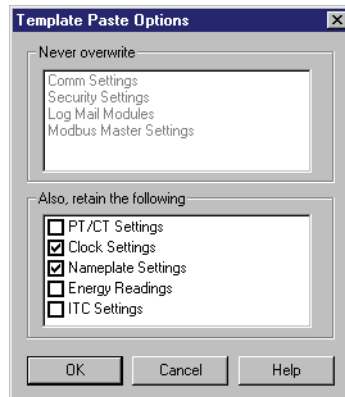

Rapid Meter Programming pastes the template onto your meter. A dialog box confirms the paste was successful.

Using Designer

See the *ION Enterprise help* for detailed instructions on updating and restoring templates and frameworks.



NOTE

The time required to complete the steps in this procedure can vary depending on your connection and the meter configuration. Some steps may take several minutes to complete.

1. Open your meter in Designer. Ensure that the meter's main Configuration screen is displayed.
2. Click **Edit > Select All** then press DELETE.

A confirmation dialog box appears explaining that some modules will not be deleted (core modules cannot be deleted — scroll down in the dialog to see which standard modules will be deleted).

3. Click **OK** on the confirmation dialog box.

The modules are deleted (other than persistent and core modules). You may get a message stating that persistent modules could not be deleted. Click Continue.

The main meter Configuration screen is blank except for a folder that contains the modules which cannot be deleted.

4. Click **Edit > Select All** to select the Frameworks folder. This selects all sub-folders and modules within the folder.

5. Click **Edit > Paste from Framework**, then select the appropriate .fwn file from the folder \ION Enterprise\config\fmwk\nd\. Click **Open**.

**NOTE**

The Factory module's Default Template register tells you the filename for the default factory framework. (For details about framework files, contact Technical Support or visit www.schneider-electric.com)

The **Paste Summary** dialog box appears.

6. Click on the first module, scroll down to the last module, hold the SHIFT key and click on the last module. This selects all of the modules.
7. Continue holding the SHIFT key and click on the check box to the left of the module name. A lock icon with a green check mark appears; this performs a lock-paste of the modules.

**NOTE**

Persistent modules can be overwritten in Designer. When pasting a default framework onto a meter, use lock-paste on the Persistent modules, not free-paste. A list of Persistent modules is available from Technical Support.

8. Select the **Maintain external inputs** check box and click **OK**.

A message appears indicating that Designer is pasting modules. All modules are selected when the paste is complete. Click anywhere in the background of the node diagram to deselect all of the modules.

9. Click the Power Meter shortcut in the Basic Configuration area to select it. Click the **Reset** icon or select **Edit > Reset**. This reverts the Power Meter to the settings it had before you deleted any modules (retaining your original basic setup).
10. Click **File > Send & Save**. If you receive a message stating that the operation is incomplete, click **Continue** then click **File > Send & Save** again.

Upgrading your meter

You can upgrade the firmware (operating software) and template on your meter using either ION Enterprise or ION Setup.

General upgrading considerations

Upgrading to compatible firmware and template versions

Ensure that the firmware version that you are upgrading to is compatible with your meter and that the version number is greater than your existing firmware (or else you will downgrade your meter).

Ensure that the template you are upgrading to matches the feature set of your meter (in other words, if your meter is an ION8650A, the template must be an A-variant template). The variant is indicated in the template filename.

You can download meter firmware and templates from www.schneider-electric.com.

Using a laptop computer to upgrade

Laptop computers generally have different default power properties than desktop computers. Incorrect power options can adversely affect device upgrading because the connection between the laptop and the device must be maintained in order to complete the upgrade successfully. If the laptop's hard disk shuts down or the laptop enters system standby mode, this connection is broken and the upgrade procedure must be restarted.

If you are upgrading a meter using a laptop computer, follow these guidelines:

- ◆ Plug the laptop computer into a wall outlet. Do not run the laptop on its battery.
- ◆ Configure the hard disks so that they do not shut down after a certain period of time (for example, set to "never").
- ◆ Turn off power suspension (for example, system stand-by) and hibernate options.
- ◆ Disable options that power down the laptop when it is closed. This prevents a shut down if the laptop is accidentally closed.
- ◆ Disable the screen saver; screen savers can burden the CPU.

Upgrading devices via a ModemGate connection

The maximum acceptable baud rate for upgrading via ModemGate is 56.6 kbps. Ensure that the baud rate on the ModemGate communications port and the baud rate on the meter to be upgraded are set to this or lower.

Meter behavior when an upgrade fails

The meter allows three consecutive attempts to upgrade the meter. If the third attempt fails, an error is generated and you must power cycle the meter before you try again. Wait 30 seconds for the meter to reset after power cycling it before you try to upgrade again.

Meter I/O module behavior

The state of your meter's I/O modules may change during an upgrade. They will revert to previous settings after the upgrade is complete.

WARNING

HAZARD OF UNINTENDED OPERATION

- Do not use the meter for critical control or protection applications where human or equipment safety relies on the operation of the control circuit.
- Be aware that an unexpected change of state of the digital outputs may result when the supply power to the meter is interrupted or after a meter firmware or template upgrade.

Failure to follow these instructions can result in death, serious injury or equipment damage.

Upgrading firmware using ION Setup

Performing a device upgrade in ION Setup involves:

- ◆ upgrading the device firmware, and
- ◆ upgrading the device template.

You can download your device's latest firmware and template from www.schneider-electric.com. Save the files in the .../ION Setup/TEMPLATE folder for easy access.

Upgrading the device firmware and template

In ION Setup:

1. Open the Setup Assistant for your meter. See the ION Setup Help for instructions.
2. Select the **Template** screen.
3. Click the **Firmware Upgrade** tab, then click **Upgrade**. Enter your meter password (if prompted) and click **OK**.



NOTE

If you want to retain customized meter template settings, other than those listed in the Template Paste Options dialog box (see Step 6), click on the **Save to PC** tab and click **Save**. Save your template as a .DCF file. Select this file in Step 5 instead of the file obtained from the website.

4. Browse to the .UPG file (device firmware) that you downloaded from the website and click **Open**. Type your ION Setup password when prompted and click **OK**.

5. Browse to the .DCF file (device template) that you downloaded from the website (or saved from your meter in Step 3) and click **Open**. The **Template Paste Options** dialog box appears.
6. Select the options that you **do** want to be retained and clear any options that you **do not** want to retain then click **OK**.
7. Track the progress of the upgrade.
After the firmware download is complete, ION Setup attempts to verify the firmware. If the verification fails, contact Technical Support.
8. Click **Exit** when you get a message that the upgrade is complete.

Upgrading firmware using ION Enterprise

ION Enterprise includes the Device Upgrader utility for upgrading devices.



NOTE

Supervisor-level access (level 5) is required to upgrade the device.

Before using Device Upgrader

Data stored in the meter's memory is lost during the firmware upgrade. This includes waveforms, Min/Max values, and information stored in the Data Recorder and Integrator modules. Ensure you save your meter's data before you upgrade your meter.

You need the applicable upgrade (.upg) files for your meter, which are available from www.schneider-electric.com. Save these files in a folder that is accessible from your ION Enterprise computer.

For more information about using Device Upgrader, refer to the ION Enterprise online help.

Using Device Upgrader

1. Stop the ION Log Inserter Service and the ION Virtual Processor Service.
2. Start Management Console.
3. Select **Tools > System > Device Upgrader**. Type your username and password in the login prompt.

A dialog box displays recommendations and warnings regarding the upgrade operation. Make sure you read and understand these warnings before you click **OK**. If you need to implement any changes because of the recommendations and warnings, close Device Upgrader, make the changes then re-open Device Upgrader and continue.

The Device Upgrader utility appears.

4. Select your meter type from the **List Devices of Type** box.

5. Select the appropriate meter from **Select Devices to Upgrade** box. To select multiple devices, hold down CTRL while clicking each device.
6. Click **Select File** in the **Select Revision** section. Locate and select the upgrade (.upg) file that you downloaded from the website, then click **Open**.
7. Select or clear the **Save/Restore Framework** check box (selected by default). If selected, this keeps a copy of your current framework template during the upgrade. After the firmware upgrade is complete, Device Upgrader restores your framework template.

**NOTE**

Device Upgrader loads new meter firmware that does not contain any framework templates. If you want to preserve customizations that you have made to your device framework, make sure you select **Save/Restore framework**. However, if you intend to replace the existing meter framework with a new one (for example, a new default meter template that you downloaded), clear **Save/Restore framework**. If you intend to replace the meter's framework configuration with a new template, it is recommended that you upgrade using ION Setup. See "Upgrading firmware using ION Setup" on page 45 for information.

8. Specify how Device Upgrader responds to an unsuccessful upgrade in the **Failure Handling** section (you only need to do this if you are upgrading multiple devices):
 - ◆ Select **Halt After**, then enter a number in the box to specify how many attempts you want Device Upgrader to make before stopping during an unsuccessful upgrade. By default, the utility is set to stop after the first unsuccessful upgrade.
 - ◆ Select **Ignore All** to attempt to upgrade all of the selected devices regardless of the number of devices that do not upgrade successfully.

**NOTE**

Firmware upgrade error codes are described in the ION Enterprise online help.

9. Click **Select File** in the **Select Revision** section. Navigate to the upgrade (.upg) file that you want to use and click **Open**.

This file will be downloaded to all the devices that are highlighted in the **Select Devices to Upgrade** list.
10. Click **Upgrade** to upgrade the selected device(s).

The **Upgrade Status** box shows each stage in the upgrade process. The completed progress bar indicates what percentage of the upgrade is complete. Each completed upgrade is noted in the Upgrade Status box.
11. Restart the ION Log Inserter Service and the ION Virtual Processor Service.

**NOTE**

If connection to the device is lost, or if power to the device is interrupted during an upgrade, restart the Device Upgrade utility procedure.

Chapter 5 **Basic setup**

This chapter explains how to perform basic meter setup using the front panel, ION Enterprise or ION Setup.

In this chapter

- ◆ **Introduction** **50**
 - Basic setup parameters 50
 - Configuring basic setup 51
 - Using the front panel 51
 - Using ION Setup 51
 - Using Designer 51

Introduction

Basic configuration of the meter is provided by the Power Meter module. The Power Meter module is the main connection between the power system measurements and all other ION modules in the device. This module reports the values for all voltage, current and power measurements. The Power Meter module's setup registers describe details of the power system being monitored.

Basic setup is typically performed when the meter is initially put into service, although the device cannot operate properly until the Volts Mode and PT and CT ratios are set. After this basic setup is performed the meter operates properly, and there is generally no need to make further changes to the basic setup.

Other advanced parameters can be configured, if needed. See the description of the Power Meter module in *ION Reference* for more information.

Basic setup parameters

Menu item	Setting options	Default	Description
Volts mode ¹	<ul style="list-style-type: none"> ◆ 9S - 4 Wire Wye/Delta ◆ 29S - 4 Wire Wye ◆ 35S - 3 Wire ◆ 36S - 4 Wire Wye ◆ Demo 	*See note	<p>The power system's configuration and supported form factor. 36S - 4 Wire Wye is only available on the socket meter.</p> <p>Note: The default setting varies depending on the meter form factor. Ensure you verify that the correct option is selected for your power system before putting the meter into service.</p>
PT Primary ¹	1.0 to 999999.00	120	The Potential Transformer's primary winding rating
PT Secondary	1.0 to 999999.00	120	The Potential Transformer's secondary winding rating
CT Primary ¹	1.0 to 999999.00	5	The Current Transformer's primary winding rating
CT Secondary ¹	1.0 to 999999.00	5	The Current Transformer's secondary winding rating
VA Polarity	<ul style="list-style-type: none"> ◆ Normal ◆ Inverted 	NORMAL	The polarity of the Potential Transformer on V1
VB Polarity	<ul style="list-style-type: none"> ◆ Normal ◆ Inverted 	NORMAL	The polarity of the Potential Transformer on V2
VC Polarity	<ul style="list-style-type: none"> ◆ Normal ◆ Inverted 	NORMAL	The polarity of the Potential Transformer on V3
IA Polarity	<ul style="list-style-type: none"> ◆ Normal ◆ Inverted 	NORMAL	The polarity of the Current Transformer on I1
IB Polarity	<ul style="list-style-type: none"> ◆ Normal ◆ Inverted 	NORMAL	The polarity of the Current Transformer on I2
IC Polarity	<ul style="list-style-type: none"> ◆ Normal ◆ Inverted 	NORMAL	The polarity of the Current Transformer on I3
Phase Rotation	<ul style="list-style-type: none"> ◆ ABC ◆ ACB 	ABC	The expected rotation of the voltage phases (ABC or ACB)
ScaleRevParam	<ul style="list-style-type: none"> ◆ ON ◆ OFF 	ON	Whether or not PT/CT correction is applied to displayed and recorded meter data

¹ These registers are typically set when the device is commissioned. Changing the values of these registers while the device is in service is not recommended.

Configuring basic setup

Use the front panel, ION Enterprise or ION Setup to perform basic meter setup.

Using the front panel

Access the BASIC SETUP menu to configure the power system settings. See “Front panel” on page 19 for instructions.

Using ION Setup

In ION Setup:

1. Open the Setup Assistant for your meter. See the ION Setup Help for instructions.
2. Select the **Basic Setup** screen and click the **PT/CT Ratios** tab.

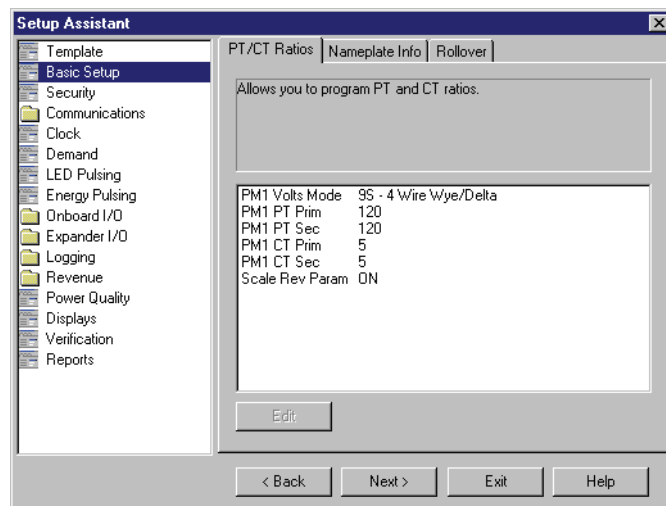

3. Configure each register as required by selecting the parameter and clicking **Edit**.



NOTE

Scaled Rev Param determines if the PT/CT correction is applied to displayed and recorded meter data. By default, Scaled Rev Param is set to ON and PT/CT corrections are applied.

Using Designer

Open your meter in Designer and navigate to the Basic Configuration Framework. Right-click on the Power Meter module to edit.

Chapter 6 Security

ION8650 meters offer standard and advanced meter security. Standard security is enabled by default from the factory. Advanced security allows you to configure more specific security settings, such as communications lockouts to limit the number of invalid login attempts, and to add up to 16 users, each with unique access privileges. Procedures for changing these security settings using the front panel, ION Enterprise or ION Setup are detailed in this chapter.

There are also security features available for revenue meters. The scaled operational values (SOV) feature, which allows scaling of non-revenue data on revenue-locked meters, is described in this chapter.

In this chapter

◆ Meter security features	54
Time synchronization security considerations	54
◆ Standard meter security	55
Configuring standard meter security using the front panel	55
Entering the password	55
Changing the password	56
Enabling and disabling the password security check	56
Resetting the password	57
Enabling and disabling web configuration	58
Configuring standard meter security in ION Setup	58
Configuring standard meter security in Designer	59
◆ Advanced meter security	60
Configuring advanced security using ION Setup	60
Step 1: Set basic security options	61
Step 2: Configure communications protocol lockout options	61
Communications protocol lockout examples	63
Step 3: Configure users	64
Configuring advanced security using ION Enterprise	66
Device security access for ION Enterprise services	67
◆ Additional revenue metering security	68
Hardware-lock security option	68
Locked module listings	69
Anti-tamper sealing methods	69
◆ Scaled operational values	70
Configuring scaled operational values	72

Meter security features

Your meter includes the following security features:

Standard meter security

Anytime you make configuration changes to your meter, you must enter a password. Standard security is enabled by default from the factory. See “Standard meter security” on page 55.

Advanced meter security

Advanced security allows you to:

- ◆ Enable or disable Modbus, front panel and web programming.
- ◆ Configure communications lockouts to limit the number of invalid login attempts permitted for each protocol and set the priority of associated meter events.
- ◆ Add up to 16 users, each with unique access privileges.

See “Advanced meter security” on page 60.

Revenue meter security

Your revenue meter can be protected by hardware-lock security and anti-tamper sealing. See “Additional revenue metering security” on page 68.

Software security

ION Enterprise or ION Setup software security brings access-level security to the meter. With ION Enterprise or ION Setup, you can configure multiple users with different passwords and specify access rights. ION Enterprise or ION Setup software security only applies to users who are accessing the meter using this software.

For more information on ION Enterprise or ION Setup software security, refer to the *ION system security* technical note.

Time synchronization security considerations

Depending on ION Enterprise or ION Setup security settings, a workstation that connects to an ION8650 device may send a time synchronization signal to synchronize the meter's internal clock with the workstation's clock. This can cause overlaps in the Demand intervals, and timestamps in the data logs may not be accurate.

The *Time Sync Source* setup register, located in the Clock module, identifies the only communications port that will accept time synchronization broadcasts. You can configure this setup register through ION Setup or through the Designer component of ION Enterprise.

Refer to the *Time Synchronization & Timekeeping* technical note for more information on implementing time synchronization.

Standard meter security

Standard meter security is enabled by default on all ION8650 meters; all configuration functions are password-protected.

- ◆ If you make configuration changes to the meter using the **front panel**, the meter prompts you for its password before accepting any configuration changes. You do not need to re-enter the password for each subsequent change. However, if you perform no additional configuration changes for five minutes, the meter exits setup mode; to make any further changes, you will need to re-enter the Setup menu and provide the valid meter password.
- ◆ If you make any configuration changes using ION Setup or ION Enterprise **software**, you are prompted by the meter for its password (in addition to the password used to access the software).

After you enter the correct meter password and confirm the new configuration, the change is set on the meter.

The default meter password is 0 (zero). It is recommended that you change this password before putting the meter into service.

Configuring standard meter security using the front panel

This section describes the password security options available to front panel users. Step by step instructions are provided on the following procedures:

- ◆ Entering the meter password.
- ◆ Changing the meter password.
- ◆ Disabling (and enabling) the password security check.

Entering the password

The first time you attempt to change any setting, you are presented with the password screen (shown below). After you enter the correct password, you do not have to re-enter it for other any other changes unless you exit the configuration session.

ENTER PASSWD
00000000
MIN: 00000000 MAX: 99999999
HOLD ARROW KEY TO MOVE CURSOR

To enter the password:

1. Use the arrow buttons to change the value of the highlighted digit. The up arrow increments the number and the down arrow decrements it.

2. Hold down an arrow button for about one second to change the position of the cursor. The up arrow moves the cursor left one position and the down arrow moves the cursor right one position.
3. Press the **ALT/ENTER** button once you have the value that you want.

Changing the password

By default, the password is set to 0 (zero) in the factory. The password can be changed to any number up to eight digits long. It is highly recommended that you change the password from the default value.

To change the password:

1. Hold down the **ALT/ENTER** button to access the SETUP menu.
2. Use the up and down arrows to highlight SECURITY then press the **ALT/ENTER** button.
3. Use the up and down arrows to highlight MODIFY PASSWD then press the **ALT/ENTER** button.
4. Enter the current meter password when prompted (see “Entering the password” on page 55). After you enter the password, you are able to modify the password:

MODIFY PASSWD

00000004

MIN: 00000000 MAX: 99999999

HOLD ARROW KEY TO ADVANCE CURSOR

5. Use the up and down arrow buttons to change the value of the highlighted digit. The up arrow increments the number and the down arrow decrements it.
6. Hold down an arrow button for about one second to change the position of the cursor. The up arrow moves the cursor left one position and the down arrow moves the cursor right one position.
7. Press the **ALT/ENTER** button once you have the value that you want. You are prompted for your current password before the new password is saved.

Enabling and disabling the password security check

Disabling the password security check allows changes to all the meter's settings through the front panel and software without a security check. This procedure may be necessary in some rare cases (for example, if the communications interface you are using does not support the meter's security protocols).



NOTE

It is highly recommended that any devices in the field have the password security check enabled. Non-secure access to critical settings in the meter, such as PT and CT ratios, is not advisable.

Disabling the password security check

To disable the password security check:

1. Press the **ALT/ENTER** button to enter the SETUP menu.
2. Use the arrow buttons to scroll down the menu and select SECURITY, then press **ALT/ENTER**.
3. Enter the valid meter password at the password prompt. You are then presented with the SECURITY menu.
4. Use the arrow buttons to scroll down the menu and select DISABLE SECURITY then press the **ALT/ENTER** button.
5. Select PROCEED, then select YES at the prompt to confirm the change.

Your meter's password is now disabled; changes to settings in the meter do not require a valid password. To re-enable the password security check, see "Enabling the Password Security Check", below).

6. Press the **ALT/ENTER** button to return to the SETUP menu.

Enabling the password security check

When you re-enable the password security, you are required to enter a new password.

To re-enable password security:

1. Press the **ALT/ENTER** button to enter the SETUP menu.
2. Use the arrow buttons to scroll down the menu and select SECURITY, then press **ALT/ENTER**.
3. Select MODIFY PASSWD then press the **ALT/ENTER** button.

The message FAC DEFAULT appears in the middle of the screen. If you want to use the factory default password, press the **ALT/ENTER** button. If you want to set the password to a different number, use the instructions in "Changing the password" on page 56.

4. Press the **ALT/ENTER** button after you enter your new password.
5. Select YES to confirm the change and return to the SETUP menu.

The password security check is re-enabled, and all changes to the device's configuration require the new meter password.

Resetting the password

In the event that you forget or lose your meter password, you can reset the password to the factory default value of 0 (zero). Resetting the password requires that the meter be in TEST mode.

- ◆ If your meter has the password security check **disabled**, you can put the meter into TEST mode using ION Enterprise or ION Setup.
- ◆ If your meter has the password security check **enabled** (or your meter has the hardware lock security option), you must remove the meter's outer cover to access the TEST mode button.

Refer to “Switching to TEST mode” on page 189 for details on putting the meter into TEST mode.

Follow these instructions to reset the password to the factory default:

1. Put your meter into TEST mode.
2. Press and hold down the **ALT/ENTER** button and the demand reset switch simultaneously.

A message appears on screen stating that the password has been reset to the default. Password security is now enabled and the meter password is 0 (zero).

Enabling and disabling web configuration

By default, remote configuration of the device via web browser is enabled. Follow these steps to enable or disable the ability to configure your meter over the web:

1. Press the **ALT/ENTER** button to enter the SETUP menu.
2. Use the arrow buttons to scroll down the menu and select SECURITY, then press **ALT/ENTER**.
3. Enter the valid meter password at the password prompt. You are then presented with the SECURITY menu.
4. Use the arrow buttons to scroll down the menu and select WEB CONFIG, then press the **ALT/ENTER** button.
5. Select ENABLED or DISABLED as appropriate then press **ALT/ENTER**.
6. Select YES to confirm the change and return to the SETUP menu.

Configuring standard meter security in ION Setup

In ION Setup:

1. Open the Setup Assistant for your meter. See the ION Setup Help for instructions
2. Select the **Security** screen.
3. Select *Security Mode* from the **Security** tab and click **Edit**. The **Open File** dialog box appears.
4. Select the Standard.scf file and click **Open** to edit. The **Standard Options** dialog box appears.
5. Select the check boxes of the security options you want to enable. Some options may be unavailable because of existing security settings.

To change the password, enter a new meter password and then confirm it by entering it again.

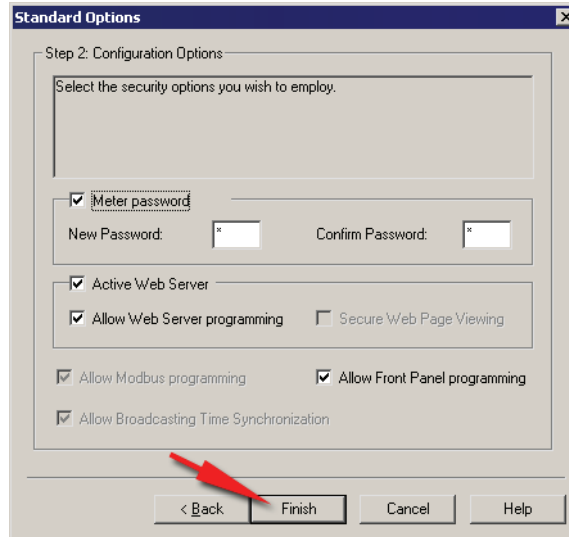

NOTE

Changing communications port settings with the **Allow Front Panel programming** check box cleared (unchecked) can cause loss of communications with your meter and render it inoperable. In this case a factory reconfiguration of your meter is required, which resets your meter to its factory defaults and destroys all logged data.

6. Click **Finish** when you are done. A prompt appears asking if you want to save your security settings in a file.
 - ◆ Click **Yes** to save the settings. Enter a new name for your security file (you cannot use Standard.scf) and click **Save**.
 - ◆ Click **No** if you want to cancel the changes you made.

Configuring standard meter security in Designer

1. Open your meter in Designer. Ensure that you log in with Supervisor access and that the Toolbox is displayed.
2. Select **Options > Change Standard Meter Security**.
3. Enter the meter password when prompted. You must enter the existing meter password before you can change security settings (the default is zero).
4. Type a new numeric password in the Password field and confirm it by re-typing the password in the Confirm Password field. If you are sure you want to disable standard security, select the **Disable Standard Meter Password** check box.



NOTE

Do not disable security unless it is absolutely necessary. Disabling standard security leaves your meter configuration open to tampering (intentional or unintentional) through communications and the front panel.

Advanced meter security

Advanced meter security is available on ION8650 meters. Advanced security allows you to:

- ◆ Enable or disable Modbus, front panel and web programming.
- ◆ Add up to 16 users, each with unique access privileges.
- ◆ Configure communications protocol lockouts to limit the number of invalid login attempts permitted for a user using a particular password, protocol and communications method combination and set the priority of login-related meter events.



NOTE

Use ION Enterprise or ION Setup (version 1.1 and later) to configure advanced security. ION Setup has a Setup Assistant that guides you through advanced security setup.

Entering an advanced security user name and password

When you attempt to view data or make a change to a meter that has advanced security enabled, you are prompted for a user name and password.

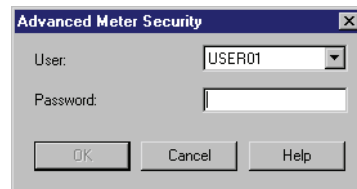

1. Select a user or enter a valid advanced security user name.



NOTE

User names are fixed as USER01 through to USER16.

2. Enter the appropriate password and click **OK**.

Configuring advanced security using ION Setup

In ION Setup:

1. Open the Setup Assistant for your meter. See the ION Setup Help for instructions.
2. Select the **Security** screen.
3. Select **Security Mode** from the **Security** tab and click **Edit**. The **Open** dialog box appears.
4. Select the Advanced.scf file and click **Open** to edit. The **Advanced Options** dialog box appears. Use the screens to configure:

- ◆ Basic security options, such the front panel password and whether or not web programming is allowed. See “Step 1: Set basic security options” on page 61.
- ◆ Communications protocol lockout settings. See “Step 2: Configure communications protocol lockout options” on page 61.
- ◆ Users and their access rights and passwords. See “Step 3: Configure users” on page 64.

Step 1: Set basic security options

1. Select the check boxes of the security options you want to enable. Some options may be unavailable because of existing security settings. To change the front panel password, enter a new meter password and then confirm it by entering it again.

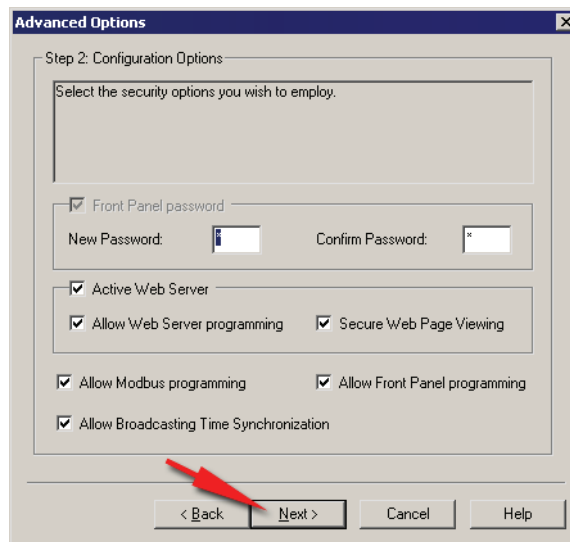

NOTE

Changing communications port settings with the **Allow Front Panel programming** check box cleared (unchecked) can cause loss of communications with your meter and render it inoperable. In this case a factory reconfiguration of your meter is required, which resets your meter to its factory defaults and destroys all logged data.

2. Click **Next**. The **Select protocol lockout options** screen appears; see “Step 2: Configure communications protocol lockout options” on page 61.

Step 2: Configure communications protocol lockout options

The communications protocol lockout advanced security feature allows you to set the number of invalid login attempts each user (in this case, user is a single user and password combination) can make using a particular protocol and communications method before being locked out. For session-based (such as ION and HTTP), you can configure how often the meter registers invalid login attempts. You can also configure the lockout duration for all configurable protocols.

Once a user is locked out, the meter will not accept login attempts from that user on that protocol and communications method until the lockout duration has passed. For example, once USER01 has been locked out using ION over Ethernet, USER01 cannot access the meter using ION over Ethernet until the lockout duration has passed, even if USER01 enters the correct password. However, if the user enters the correct USER/password combination before being locked out, the invalid attempt counter is reset to 0.

You can also configure the event priority for meter access and protocol lockout events, so that they can be viewed in the meter's event log.

Configuring communications protocol lockout

See “Communications protocol lockout examples” on page 63 for examples of how these settings affect login and communications.

1. Select the check boxes beside the protocols for which you want to enable communications protocol lockout.
2. Highlight a selected protocol and click **Edit** to modify the lockout values for that protocol.
 - ◆ Invalid logins specifies the number of invalid login attempts allowed per user/password combination before access is denied to that user using that protocol and communications method.
 - ◆ Session timeout specifies the active session duration for a protocol; during this time, repeated invalid login attempts using the same USER/password combination are not registered (repeated invalid attempts with different combinations are still registered). This only applies to session-based protocols which send credentials with each packet. Configuring this setting prevents accidental lockouts and the meter's event log from being filled with protocol access events, if logging of these events is enabled.

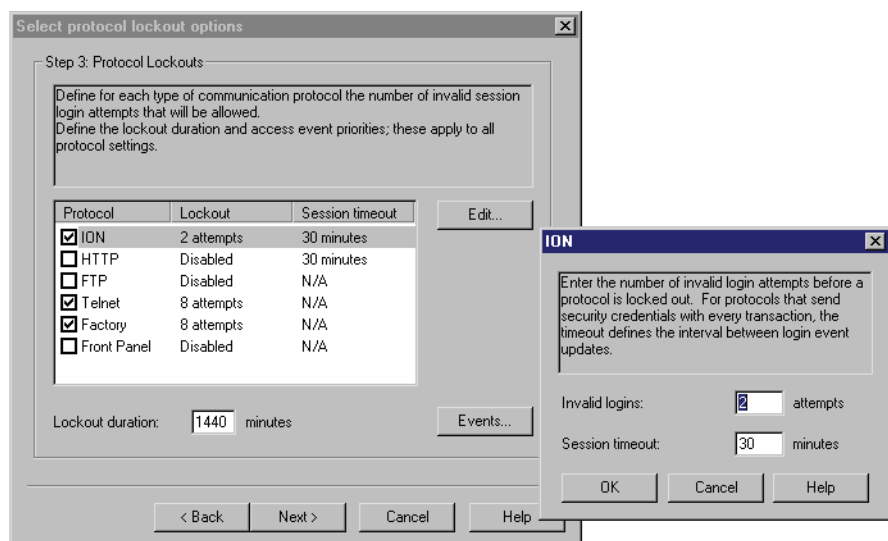

Click **OK**. Repeat for all protocols on which you want to enable communications protocol lockout.

3. Type the lockout duration, in minutes. The lockout duration specifies how long the meter ignores communication attempts by a user that is locked out. The lockout duration value applies to all lockout-enabled protocols.

Once a user is locked out, the user cannot access the meter using the same protocol and communications method, regardless of whether or not the user enters the correct USER/password combination.
4. Click **Events** to enter the event priority for valid login attempts, invalid login attempts and protocol lockouts. The event priorities apply to all lockout-enabled protocols. Enter 0 (zero) to disable event logging for a particular type of login attempt.
5. Click **Next**. The **Define individual users/passwords** screen appears. See “Step 3: Configure users” on page 64.

Communications protocol lockout examples

In the following examples:

- ◆ The configured users and their valid passwords are:
 - ◆ USER01/password 11
 - ◆ USER02/password 22
- ◆ For the ION protocol:
 - ◆ Protocol Lockout is configured to allow 3 invalid login attempts by a particular user/password combination before locking the user out.
 - ◆ Session timeout is set to 30 minutes.
- ◆ For all protocols that can be locked out:
 - ◆ Lockout duration is set to 1440 minutes (one day).
 - ◆ The meter is configured to log invalid event entries.

Scenario 1

This example illustrates what happens when a user repeatedly enters the same incorrect password when attempting to access the meter.

1. An access attempt is made using ION over Ethernet by USER01 but with a password of 0.

The user is informed of the invalid attempt and cannot access the meter. The invalid attempt is logged in the event log and the counter of invalid attempts is incremented to 1.
2. The user attempts to access the meter again 10 minutes later with USER01/ password 0.

The user cannot access the meter but the event is not logged and the counter of invalid attempts is not incremented, because the session timeout has not elapsed.
3. The user attempts to access the meter again with the invalid USER01/password 0 combination 30 minutes after the initial attempt.

Because the session timeout has elapsed, the event is logged and the counter of invalid login attempts is incremented to 2.

- ◆ If the user attempts to login again after 30 minutes has elapsed with the same invalid USER01/password 0 combination, the event is logged and the counter of invalid attempts is incremented to 3. USER01 is locked out for the duration of the lockout time (1440 minutes), and cannot connect to the meter using ION over Ethernet, regardless of whether or not they subsequently try to login with the correct user/password combination. That USER can access the meter through another communications method (for example, ION over serial) if they enter the correct USER/password combination.
- ◆ If the user attempts to login with USER01/password 11, the access is allowed and the invalid login counter is reset to 0.

Regardless of the invalid attempts of USER01, USER02 can access the meter using ION over Ethernet if they enter the correct password; they are not affected by the lockout.

Scenario 2

This example illustrates what happens when different invalid combinations of user and password are entered.

1. An access attempt is made using ION over Ethernet by USER01 but with a password of 0.

The user is informed of the invalid attempt and cannot access the meter. The invalid attempt is logged in the event log and the counter of invalid attempts is incremented to 1.
2. The user attempts to access the meter again with USER01/password 3.

The user is informed of the invalid attempt and cannot access the meter. In this case, this is considered a new invalid attempt because it is a different combination of user and password. It is logged in the event log and the counter of invalid attempts is incremented to 2.
3. The user attempts to access the meter again with USER01/password 4.

The user is informed of the invalid attempt and cannot access the meter. Once again, this is considered a new invalid attempt and it is logged in the event log and the counter of invalid attempts is incremented to 3.

USER01 is locked out for the duration of the lockout time (1440 minutes), and cannot connect to the meter using ION over Ethernet, regardless of whether or not they subsequently try to login with the correct user/password combination. USER01 can access the meter through another communications method (for example, ION over serial) if they enter the correct USER/password combination.

Regardless of the invalid attempts of USER01, USER02 can access the meter using ION over Ethernet if they enter the correct password; they are not affected by the lockout.

Step 3: Configure users

Advanced security allows configuration of up to 16 users, each with unique access rights to the meter.

1. Select the check boxes of the users you want to configure (USER01 through USER16). Select the appropriate access for each user:

- ◆ **Timesync:** set the time on the meter.
- ◆ **Read:** view any parameter except the security configuration.
- ◆ **Peak Demand Reset:** perform a reset of peak demand values (for example, sliding window demand for kW, kVAR, kVA etc.).
- ◆ **TEST Mode:** put the meter into Test mode.
- ◆ **Full Meter Configuration:** configure any programmable register on the meter except for registers related to the security setup, registers that result in a demand reset, or actions that place the meter in Test mode.
- ◆ **Security Configuration:** configure advanced security for the meter; full meter configuration must also be set to YES.

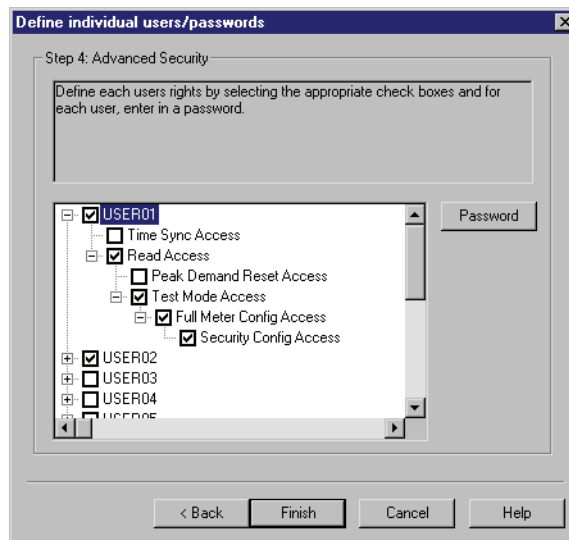

When configuring users, in most cases, you must set Read access to YES. However, you can set up a user without read access; for example, you can create a user who can only timesync the meter. In some cases (such as advanced security configuration access), you must set multiple access options to YES. When you are configuring advanced security, the software rejects unacceptable or unsecure user configurations.

2. Select a user, then click **Password** to set a password for that user. Type the password in the **New password** and **Confirm new password** fields and click **OK**.

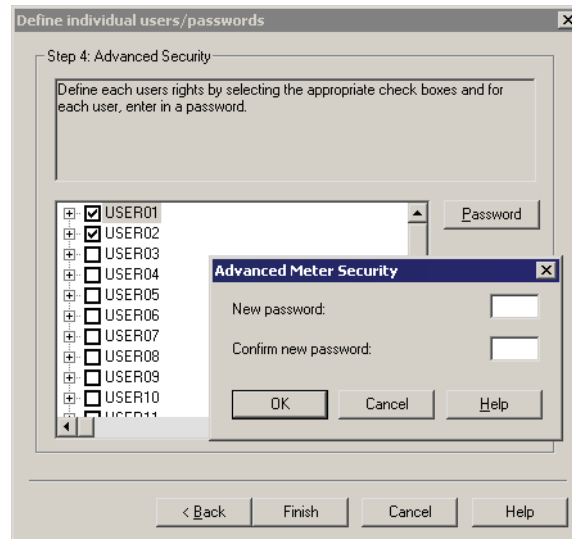

3. Click **Finish** when you are done configuring users. A prompt appears asking if you want to save your security settings in a file.
 - ◆ Click **Yes** to save the settings. Enter a new name for your security file (you cannot use `Advanced.scf`) and click **Save**.
 - ◆ Click **No** if you want to cancel the changes you made.

Configuring advanced security using ION Enterprise

1. Open your meter in Designer. Ensure that you log in with Supervisor access and that the Toolbox is displayed.
2. If you do not want to allow front panel programming using the standard security meter password, double-click on the Display Options module and change the Front Panel Programming register to disallowed.

If you allow front panel programming when you set up advanced security, the meter password (used in standard security) is still active through the front panel. You may need to allow front panel programming if someone installs the meter in the field and needs to make setup modifications. After the meter is installed, you can disallow front panel programming so that advanced security user names and passwords must be used to view or change meter information.



NOTE

Changing communications port settings with the **Allow Front Panel programming** setting disabled can cause loss of communications with your meter and render it inoperable. In this case a factory reconfiguration of your meter is required, which resets your meter to its factory defaults and destroys all logged data.

3. Double-click on the Meter Security Setup folder.

For each user that you want to configure, drag out a Security User module from the Toolbox and modify the appropriate access level setup registers.
4. Click **Change Password** at the bottom left of the module setup screen to configure a password. The default password is 0 (zero).

Click **OK** after you configure the user settings.

5. Right-click on the Security Options module.
6. Double-click the setup register you want to edit and use the dropdown menu to change the register setting.

You must set the *Enable Advanced Security* register to Enabled. Refer to the Security Options module description in the *ION Reference* for more details.

After you configure the security options, click **OK**.

7. Click **File > Send & Save**. Advanced security is now enabled on the meter.

Device security access for ION Enterprise services

If you are using your meter with ION Enterprise, many ION Enterprise services need constant access to the meter. These services include the ION Log Inserter Service, the ION Virtual Processor Service and ION Site Service.

When advanced meter security is enabled, these services may not have sufficient access rights to perform their operations. You must specify a user with sufficient access rights for these services.

For more information on these services, see the online ION Enterprise Help.



NOTE

You can configure a separate user for accessing services. If you encounter difficulties with ION Enterprise accessing the meter, it is likely that these services either do not have access rights or the original user name and password have changed. The user configured to allow the services access to the meter may also be locked out as a result of invalid login attempts; see "Advanced meter security" on page 60.

Allowing ION Enterprise services access to meters with advanced security enabled

1. Start Management Console and click **Devices** in the System Setup Pane.
2. Select the device (or select multiple devices) that has advanced security enabled, right-click and select **Security**. The **Meter Security Settings** dialog box appears.
3. Select the username you want from the dropdown list. The **Change Password** button becomes active. Select the check box if you want to allow this user to send time synchronization signals to the meter. Click **OK**.
4. Enter the valid password, re-type the password to confirm and click **OK**.

Allowing ION Enterprise services access to meters with standard security enabled

ION Enterprise services can automatically access meters with standard security when the meter is added to Management Console.

Additional revenue metering security

To meet government regulations and utility security requirements, the ION8650 revenue meter incorporates additional security elements:

- ◆ a hardware-locked security system that prevents modification of revenue quantities after the meter is sealed.
- ◆ traditional anti-tamper mechanical seals on the meter base unit and reset switch.

Hardware-lock security option

The hardware-locked security feature is an ordering option for some ION8650 meters that locks the ION module parameters specific to revenue data, so that these parameters cannot be altered. This hardware lock is factory set. To make configuration changes to billing parameters on a hardware-locked meter, you must first place the meter into TEST mode. The TEST mode button is located under the anti-tamper sealed outer cover, and the cover must be removed to access the TEST mode button. This button cannot be activated remotely with a hardware-locked meter.

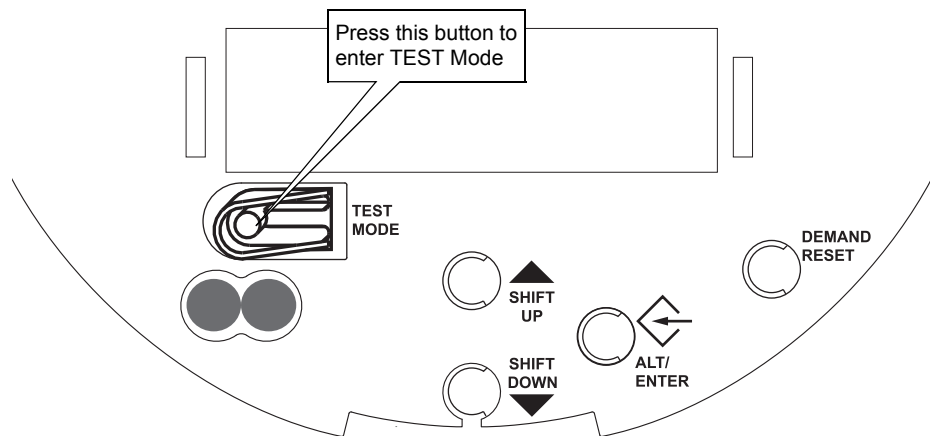

The hardware-lock option, when combined with standard and advanced security (front panel password) and physical anti-tamper sealing, offers the highest level of security. Hardware-locked meters operate as follows:

- ◆ With the meter in Normal mode, and with standard or advanced security applied, ION modules that generate revenue data are locked and cannot be altered. Users can modify unlocked ION modules depending on their level of password-protected access through software or the front panel.
- ◆ With the meter in TEST mode (which requires removing the cover and breaking the anti-tamper seals), users can modify ION modules depending on their level of password-protected access through ION Enterprise, ION Setup or the front panel.

Typical values that are hardware locked include:

- ◆ kWh, kVARh, kVAh delivered, received, del-rec, del+rec.
- ◆ kW, kVAR, kVA Sliding Window demand min and max values.

- ◆ Digital Outputs controlling the energy pulsing applications.
- ◆ All Power system settings, including PT and CT ratios.

Locked module listings

For a complete list of locked modules specific to your meter and its firmware, see the *ION Device Template Reference*.

Anti-tamper sealing methods

The following sections describe the anti-tamper sealing methods used by the ION8650 meter.

Demand reset switch seal

The demand reset switch located on the front panel can be sealed by a wire seal or lock inserted through the side of the switch. This seal does not have to be broken to remove the meter's cover.

Socket seals

A standard ANSI C12.7 type socket-sealing ring can be in place to hold the meter to the socket. When removing the outer cover, the sealing ring must first be removed. Some socket sealing rings facilitate wire seals.

Outer cover seals

The outer cover of the meter is factory sealed to its backplate with a T-type seal. Depending on the installation, this seal may be inaccessible after the meter is installed until you remove the device from the socket.



NOTE

In certain countries the meter is no longer revenue certified if the anti-tamper seals are broken.

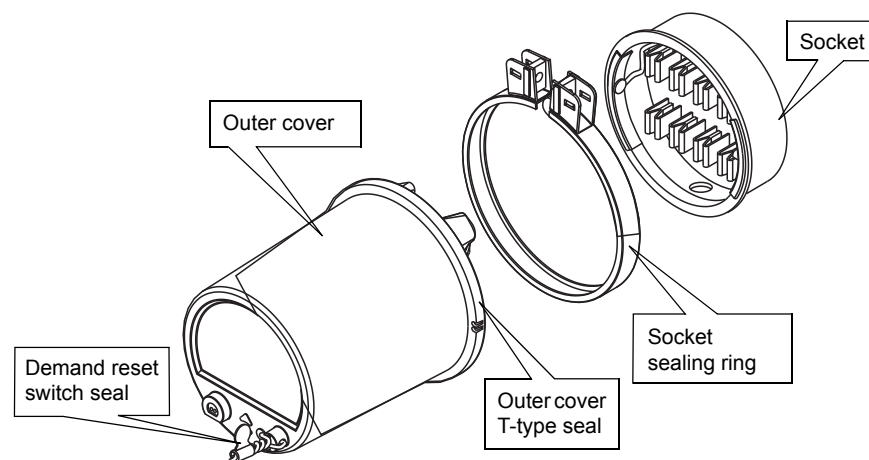

Scaled operational values

The scaled operational values (SOV) feature is intended for hardware-locked meters where the Power Meter module's PT and CT ratios are 1:1.

The SOV feature allows you to enter alternate PT and CT values through the Vista component of ION Enterprise, in order to obtain scaled non-revenue data for analysis. The alternate scaling registers are stored in the Factory module and have a default value of 1.

The Power Meter module's PT and CT primary and secondary values are compared against the Factory module's alternate values by a series of Arithmetic modules. The Arithmetic modules determine if the SOV feature is enabled (the Power Meter module's scaling ratios are all 1:1).

- ◆ If the SOV feature is disabled, the Arithmetic modules output the Power Meter module's PT, CT, and kVA ratios.
- ◆ If the SOV feature is enabled, the Arithmetic modules output the alternate PT, CT, and kVA ratios. These ratios are applied to the outputs of the MU (Metering Units) Power Meter module to generate scaled operational values. The scaled operational values can be viewed and analyzed using the Vista and Web Reporter components of ION Enterprise.



NOTE

Scaled operational data can only be accessed through ION Enterprise.

The following diagram shows how scaled operational values are generated.

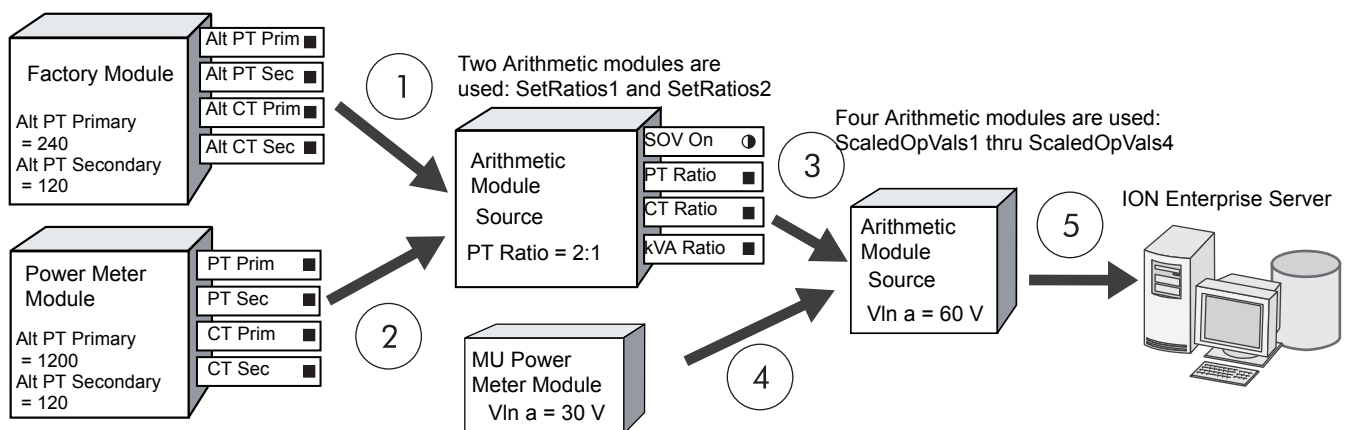

1. Alternate PT and CT primary and secondary values are loaded into the first series of Arithmetic modules.
Example: Alternate PT Primary = 240, Alternate PT Secondary = 120
2. Power Meter PT and CT primary and secondary values are loaded into the first series of Arithmetic modules.
Example: PT Primary = 120, PT Secondary = 120

**NOTE**

All the Power Meter module's ratios must equal 1:1 to enable the SOV feature.

- Because the Power Meter module's ratios are 1:1, the alternate scaling registers are used to generate the PT, CT, and kVA ratios, which are loaded into the second series of Arithmetic modules.

Example: PT ratio = 2:1

- MU Power Meter module per phase voltage, current and energy values, and total/average voltage, current and energy values are loaded into the second series of Arithmetic modules.

Example: VLN a = 30 V

- The second series of Arithmetic modules apply the PT, CT, and kVA ratios to the MU Power Meter values to output operational scaled values to your ION Enterprise database.

Example: VLN a = 60 V

The following 1-second data values are scaled by the SOV feature.

VIn a	VIn b	VIn c	VIn avg	VII ab
VII bc	VII ca	VII avg	I a	I b
I c	I avg	kW a	kW b	kW c
kW total	kVAR a	kVAR b	kVAR c	kVAR total
kVA a	kVA b	kVA c	kVA total	

The following are derived from scaled operational data values:

- ◆ Maximum/minimum,
- ◆ Historic high/low/mean, and
- ◆ Waveforms.

**NOTE**

The Sag/Swell and Transient modules are not affected by the SOV feature. The nominal voltage register in the Sag/Swell module must be set to the unscaled voltage value.

The Harmonics Measurement module outputs are only scaled by the SOV feature when the *Display Mode* register is set to **Engineering units**. No other harmonics modules are affected.

Because total harmonic distortion (THD), total even harmonic distortion (TEHD) and total odd harmonic distortion (TOHD) are expressed as **percentages**, these values are not affected by the SOV feature.

Configuring scaled operational values

You can configure the alternate PT and CT values in the Vista component of ION Enterprise.

1. Open your meter in Vista.
2. Select the **Power Quality** tab and click the **Setup** icon to open the **Power Quality Setup** screen.

The Power Quality Setup screen contains fields where you can enter the alternate scaling register values, along with an indicator showing whether the SOV feature is enabled or disabled.



NOTE

The alternate scaling registers are set to 1 by default.

3. Enter the alternate PT and CT values to provide the desired scaling.

When the SOV feature is enabled and the alternate PT and CT values are configured (no longer equal to 1), the Vista screens indicate if the data values displayed are scaled operational values or not.

Chapter 7 Communications

This chapter includes general instructions for connecting and configuring all the communication ports on your meter.

For specific installation steps and meter specifications, consult your *ION8650 Installation Guide*.



NOTE

If you cannot communicate as expected with an ION8650C, ensure that you have enabled the communications port that you are using and that you have power cycled the meter. See “ION8650C communications options” on page 76 for more information.

In this chapter

- ◆ **Communications overview** 74
- ◆ **Communications options** 75
 - ION8650C communications options 76
- ◆ **Serial connections** 79
 - RS-232 connections 79
 - RS-485 connections 81
 - Configuring the optical port 84
- ◆ **Configuring Ethernet connections** 86
 - Configuring EtherGate connections 87
 - Using FTP 89
- ◆ **Internal modem connections** 91

Communications overview

The following illustration shows the connections to the communications card.

Back view of ION8650

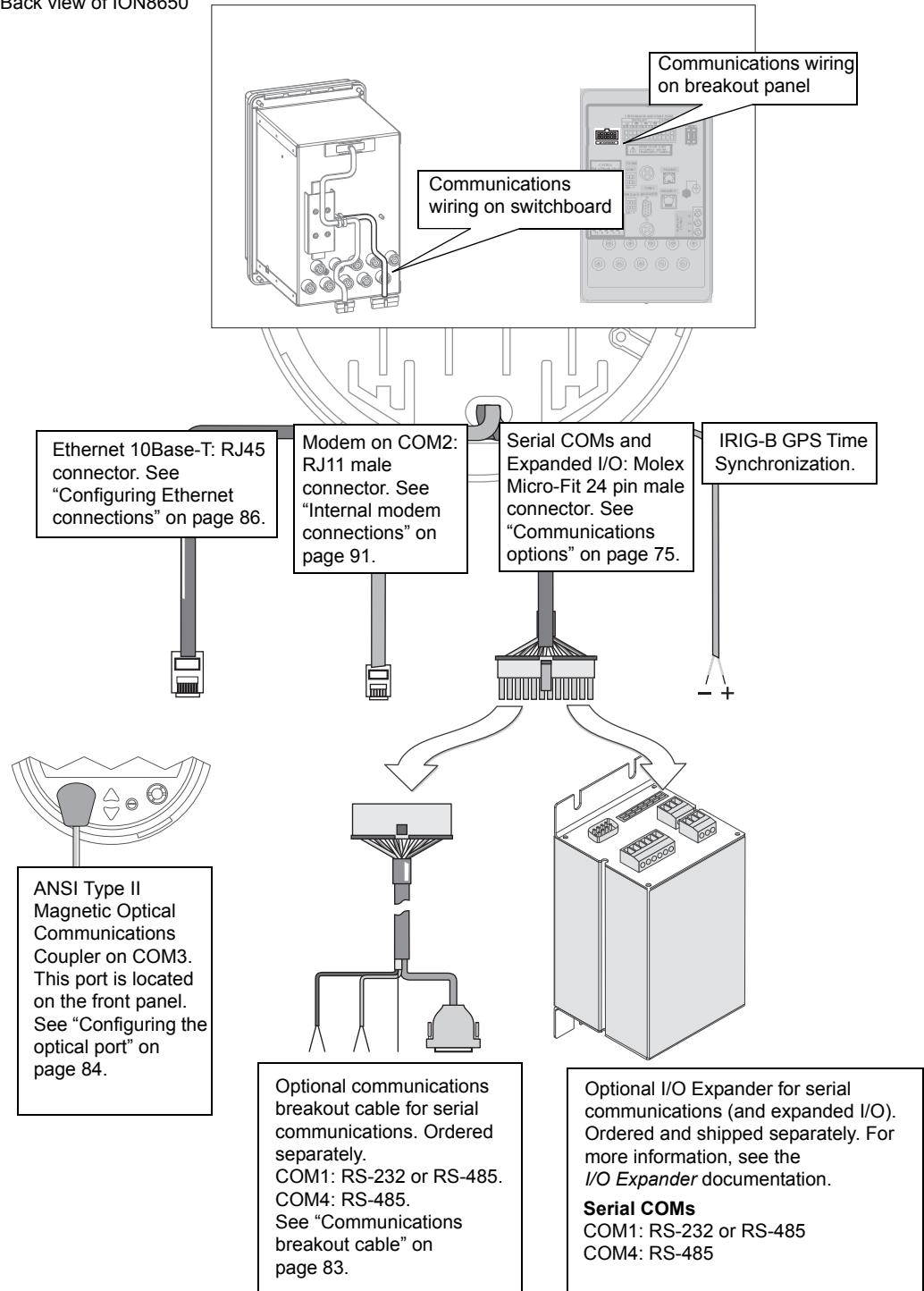

Communications options

ION8650 meters have numerous communication possibilities depending on your ordering options and, in the case of the ION8650C, the enabled communications ports. Not all models have exactly the same communications options available. Contact your Schneider Electric sales representative for the latest ordering options and documentation. You can use all communications ports simultaneously on the ION8650A and ION8650B; you can use the front optical port plus two other ordered communications ports simultaneously on the ION8650C.

Socket and switchboard meters communication options

Port	Available options	Notes
COM1	RS-232 / RS-485	User selectable RS-232 or RS-485
COM2	Internal Modem RJ11	Maximum 57.6 kbps baud rate modem
COM3	Optical Port	ANSI Type II optical port located at front of meter
COM4	RS-485	
Network	Ethernet RJ45 (10Base-T)	
IRIG-B	Captured wire connector	Format is unmodulated IRIG-B time code

Optional switchboard breakout panel communication options

See the *ION8650 switchboard installation* guide for wiring instructions..

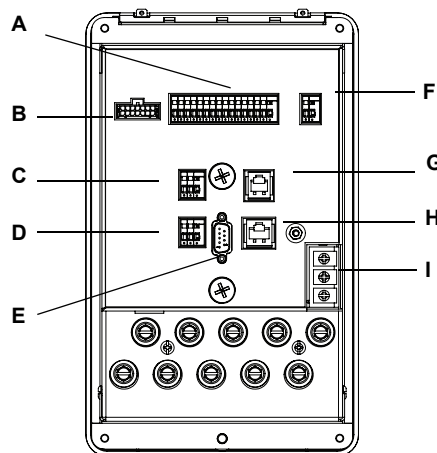

Connector type	
A	I/O Expander (option)
B	Onboard I/O (option)
C	COM1 RS-485
D	COM4 RS-485
E	COM1 RS-232
F	IRIG-B
G	Modem (option)
H	Ethernet (option)
I	Auxiliary power (option)



NOTE

The communications ports on an I/O Expander are not enabled when connected to a breakout panel. Use the RS-485 and RS-232 provided on the breakout panel.

Communications accessories

The following accessories are currently available as separate products:

I/O Expander

The I/O Expander connects with the male Molex connector on the meter to provide I/O capabilities as well as access to standard serial communications ports. Refer to the *I/O Expander Installation Guide* for details about this device.

Communications breakout cable

The communications breakout cable connects with the male Molex connector on the meter. This is a pre-made cable that provides access to the standard serial communications ports on the meter.

Molex extension cables

Molex extension cables can be ordered in both 5 and 15 feet (1.5 or 4.5 meter) lengths.

Optical probe

The optical probe attaches to the optical port on the front of the meter and allows on-site communications (for example, with a laptop computer).

ION8650C communications options

The ION8650C supports concurrent communications on the optical port (COM3) and a maximum of two other communications ports for a total of three simultaneous communications connections. If your ION8650C has three communications ports enabled, you must disable one of the active communications ports before you can enable another one in its place. For example, if you have an ION8650C with optional Ethernet enabled, you must disable the Ethernet port in order to communicate over both serial ports (COM1 and COM4).

The default settings vary depending on your order option. See your meter's *Installation guide* for details.



NOTE

Switching the active communications ports requires a meter reboot before the changes can take effect.

Enabling and disabling ION8650C communications ports using the front panel

1. Press the **ALT/ENTER** button to enter the SETUP menu.
1. Use the arrow buttons to scroll down the menu and select **ENABLED COM PORTS**, then press **ALT/ENTER**. Select **CONTINUE** and press **ALT/ENTER** when prompted.
2. Select the active communications port you want to disable (for example, Ethernet) and press **ALT/ENTER**. Select **DISABLED** and press **ALT/ENTER**. If prompted, enter the meter password to confirm the change.

3. Select the communications port you want to enable (for example, COM1) and press **ALT/ENTER**. Select **ENABLED** and press **ALT/ENTER**. Confirm the change if prompted.

⚠ WARNING

HAZARD OF UNINTENDED OPERATION

- Do not use the meter for critical control or protection applications where human or equipment safety relies on the operation of the control circuit.
- Be aware that an unexpected change of state of the digital outputs may result when the supply power to the meter is interrupted or after a meter firmware or template upgrade.

Failure to follow these instructions can result in death, serious injury or equipment damage.

4. Select **REBOOT** and press **ALT/ENTER**. Enter the meter password and confirm the change if prompted. This power cycles the meter and applies the change.



NOTE

Select **UNDO & RETURN** to exit the **ENABLED COM PORTS** setup menu without making any changes. Your meter will not reboot.

Enabling and disabling ION8650C communications ports using ION Setup



NOTE

You must manually power cycle the meter to have the changes take effect.

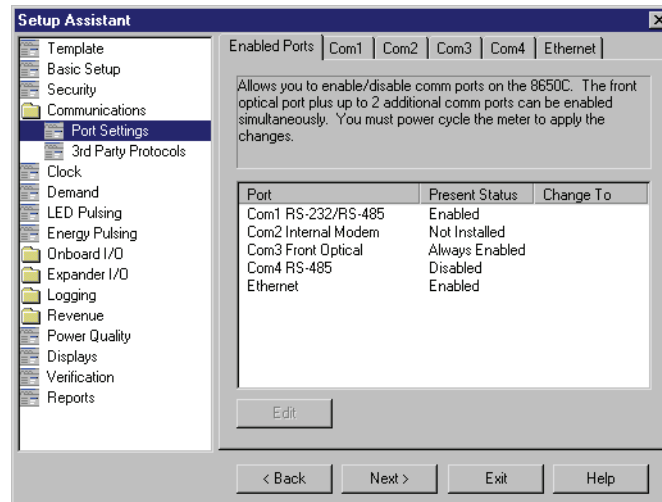

1. Select **Communications > Port Settings** and click the **Enabled Ports** tab.
2. Select an available port to enable or disable.
 - ◆ You can only enable or disable communications ports that were ordered with the meter. Ports that were not ordered appear in the list as **Not Installed** (in the graphic above, COM2 was not ordered).

- ◆ The front optical port is always enabled and cannot be disabled.

Click **Edit**. Enter the meter password, if prompted. The **Set Enabled Ports** dialog box appears.

3. Select a checkbox to enable a listed port or clear a checkbox to disable a listed port. You can enable a maximum of two of the ports listed in the dialog box.
4. Click **OK** to return to the Setup Assistant. Changes will take effect the next time the meter is power cycled, either manually or in a power outage.

WARNING

HAZARD OF UNINTENDED OPERATION

- Do not use the meter for critical control or protection applications where human or equipment safety relies on the operation of the control circuit.
- Be aware that an unexpected change of state of the digital outputs may result when the supply power to the meter is interrupted or after a meter firmware or template upgrade.

Failure to follow these instructions can result in death, serious injury or equipment damage.

Serial connections

The ION8650 provides RS-232 and RS-485 serial communications connections, located on the back of the meter, as well as an optical port, located on the front of the meter.

Refer to the *ION8650 Installation Guide* for information on determining the serial port options available on your meter.

If the meter's COM1 port is set to RS-232, you can connect this port to a remote modem, which in turn is connected to a computer. You must use a null-modem RS-232 cable to connect the meter to an external modem. One end of the cable must be equipped with a Micro-Fit 3.0 Molex female connector for mating with the Molex male connector on the meter.

You can connect numerous meters' COM1 ports by selecting RS-485 and using an RS-232 to RS-485 converter to create a serial network.



NOTE

You cannot use both RS-232 and RS-485 ports on the meter's COM1 simultaneously.

You can configure your local and remote modems with ION Enterprise or ION Setup. You can also use ION Setup or ION Enterprise to schedule regular connection times to collect meter data.

Extension cables with Molex connectors are available for your meter. Pin assignments for the Molex connector are provided in the *ION8650 Installation Guide* that ships with the meter (also available at www.schneider-electric.com).



NOTE

The total number of possible serial connections is limited by the number of physical serial ports on the meter. The meter has two physical serial ports (not counting the front optical port).

RS-232 connections

Refer to the *ION8650 Installation Guide* for the meter's RS-232 specifications and specific wiring instructions.

Because of the wiring configuration between pins 2 and 3, the meter is considered a DTE (Data Terminal Equipment) device in all RS-232 connections. Please see "Meter connections to single devices" on page 80.

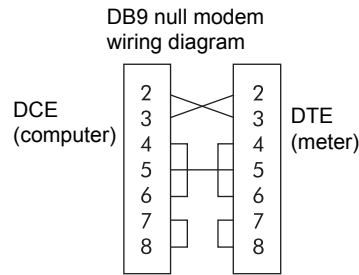

Communications settings for the RS-232 port are accessible through the front panel SETUP menu, ION Enterprise or ION Setup.

Meter connections to single devices

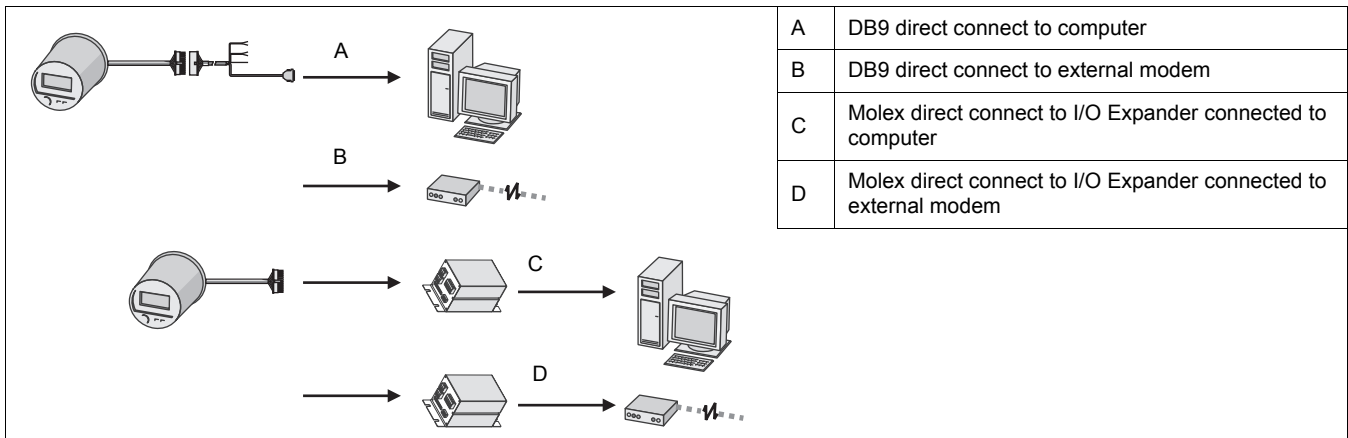

Meter connections to a serial loop

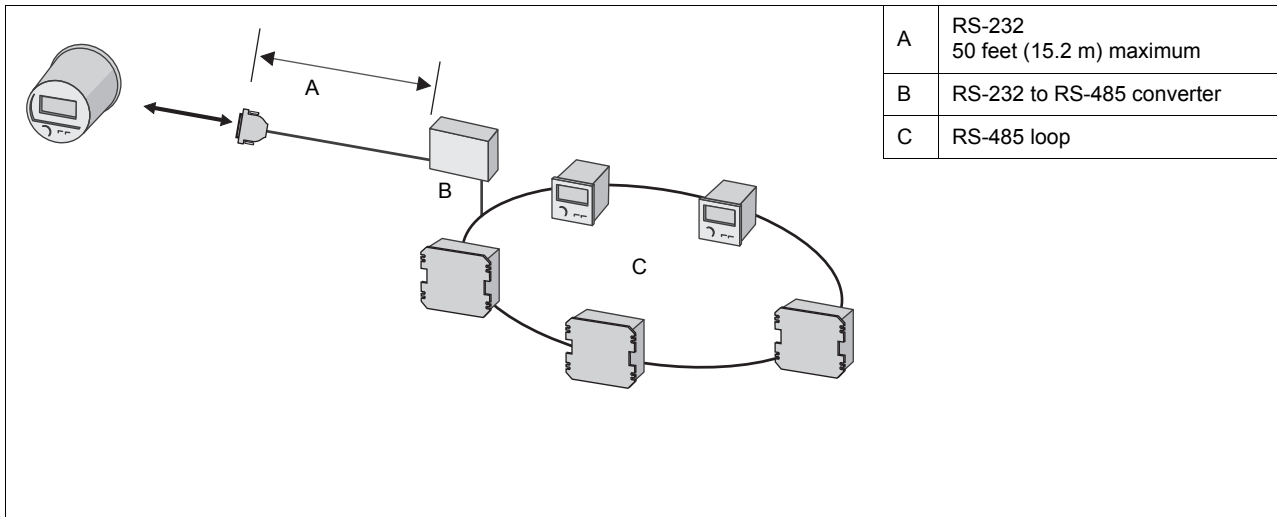

RS-485 connections

Refer to the *ION8650 Installation Guide* for RS-485 specifications and wiring instructions.

The breakout cable's twisted pair provide connections for both of the meter's RS-485 serial communications ports. The first set is for COM1 RS-485 connections. The second set is for COM4 RS-485 communications.

Up to 32 devices can be connected on a single RS-485 bus. Use a good quality shielded twisted pair cable for each RS-485 bus, AWG 22 (0.33 mm²) or larger. The overall length of the RS-485 cable connecting all devices cannot exceed 4000 feet (1219 m). The RS-485 bus can be configured in straight-line or loop topologies.

Straight-line topology

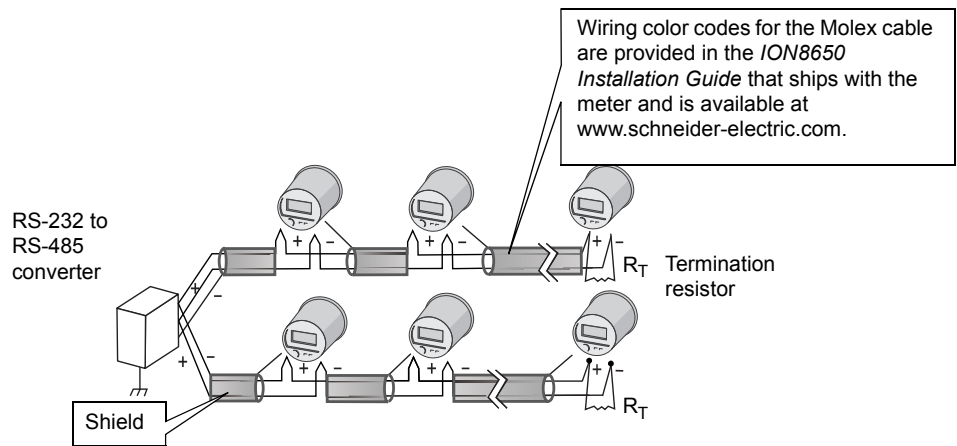

Loop topology

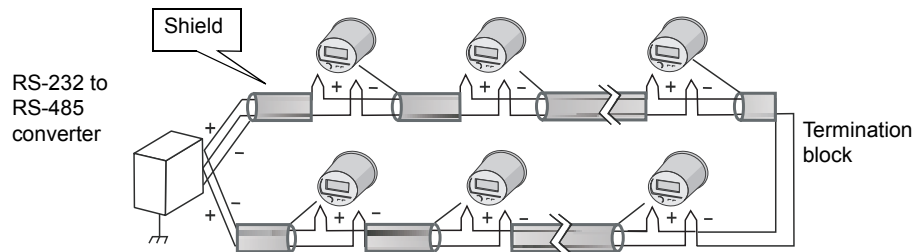

General bus wiring considerations

Devices connected on the bus, including the meter, converter(s) and other instrumentation, must be wired as follows:

- ◆ Connect the shield of each segment of the cable to ground at *one end only*.
- ◆ Isolate cables as much as possible from sources of electrical noise.
- ◆ Use an intermediate terminal strip to connect each device to the bus. This allows for easy removal of a device for servicing if necessary.

- ◆ Install a ¼ Watt termination resistor (R_t) between the (+) and (-) terminals of the device at each end point of a straight-line bus. The resistor should match the nominal impedance of the RS-485 cable (typically 120 ohms – consult the manufacturer’s documentation for the cable’s impedance value).

RS-485 connection methods to avoid

Avoid any device connection that causes a branch in the main RS-485 bus. This includes *star* and *tee* (*T*) methods. These wiring methods can cause signal reflections that can lead to interference. At any connection point on the RS-485 bus, no more than two cables should be connected. This includes connection points on instruments, converters, and terminal strips. Following this guideline ensures that both star and tee connections are avoided.

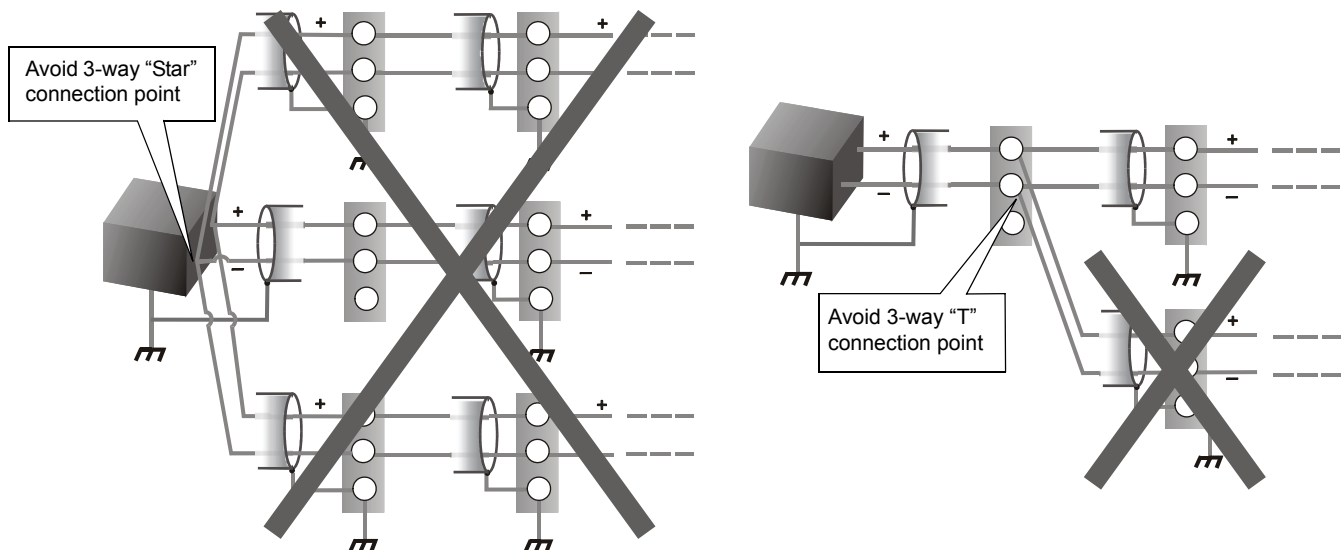

RS-485 biasing

The RS-485 +/- wires are floating (ungrounded) so there can be voltage signals on the wires even when there is no device communicating on the bus. The amount of floating voltage depends on many factors, such as capacitive effects in the RS-485 bus and noise in nearby systems. If the floating voltage is high enough, it can be incorrectly interpreted as an RS-485 signal and cause your meter to stop communicating. The meter has an RS-485 biasing option to prevent the RS-485 bus from floating when devices are not sending data.

Setting RS-485 biasing using the front panel

1. Press and hold the **ALT/ENTER** button for a few seconds. The SETUP menu appears.
2. Use the navigation buttons to highlight the RS-485 COM port that you want to configure (COM1 or COM4) and press **ALT/ENTER** to select.
3. Use the navigation buttons to highlight RS-485 BIAS and press **ALT/ENTER** to select.
4. Select either ON (RS-485 biasing applied) or OFF (RS-485 biasing not applied).

Setting RS-485 biasing using ION Setup

In ION Setup:

1. Open the Setup Assistant for your meter. See the ION Setup Help for instructions
2. Select **Communications > Port Settings**.
3. Click the **COM1** or **COM4** tab. Select RS-485 Bias and click **Edit**.
4. Select ON to apply RS-485 biasing or OFF to not apply RS-485 biasing.
5. Click **OK**.

Communications breakout cable

Refer to the *ION8650 Installation Guide* for the DB9 serial pin assignments for the optional breakout cable female DB9 connector. A communications breakout cable facilitates communications connections by connecting to the Molex male connector on your meter. The cable splits to a standard DB9 female connector and two RS-485 shielded, twisted pairs. Cable length is 152 cm (5 feet).

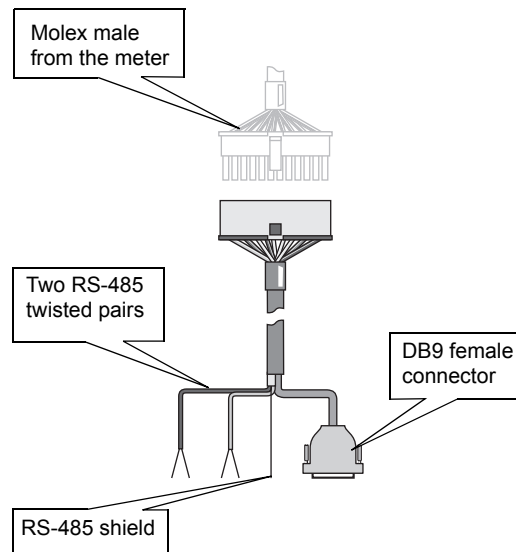

Configuring RS-485

Using the front panel

1. Press and hold the **ALT/ENTER** button for a few seconds. The SETUP menu appears.
2. Use the navigation buttons to highlight the RS-485 COM port that you want to configure (COM1 or COM4) and press **ALT/ENTER** to select.
3. Configure the settings (for example, Protocol, Baud Rate and Unit ID) to match your communication system.

Using ION Setup

In ION Setup:

1. Open the Setup Assistant for your meter. See the ION Setup Help for instructions.
2. Select **Communications > Port Settings**.
3. Click the **COM1** or **COM4** tab and configure the settings (for example, Protocol, Baud Rate, and Unit ID) to match your communications system.

Configuring the optical port

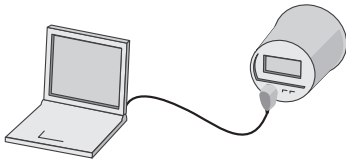

Refer to the *ION8650 Installation Guide* for optical port specifications.

The optical port available on ION8650 meters is compatible with standard magnetic optical communications couplers, or optical probes (ANSI Type II). Optical probes are available both from Schneider Electric and other suppliers as a separate product; contact Schneider Electric for a list of suppliers. The original equipment manufacturer's warranty applies. See the *Optical Magnetic Couplers* technical note for more detailed information.

Optical probes can communicate real-time measurements via the ION, RTU, DNP 3.0, Factory, or GPS protocols. You can configure the optical port communications settings with the front panel, ION Enterprise or ION Setup.

Using the front panel

1. Press and hold the **ALT/ENTER** button for a few seconds. The SETUP menu appears.
2. Use the up or down arrow buttons to select COM3 SETUP.
3. Press the **ALT/ENTER** button to access COM3 SETUP parameters.
4. Configure the settings (for example, Baud Rate, Unit ID, and Protocol) to match your communications system.

Using ION Setup

In ION Setup:

1. Open the Setup Assistant for your meter. See the ION Setup Help for instructions.
2. Select **Communications > Port Settings**.
3. Click the **COM3** tab and configure the settings (for example, Baud Rate, Unit ID, and Protocol) to match your communications system.

To enable communications from the optical port, you must configure the COM3 communications. The Protocol, Baud Rate and Unit ID settings must properly match your system. When creating a site, ensure RTS Control setting is disabled for the COM3 serial site.

Using ION Enterprise

1. Open Management Console and add a Direct Site.
2. Set the Serial Port to COM3 and ensure that the settings properly match your system. Ensure that RtsCts is disabled for the optical port site in Management Console. Refer to the Management Console section of the online ION Enterprise help for details.

Configuring Ethernet connections

This section only applies if your meter has the Ethernet option. Refer to the *ION8650 Installation Guide* for Ethernet port specifications and information on determining the options available on your meter.

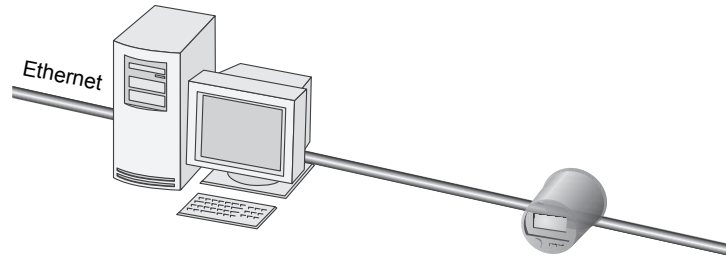

Ethernet connections are made via the RJ45 modular jack on the rear of the unit. Use high quality Category 3, 4 or 5 UTP cable (RJ45 female to RJ45 male) if you require an extension. The optional Ethernet port is capable of data rates up to 10 Mbps and supports TCP/IP, FTP, ION, Telnet, and Modbus/TCP protocols. The meter supports a maximum of eight simultaneous Ethernet connections with additional dedicated connections for Modbus master over TCP/IP and IEC 61850.



NOTE

Some features, such as IEC 61850 and COMTRADE, require that your meter has an Ethernet connection.

Ethernet connections for the ION8650

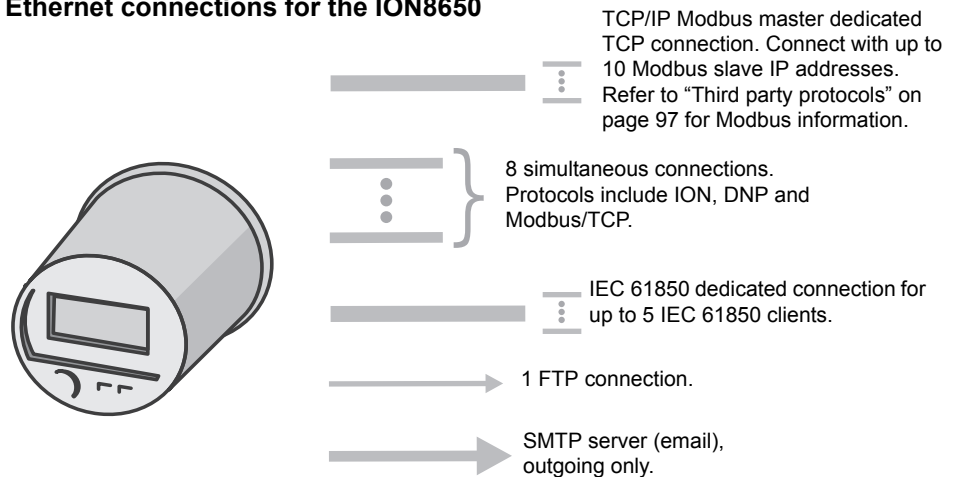

You can configure Ethernet communications using the front panel, ION Enterprise or ION Setup. In each case, you must configure the *IP Address*, *Subnet Mask*, *Gateway*, *SMTP Server* and *SMTP Connection Timeout* to properly match your system.



NOTE

The MAC address of your meter cannot be changed, and is provided for information only.

Using the front panel

1. Press and hold the **ALT/ENTER** button for a few seconds. The SETUP menu appears.
2. Use the up or down arrow buttons to select NETWORK SETUP and press **ALT/ENTER**.
3. Configure the Ethernet Communications settings (for example, IP Address, Subnet Mask, Gateway and SMTP Server) to match your communications system.

Using ION Setup

In ION Setup:

1. Open the Setup Assistant for your meter. See the ION Setup Help for instructions.
2. Select **Communications > Port Settings** and click the **Ethernet** tab.
3. Select a setting and then click **Edit**. Configure the settings (for example, IP Address, Subnet Mask, Gateway, SMTP Server and SMTP Connection Timeout) to match your communications system.

Using ION Enterprise

After you wire your meter to the Ethernet network and perform basic setup, add the meter to your ION Enterprise network using Management Console.

To enable communications through the Ethernet port, you must configure the Ethernet Communications module. Start Designer and configure the IP Address, Subnet Mask, Gateway, SMTP Server and SMTP Connection Timeout registers to match your system.

Adding an Ethernet device to your ION Enterprise network

In Management Console, the Ethernet Device Options screen appears when you add an Ethernet device (meter). Use this screen to describe your meter's Ethernet address and other communications information. Be sure to include:

- ◆ the server computer that communicates with the Ethernet device.
- ◆ the Ethernet device TCP/IP address.

Configuring EtherGate connections

The meter can function as an Ethernet gateway (EtherGate). EtherGate is a powerful communications tool that lets you communicate *through* a gateway meter to a serial network connected to the meter. When a meter installed on the Ethernet network has EtherGate enabled, a master device (such as a workstation running ION Enterprise) can communicate *through* the gateway meter to a serial network of devices wired to the gateway meter's COM port. The transfer of data between protocols is handled automatically. EtherGate is available on serial ports COM1 and COM4 in place of the ION, Modbus Master, Modbus RTU, or DNP 3.00

protocols. With EtherGate enabled, the meter permits the direct transfer of data from up to 62 devices (31 devices per COM port).

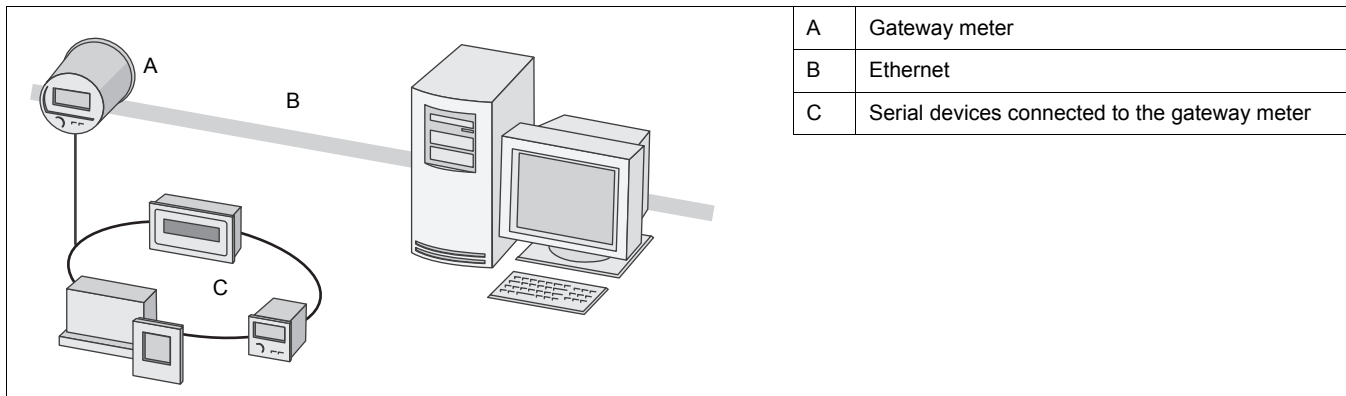

Install the serial devices, configure them and connect them to your Ethernet-connected gateway meter. Ensure that each serial device is configured with the same baud rate and has a unique Unit ID. Then use the meter's front panel, ION Enterprise or ION Setup to change the COM1 or COM4 *Protocol* setting to **EtherGate**. You must then create an EtherGate site in ION Enterprise or ION Setup, and add the serial devices to the EtherGate site. See *The ION meter as an Ethernet gateway* technical note for more information on setting up an Ethernet gateway.

Using the front panel to set the EtherGate protocol

1. Press and hold the **ALT/ENTER** button for a few seconds. The **SETUP** menu appears.
2. Use the up or down arrow buttons to select the COM port that you want to configure (COM1 or COM4) and press **ALT/ENTER**.
3. Scroll to **PROTOCOL** and press **ALT/ENTER**. Change the port's **PROTOCOL** setting to **ETHERGATE**.
4. Press **ALT/ENTER** to set the protocol.

Using ION Setup to create an EtherGate site

Follow the instructions below to communicate to the devices on the RS-485 loop with ION Setup.

In ION Setup:

1. Right-click on your workstation icon and select **Insert Item**. The **New Network Item** dialog box appears.
2. Select **Site** and click **OK**. The **New Site** dialog box appears.
3. Click the **General** tab.
4. Configure the site as follows:
 - ◆ Type a site name.

- ◆ Select Ethernet from the Comm Link options.
- ◆ Select the Gateway check box.
- ◆ Type the meter's IP address and select a port in the Gateway Info fields. For the port, select either **7801** for COM1 or **7802** for COM4.

Click **OK**.

5. Right-click on your newly created site and select **Insert Item**. The **New Network Item** dialog box appears.
6. Select **Meter** and click **OK**. The **New Device** dialog box appears.
7. Enter serial device information here and click **OK**. Your new device appears under your newly created site
8. Repeat steps 5 to 7 to enter each device on your serial network.



NOTE

Use a standard Ethernet connection in ION Setup to connect to and read data from your EtherGate meter.

Using ION Enterprise to create an EtherGate site

Follow the instructions below to communicate to the devices on the RS-485 loop with ION Enterprise.

In Management Console:

1. Create an Ethernet gateway site.
2. Configure your Ethernet gateway site with the IP address of the gateway meter. Select the IP Port that matches the gateway meter's COM port that is connected to the RS-485 loop (select **7801** for COM1 or **7802** for COM4).
3. Add each of the devices on the RS-485 loop to the Ethernet Gateway site (you do not need to add the gateway meter as a device).



NOTE

Use a standard Ethernet connection in ION Enterprise to connect to and read data from your EtherGate meter.

Using FTP

The meter can function as an FTP server, supporting IEC 61850 protocols and COMTRADE formatted waveform files. The FTP timeout period is 90 seconds on a control port. Only one simultaneous FTP transfer connection is permitted. To connect to your meter, ensure that your FTP software is configured to only use a single FTP connection. The recommended FTP software is Windows Explorer or WinSCP running on a Windows-based machine.

**NOTE**

To connect to your meter using Windows Explorer, you must include the login and password in the FTP connection string. For example, with standard meter security (no user configured) and the a front panel password of **2**, to connect to a meter with an IP address of **123.45.6.78**, the Windows Explorer connection string would be **ftp://0:2@123.45.6.78**.

The meter communicates via FTP on the following ports:

Port	Description
21	Incoming commands connections
20	Active data connections
3000-3020	Passive data connections

File names are limited to ASCII characters that do not contain a blank space or /, \, ", *, ?, <, >, and have a maximum length of 64 characters.

For more information about using FTP for IEC 61850 or COMTRADE, refer to the *IEC 61850 protocol and ION Technology* protocol document or the *COMTRADE and ION Technology* technical note.

Internal modem connections

This section only applies if your meter has the internal modem option. Refer to the *ION8650 Installation Guide* for internal modem specifications and information on determining the options available on your meter

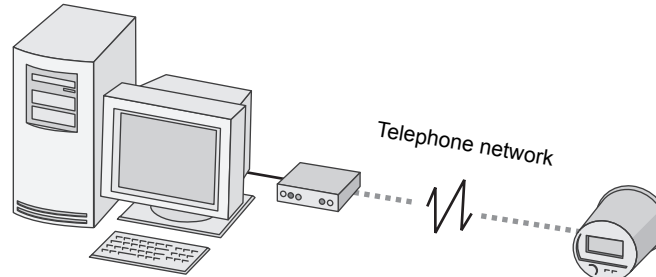

The internal modem is accessed through COM2, supports all standard modem protocols at transmission rates from 300 bps to 57600 bps (300 bps is only recommended for paging applications) and can be shared by up to 31 devices on an RS-485 chain. It is available with a standard six-pin RJ-11 phone plug. If you have multiple meters linked on an RS-485 loop, only the first meter requires an internal modem. This setup is referred to as a ModemGate (see “Configuring ModemGate connections” on page 93). You can configure the settings of the internal modem with the front panel, ION Enterprise or ION Setup.

To enable communications through the meter’s internal modem, configure the COM2 communications *Baud Rate*, *Unit ID*, *Protocol*, and *ModemInit* setup registers as required for your system. See “ModemInit setup register” on page 91 for more information on this register.



NOTE

When the meter is equipped with the Alert module, the modem can initiate calls. Paging is supported through numeric paging and the TAP1 protocol. See the *ION Enterprise* online help for details on managing modem connections, setting up periodic dial-out and configuring remote site event notification.

ModemInit setup register

The *ModemInit* setup register defines the initialization string for the internal modem with a maximum of 47 characters. Edit the *ModemInit* register and enter the desired initialization string. The string is sent to the modem as soon as you download the COM2 module. Note that the string is also sent to the modem whenever the meter is powered up or the baud rate in the COM2 Communications module is changed.



NOTE

Changing the *ModemInit* or *Baud Rate* setup registers while the internal modem is online causes the modem to disconnect from the phone line.

Modem initialization strings

Refer to the *Modem AT Commands* technical note for a complete list of AT commands for meter modems.



NOTE

The *Modem AT Commands* technical note also contains instructions on how you can determine your meter's modem type based on the meter's serial number.

Adjusting the modem initialization string for CTR-21 compliant modems

The table below shows the strings to add to the end of your modem configuration string setup register for each of three possible scenarios.

Behavior	Add to modem initialization string
Does not answer (modem does not detect ring tone)	*NC70
Does not dial (modem does not detect dial tone)	In order of preference: *NC70, *NC70X0, *NC8 (Italy only)
Does not detect busy signal	*NC70

If your *local* modem (not the internal modem) is not already set up, configure it with the Remote Modem Setup utility in ION Enterprise according to the instructions in the online help. After the meter is installed and the internal modem is connected to the telephone network, the COM2 module can be configured using the meter's front panel, ION Enterprise or ION Setup. For information on how to connect the internal modem to the telephone network, refer to your *ION8650 Installation Guide*.

Configuring COM2 through the front panel

1. Press and hold the **ALT/ENTER** button for a few seconds. The SETUP menu appears.
2. Use the up or down arrow buttons to select COM2 SETUP and press **ALT/ENTER**.
3. Configure the COM2 settings (for example, Baud Rate, Unit ID, and Protocol) to match your communications system.

Configuring the meter and modem site using ION Setup

In ION Setup:

1. Open the Setup Assistant for your meter. See the ION Setup Help for instructions.
2. Select **Communications > Port Settings** and click the **COM2** tab.
3. Select the setting that you want to configure and click **Edit**.
4. Configure the COM2 settings (for example, Baud Rate, Unit ID, and Protocol) to match your communications system.

Configuring the COM2 module using Designer

Before you can configure the COM2 module in Designer, you must add the meter (with the internal modem) and a modem site to your ION Enterprise network.

Adding a meter and a modem site to your ION Enterprise network

In Management Console, add the meter with the internal modem and a modem site to your ION Enterprise network. Describe how your remote modem is wired and other communications information on the options screens.

Either before or after adding the modem site, you must add a dialout modem to the server computer. The server computer dialout modem communicates to the modem at the modem site.

On the Modem Site Options screen, ensure that:

- ◆ you select the server computer that you want to communicate with the remote modem and that the server computer dialout modem is configured.
- ◆ you enter the remote modem telephone number.
- ◆ you set the baud rate of the modem site to the baud rate of the COM2 port to avoid communications errors.

See the *ION Enterprise* online help for more information.

Configuring the COM2 Communications module in Designer

Start Designer and configure the COM2 Communications module *Baud Rate*, *Unit ID*, and *Protocol* setup registers to match your communications system. Configure the initialization string for the internal modem using the *ModemInit* register. Refer to “ModemInit setup register” on page 91.

Configuring ModemGate connections

ModemGate is a powerful feature that creates a communications connection between the telephone network and an RS-485 serial network of devices. When you specify the protocol for a meter’s COM port as MODEMGATE, all data received by the meter’s internal modem is automatically transferred to the serial network. ModemGate is available on either the COM1 or COM4 port; you cannot use the feature on both ports simultaneously. The meter must have the COM2 modem option to function as a modem gateway.

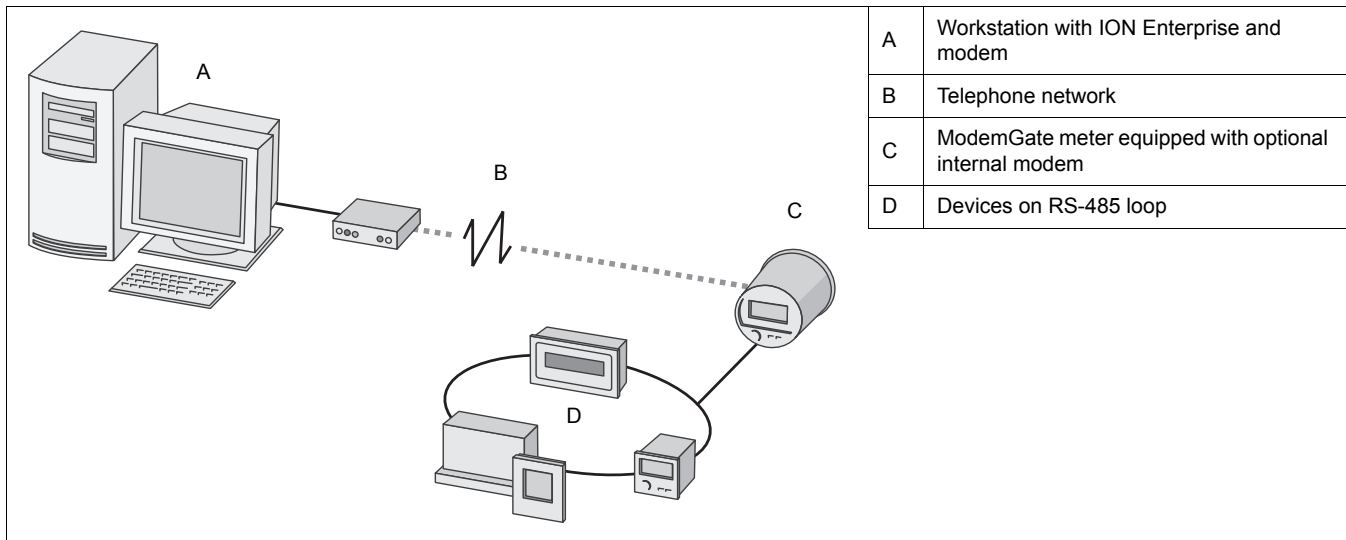

NOTE

The baud rate used between connected modems is independent of the internal baud rate used for communication between the meter and its modem.

Wire a serial connection between one or more meters and the meter COM port hosting the ModemGate (COM1 or COM4). You can make ModemGate connections through an RS-232 cable to a single device or through an RS-485 shielded twisted pair cable to multiple devices. ModemGate connections do not connect a workstation running ION Enterprise (or other master device) to the gateway meter's COM1 or COM4 port, but rather to the gateway meter's internal modem port (COM2); the meter then transfers the data to the serial devices connected to COM1 or COM4.

Configuring the meter for ModemGate

1. Install the meter and connect the internal modem.
2. Use the front panel, ION Enterprise or ION Setup to set up the internal modem and the serial communications port (COM1 or COM4) that is the ModemGate. You can enable ModemGate on either COM1 or COM4, not both simultaneously.
3. Set the internal modem COM2 *Baud Rate*, *Unit ID* and *Protocol*. The baud rate must be the same as the port hosting the gateway and all the devices connected to the gateway.
4. Set the protocol of the port connected to the RS-485 loop to MODEMGATE (either COM1 or COM4). For each device on the RS-485 loop, you must also:
 - ◆ Set the baud rate to the same value as the modem baud rate (COM2).
 - ◆ Configure each device, including the gateway meter, with a unique Unit ID.

Configuring devices connected to the ModemGate meter

1. Use ION Enterprise, ION Setup or the front panel to change and configure settings. Ensure each device connected to the meter has the same baud rate as the meter ModemGate port (either COM1 or COM4).
2. Ensure each device connected on the RS-485 network (including the meter modem) has a unique Unit ID. Record the serial baud rate of the modem site and the Unit IDs for every device in order to add the ModemGate and its meters to your network.



NOTE

Ensure RS-485 is selected for connections to multiple devices along the same bus.

Using ION Setup to create a ModemGate site

In ION Setup:

1. Right-click on your workstation icon and select **Insert Item**. The **New Network Item** dialog box appears.
2. Select **Site** and click **OK**. The **New Site** dialog box appears.
3. Click the **General** tab.
4. Configure the site as follows:
 - ◆ Type a site name.
 - ◆ Select Modem from the Comm Link options.
 - ◆ Click **Modem configuration** to access the Modem configuration wizard, which configures your local and remote modems.
 - ◆ Enter the phone number of the modem you are connecting to in the Phone Number field.

Click **OK**.

5. Right-click on your newly created site and select **Insert Item**. The **New Network Item** dialog box appears.
6. Select **Meter** and click **OK**. The **New Device** dialog box appears.
7. Enter serial device information and click **OK**. Your new device appears under your newly created site
8. Repeat steps 5 to 7 to enter each device on your serial network.

Using ION Enterprise to create a ModemGate site

To communicate to the devices on the RS-485 loop using ION Enterprise:

1. Start Management Console and create a Modem Site.
2. Configure your modem site by typing in the appropriate fields or using the dropdown menus. Include the meter's internal modem telephone number and ensure that the server computer's dialout modem is configured. Refer to the online *ION Enterprise Help* for information on adding a dialout modem.

Adding ModemGate meters to the ION Enterprise network

1. Start Management Console and click **Devices**. Right-click in the Devices display window and select **New > Serial Device on Direct Site**.
2. Enter the information by typing in the appropriate fields or using the dropdown menus, remembering that:
 - ◆ Unit ID: The value in the UNIT ID field identifies the meter on the RS-485 loop.
 - ◆ Site: The ModemGate site that you created.

Chapter 8 Third party protocols

This chapter explains how Modbus, DNP 3.0 and IEC 61850 protocols are implemented on the meter.

It also contains brief instructions for configuring your meter to work with MV-90 systems.

In this chapter

- ◆ **Overview** **98**
 - Communications protocol configuration 98
- ◆ **The meter as Modbus slave** **99**
 - Using the Modbus RTU protocol 99
 - Configuring the meter as a Modbus slave 100
 - Modbus Slave modules 101
 - Using the Modbus/TCP protocol 101
- ◆ **The meter as Modbus master** **103**
 - Configuring the meter as a Modbus master 103
- ◆ **Using the DNP 3.0 protocol** **108**
 - Configuring DNP 3.0 108
- ◆ **Using the IEC 61850 protocol** **110**
 - The default IEC 61850 configuration 110
 - Configuring IEC 61850 110
- ◆ **Configuring MV-90** **115**

Overview

The meter supports DNP 3.0, Modbus RTU and Modbus/TCP, and IEC 61850 protocols.

Most Modbus, IEC 61850 and DNP modules that send meter data using these protocols are factory configured and only require basic configuration, such as communications setup.

- ◆ Your meter is preconfigured to **send** Modbus data (acting as Modbus slave). It is not ready to **receive** data as a Modbus master until you set up the necessary framework.
- ◆ Your meter is preconfigured to **send** DNP 3.0 data to a DNP master.
- ◆ You must use an IEC 61850 configuration tool and ICD file to configure the IEC 61850 aspects of your meter, with the exception of I/O and additional data values, which must be done through ION Setup.



NOTE

Changing the default third-party protocol frameworks (or creating new frameworks to enable receive functionality) is an advanced procedure that requires an understanding of the protocol and the meter's internal operation before you proceed. Refer to the descriptions in the *ION Reference* of the DNP, IEC 61850 and Modbus modules. Refer to the *Multipoint DNP 3.0 and ION Technology, DNP 3.0 Device Profile, IEC 61850 and ION Technology*, and *Modbus and ION Technology* documents for information on these protocols.

Communications protocol configuration

In order to use the pre-configured Modbus or DNP slave configuration, you must first assign the communications protocol that you want to use to the applicable port. By default, all communications ports are configured to use the ION protocol. Select the third-party protocol that you want from the list of available protocols for the communications port you are configuring. See “Communications” on page 73 for instructions. You do not have to assign a communications channel for IEC 61850 but your meter must have an Ethernet connection.



NOTE

Modbus RTU is available on each of the meter's communications ports, and multiple ports can communicate using Modbus simultaneously. Modbus TCP is available on the meter's optional Ethernet connection. Up to three ports can use the DNP 3.00 protocol at any one time.

The meter as Modbus slave

Your meter can act as a Modbus slave, using both the Modbus RTU and Modbus/TCP protocols.

The meter can act as a Modbus slave device, making any real-time data available through the Modbus protocol. Modbus master devices connected to the meter can read this data or write data to your meter's ION registers (for example, to make configuration changes).

Using the Modbus RTU protocol

The factory Modbus slave configuration

The meter makes data available to Modbus master devices using pre-configured Modbus Slave modules. These modules are linked to other modules in the meter that provide the energy, power and demand data. Once a communications channel is configured to use Modbus RTU protocol, the data is available to Modbus master devices.



NOTE

Connect to IP port 7701 for Modbus RTU communications over Ethernet. The Modbus unit ID of the meter over Ethernet has a default value of 100.

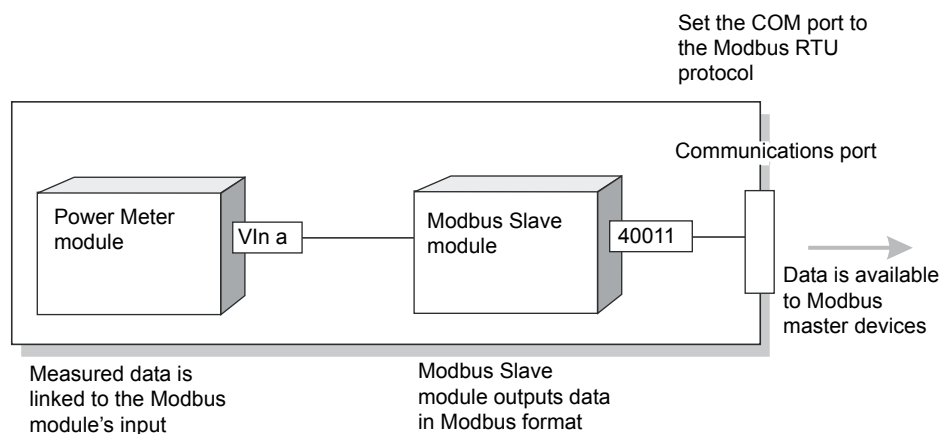

As the data available through the Modbus Slave modules is in a specific format, knowledge of the Modbus protocol and an understanding of the settings used in the meter are required to interpret the data provided.

Changing the Modbus configuration

If the factory Modbus configuration does not suit your needs, the existing Modbus Slave modules can be relinked to other parameters that you want to access through Modbus.

If your Modbus master device requires data in a format different than that provided by the factory Modbus configuration, you can edit the setup registers in the Modbus Slave modules. These setup registers specify the Modbus format, scaling and base address settings. Refer to the *ION Reference* for complete details on the Modbus Slave module.

Configuring the meter as a Modbus slave

You cannot configure Modbus through the meter's front panel; you can only assign the Modbus protocol to communication ports (see "Communications" on page 73 for details).

Use ION Enterprise or ION Setup to perform full Modbus configuration.

Using ION Setup

In ION Setup:

1. Open the Setup Assistant for your meter. See the ION Setup Help for instructions.
2. Select **Communications > 3rd Party Protocols**.
3. Click the **Modbus Slave** tab.
4. Select the map name (for example, Default) and click **Edit**. The Modbus map editor appears.

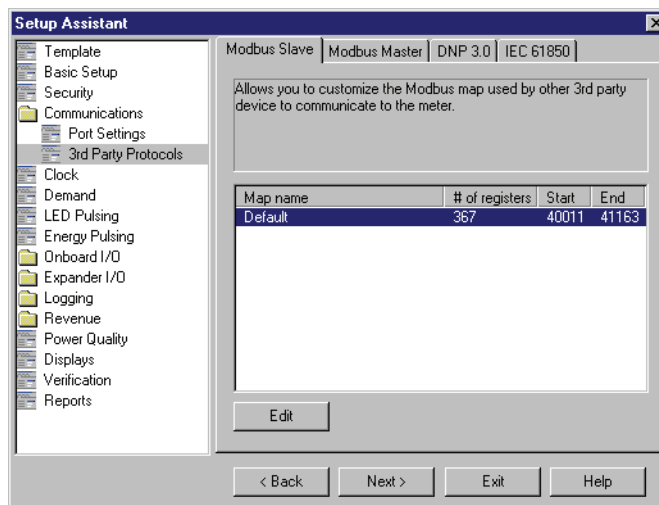

5. Edit, add, or delete the Modbus Slave module registers or the name of the Modbus map.

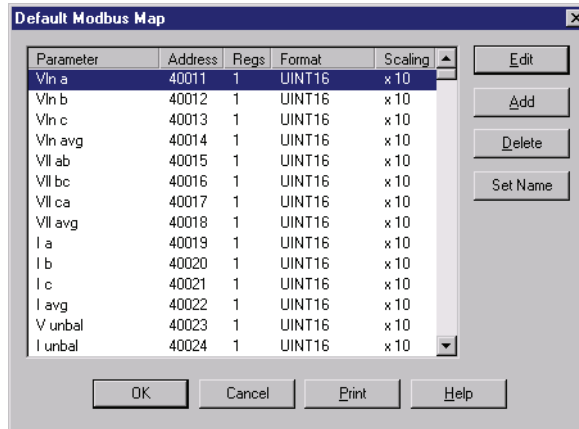

6. Click **OK**.

Modbus Slave modules

All ION8650 meters have nine Modbus Slave modules. Meters with EN51060 support (ION8650A and ION8650B) have 11 additional modules. For a detailed Modbus map, refer to the *Modbus Protocol and Register Map for ION Devices* document, available from www.schneider-electric.com.

Importing data using Modbus RTU

It is possible to bring data into the meter using Modbus. Various ION registers can be written to by Modbus master devices by correlating the Modbus register number with the address of the ION register you want to write to. When a Modbus register is written with a value, the corresponding ION register is written, provided the Modbus RTU protocol is active on the communications port that connects the Modbus master to the meter.

You can use the Modbus RTU protocol to write values into ION external numeric, pulse and Boolean registers, allowing you to enable, disable and reset meter functions. You can also use the Modbus protocol to change setup register values in various ION modules to configure the meter's operation.

To bring data into the meter with Modbus RTU, you must disable the meter's password security.

Using the Modbus/TCP protocol

Modbus/TCP is an open Modbus protocol variant (formerly called MBAP). It defines the packet structure and connection port (port 502) for the industry standard TCP/IP protocol. The structure of Modbus/TCP is very similar to the Modbus RTU packet except that it has an extra six-byte header and does not use the cyclic redundancy check (CRC). Modbus/TCP retains the Modbus RTU limit of 256 bytes per packet.

 **NOTE**

For Modbus RTU communications over Ethernet, connect to IP port 7701.

Modbus TCP communications

You can communicate to the meter using Modbus TCP. Your meter must have the optional Ethernet port. Configure the meter to connect using connection port **502** to use Modbus TCP communications protocols.

 **NOTE**

You cannot form an EtherGate connection to the Modbus TCP network.
The Modbus unit ID of the meter over Ethernet has a default value of 100.

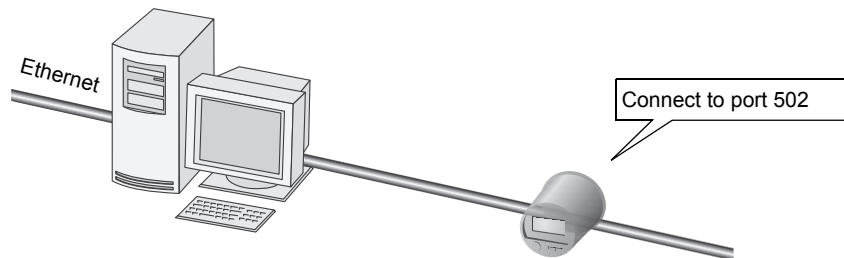

The meter as Modbus master

ION8650 meters can act as a Modbus master using the Modbus RTU and Modbus/TCP protocols:

- ◆ The meter can Modbus master using Modbus RTU over serial connections between the meter's COM1 or COM4 ports and the Modbus slave devices. It can Modbus master over both COM1 and COM4 simultaneously.
- ◆ Meters with an Ethernet connection can Modbus master over TCP/IP using up to ten available TCP connections. These TCP connections are dedicated to Modbus mastering, and are not included in the maximum of eight (8) Ethernet connections.

The meter acting as Modbus master can write data to (export) and read data from (import) Modbus slave devices. The data can be processed by the meter and sent out using other communications methods (email, ION Enterprise, etc.). The meter can also send data directly to other devices on a Modbus network.



NOTE

Modbus master functionality is not available on the ION8650C.

For more information on Modbus mastering, see the *Modbus and ION Technology* technical note.

Configuring the meter as a Modbus master

This sections describes the ION modules involved in using the meter as a Modbus master and using ION Setup or ION Enterprise.

The Modbus master configuration

There is no pre-configured Modbus master framework on your meter. This functionality must be enabled by configuring the following modules in your meter's framework.

Modbus master ION modules

Several ION modules work together to create Modbus master functionality on the meter. Your meter has some or all of these modules, depending on the model and firmware version. See the *ION Reference* for more information on these and other ION modules:

- ◆ **Modbus Master Device module:** reads data from a Modbus slave, which can be an ION meter or third-party device. This imported data can be used by other ION modules. The Modbus Master Device module references a Modbus Master Map module setup register to specify the Modbus format, scaling, and base address settings.
- ◆ **Modbus Master Map module:** provides a common place to hold setup information (used to decode a Modbus response) for specific device types.

This information can be referenced by multiple Modbus Master Device modules.

- ◆ **Modbus Master Options module:** maps any serial connection or Ethernet TCP socket from the Modbus Import, Modbus Export and Modbus Master Device modules to any serial communications port or unique IP address and port number.
- ◆ **Modbus Export module:** provides write functionality.
- ◆ **Modbus Import module:** provides read functionality. This data can then be used by other ION modules.



NOTE

Modbus Export and Modbus Import modules are legacy modules and are provided for backwards compatibility.

See the *Modbus and ION Technology* technical note for more information on configuring Modbus master and the *ION Reference* for more information on the modules used in Modbus mastering.

Using the front panel

You cannot configure Modbus through the meter's front panel. You can only assign the Modbus protocol to communication ports. See "Communications" on page 73 for details.

Use ION Enterprise or ION Setup to perform full Modbus configuration.

Using ION Setup

In ION Setup:

1. Open the Setup Assistant for your meter. See the ION Setup Help for instructions.
2. Select **Communications > 3rd Party Protocols**.
3. Click on the **Modbus Master** tab.
4. Click **Add** to add a Modbus slave device. The **Modbus Device** dialog box appears.

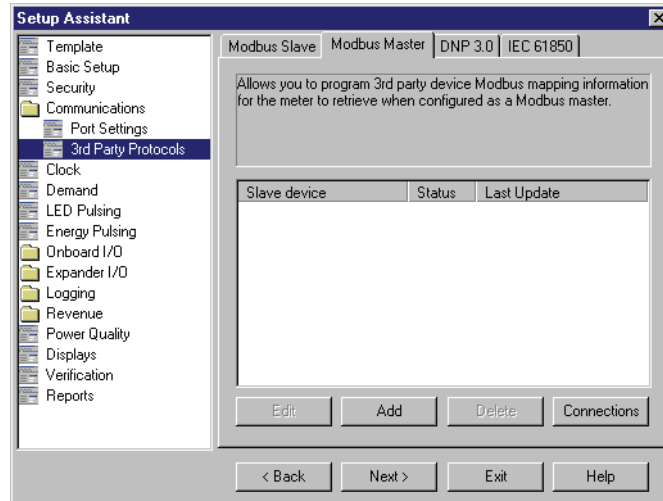

5. Type the slave device's name and a label suffix (if applicable). Select the device type of the slave device from the **Device Type** list (in this example, an ION6200).
6. Type the unit ID of the slave device in the **Slave ID** box.
7. Select the serial or TCP connection you want to configure from the **Connected via** list. This is the connection used by the Modbus master to connect to that slave device. Click **Connections**. The **Modbus Master Connections** dialog box appears.

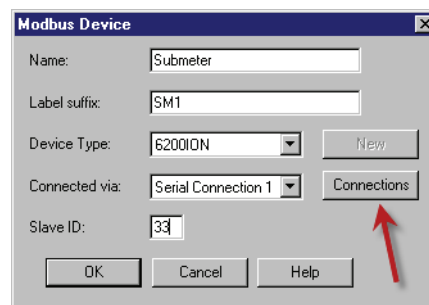

8. Select the tab that corresponds to the connection you are configuring (for example, if you selected TCP Connection 1 from the **Connected via** list, select the **TCP 1** tab), and edit the text boxes as follows:
 - ◆ **Serial Connections:** Select the port that is connected to the Modbus slave devices from the **Assigned Port** dropdown list.
 - ◆ **TCP Connections:** Type the IP address of the Modbus slave device. Ensure that the IP port is 502. You can enter up to ten (10) Modbus slave device IP addresses.



NOTE

For Modbus mastering over RTU, the total number of possible serial connections is limited by the number of physical serial ports on the meter that can Modbus master. The meter has two physical serial ports that support Modbus master (COM1 and COM4).

To Modbus master over Ethernet, the meter must have the optional Ethernet connection.

Click **OK** when you have finished configuring connections to return to the **Modbus Device** dialog box.

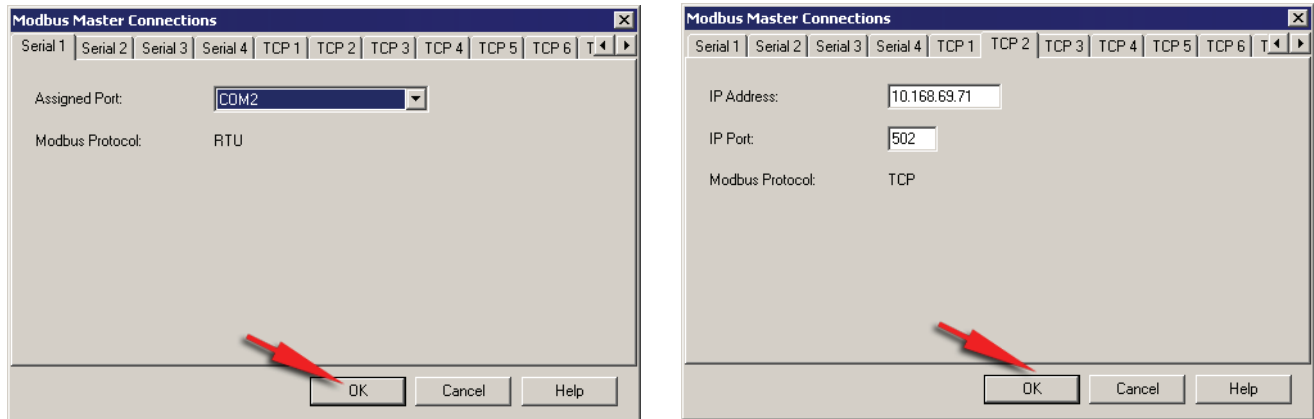

- Click **OK** to add the slave device. The device now appears in the list. Continue adding devices by clicking **Add** until all of your devices are entered.



NOTE

The meter as Modbus master over TCP/IP will attempt to communicate to a slave for up to 100 seconds (as per the RFC1122 standard) before moving on to the next slave device.

See the *Modbus and ION Technology* technical note for more information.

Using ION Enterprise

Use Designer to configure Modbus master functionality on your meter.

- Open the master meter in Designer.
- Navigate to the Modbus Master Options module. Right-click on the center of the module icon to access the ION Module Setup dialog box.
- Configure the setup registers by selecting the setup register you want to change and clicking **Modify**, or by double-clicking on the register.
 - ◆ Serial Connections: Select the appropriate port from the dropdown list.
 - ◆ TCP Connections: Enter the IP address of the Modbus slave device, followed by a colon (:) and the IP port (502), for example, 192.168.0.1:502. You can enter up to 10 unique IP addresses.



NOTE

For Modbus mastering over RTU, the total number of possible serial connections is limited by the number of physical serial ports on the meter that can Modbus master. The meter has two physical serial ports that support Modbus master (COM1 and COM4).

To Modbus master over Ethernet, the meter must have the optional Ethernet connection.

- Create a new Modbus Master Map module for each slave device. The Modbus Master Map module has two setup registers:

- ◆ Device Type: Enter the type of device that you want to map. This value is referenced by the Modbus Master Device module.
 - ◆ Device Map: This is the data that you want to access from the Modbus slave device, in the form of text strings containing the parameter label, register value, data format, etc.
5. Create a new Modbus Master Device module for each slave device. Configure the following setup registers in the Modbus Master Device module:
 - ◆ Connection: Select the serial or TCP connection being used to communicate with the slave device.
 - ◆ Slave Addr: Type the unit ID of the slave device.
 - ◆ Device type: Type a device type string. Ensure that this is the same as the device type entered in the Modbus Master Map module.
 - ◆ Slave name: Type a name for the slave device.
 6. Link the module inputs and outputs as required.
 7. Select **File > Send & Save** when you are finished.

See the online *ION Enterprise Help* for more information on creating, modifying and linking modules in Designer and the *ION Reference* for details of module setup and output registers.

Using the DNP 3.0 protocol

The Distributed Network Protocol Version 3.0 (DNP 3.0) is an open protocol used in the electric utility industry for communications and interoperability among substation computers, remote terminal units (RTUs), intelligent electronic devices (IEDs; for example, meters), and master stations.

Your meter can be integrated into a DNP network as a DNP slave, using the DNP Slave Import, DNP Slave Export and DNP Slave Options modules. For more information on the various DNP modules, see the *ION Reference*.

Your meter supports a maximum of three concurrent connections (or “sessions”) using the DNP 3.0 protocol; one for each serial port, up to three using Ethernet, or a combination of both. Combinations available depend on the meter’s communications options. A session consists of all incoming and outgoing DNP master/slave traffic on one of the meter’s communications ports.

Consult the DNP User’s Group at <http://www.dnp.org/> to learn more about the protocol.

The factory DNP 3.0 configuration

Your meter is pre-configured with a DNP framework that allows for basic DNP slave functionality. DNP Slave Export modules are used to send data to the DNP master while DNP Slave Options modules provide per-session settings such as communications options. Although some minor setup of the framework is necessary before it is enabled (assigning the DNP protocol to the communications ports, for example), most module settings should not require alteration.

For information on your meter’s default DNP map and factory configuration, see the *ION8650 DNP 3.0 Device Profile*.

Importing data using DNP 3.0

Data can be imported into the meter from a DNP control relay or analog output device. DNP Slave Import modules are used to take a DNP Analog output or Binary output object and map them into ION registers.



NOTE

DNP Slave Import modules are not part of the factory DNP framework and must be added manually. Refer to the DNP Slave Import module description in the *ION Reference* for details. Refer to the *DNP 3.0 Device Profile* protocol document for a description on the DNP 3.0 communications protocol used by the meter.

Configuring DNP 3.0

If the factory DNP configuration does not suit your needs, you can relink the existing DNP Slave Export modules to access a different set of parameters through DNP. Alternately, you can add additional DNP Slave Export modules and link the desired parameters to them.

If your DNP network requires data in a format different than that provided by the factory DNP configuration, you can edit the setup registers in the DNP Slave Export modules and the DNP Slave Options modules. Do not make any changes to the DNP Slave Options modules' setup registers unless you understand the effects each change will cause. Refer to the *ION Reference* for complete details on DNP Slave Export and DNP Slave Options module function.

For detailed information on configuring your meter to use DNP, see the *Multiport DNP 3.0 and ION Technology* technical note.

Using the front panel

You cannot configure DNP through the meter's front panel. You can only assign the DNP 3.0 protocol to communication ports. See "Communications" on page 73.

Using ION Setup

In ION Setup:

1. Open the Setup Assistant for your meter. See the ION Setup Help for instructions.
2. Select **Communications > 3rd Party Protocols** and click on the **DNP 3.0** tab.
3. Select the DNP feature you want to configure (for example, Parameter Map) and click **Edit**.

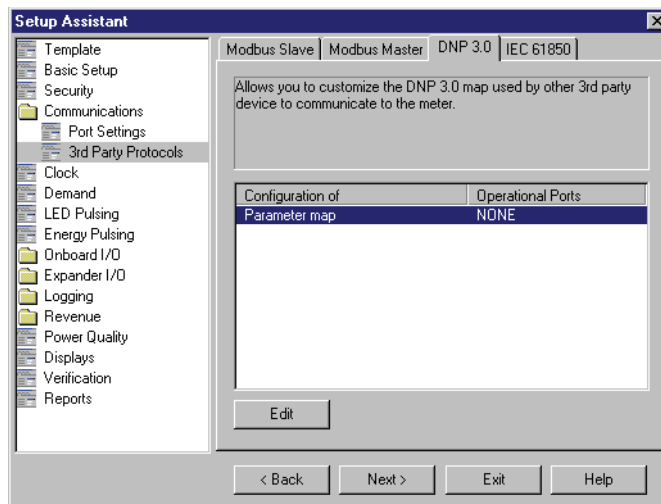

The Setup Assistant wizard guides you through DNP configuration. See the *ION Setup Help* for more information.

Using the IEC 61850 protocol

IEC 61850 is an Ethernet-based protocol designed for electrical substations. It is a standardized method of communications, developed to support integrated systems composed of multi-vendor, self-describing IEDs (intelligent electronic devices) that are networked together to perform monitoring, metering, and real-time, non-critical protection and control.



NOTE

You must have an Ethernet connection on your meter to be able to use IEC 61850.

Your meter can be integrated into an IEC 61850 system as an IED (or server), supporting a maximum of five concurrent IEC 61850 client connections and one FTP connection (used for transferring data or configuration files).

Use ION Setup to enable IEC 61850 control of your meter's optional I/O ports and to map additional meter values into IEC 61850. See "Configuring IEC 61850" on page 110 for more information and safety precautions. All other IEC 61850-specific configuration is done using an IEC 61850 configuration tool and your IEC 61850 client software.

Additional information

For more information, refer to the following:

- ◆ *IEC 61850 and ION Technology* protocol document provides more information about how IEC 61850 is implemented on your meter.
- ◆ *ION Reference* describes the IEC 61850 ION modules.
- ◆ The IEC (International Electrotechnical Commission) website at www.iec.ch provides general information about the IEC 61850 protocol.

The default IEC 61850 configuration

Your meter's factory template includes an IEC 61850 framework already configured with a default set of meter data mapped into IEC 61850. This default set of meter data is used in the default data sets and reports in the ICD files available from the website.

You must load a valid IEC 61850 configuration (CID) file into the meter in order to activate the IEC 61850 features of your meter.

Your meter has five (5) dedicated IEC 61850 client connections and one FTP connection.

Configuring IEC 61850

No meter port configuration is required for IEC 61850, but the meter must have an operating Ethernet connection for IEC 61850 client connections and for FTP transmission of configuration and data files.

Configuring additional ION data into IEC 61850

The IEC 61850 ICD file for your meter contains a comprehensive set of default data values. Additional meter data values can be made available in IEC 61850 by mapping the ION data to the GGIO Custom Analog or GGIO Custom Digital modules.

Using the front panel

You cannot configure IEC 61850 through the meter's front panel.

Using ION Setup

In ION Setup:

1. Open the Setup Assistant for your meter. See the ION Setup Help for instructions
2. Select **Communications > 3rd Party Protocols** and select the **IEC 61850** tab.

The CID status line indicates whether the meter has received and validated an IEC 61850 CID file and is operating as an IEC 61850 server:

- ◆ **IEC 61850 stack running:** the meter has received and validated an IEC 61850 CID file and is operating as an IEC 61850 server.
- ◆ **Missing CID file:** no IEC 61850 CID file is loaded into the meter.
- ◆ **Invalid CID file:** the IEC 61850 CID file is invalid.

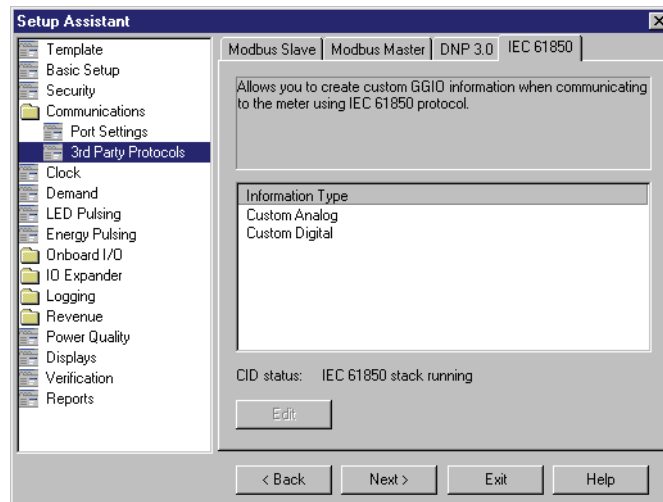

3. Select the custom option that matches the data you want to map and click **Edit**. Custom Analog and Custom Digital allow you to map additional numeric (analog) or Boolean/binary (digital) values into IEC 61850.



NOTE

Because Custom Analog and Custom Digital are ION modules, they can be configured at any time, regardless of CID status.

4. Expand the Available registers list and select the custom analog or digital value that you want to map into IEC 61850. Highlight the IEC 61850 leaf you want to map onto and click the >> button to map the value. Click the << button to remove

the value. Select **Show all available registers** to show all the ION modules and their registers. Click **OK** to send your changes to the meter.

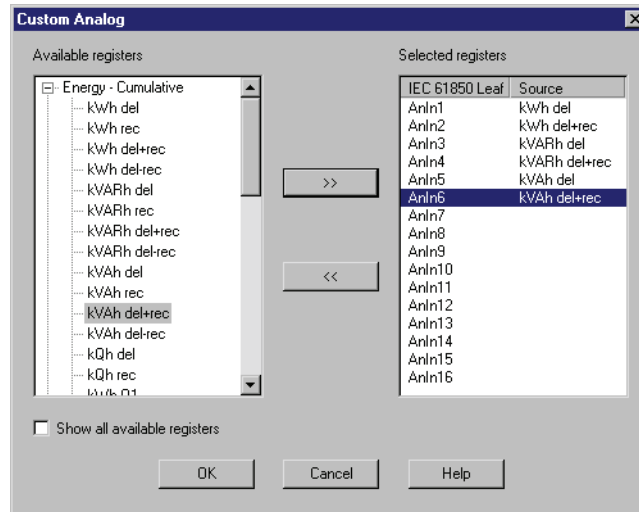

Configuring meter digital I/O control via IEC 61850

By default, your meter's I/O status values are available via IEC 61850. You can configure the meter to provide IEC 61850 control of the meter's optional digital output hardware ports by configuring the GGIO Onboard ION module and the Digital Output module.



NOTE

Refer to "Inputs / Outputs" on page 131 for details on how to configure your meter's digital inputs and outputs.

To control your meter's digital outputs via IEC 61850, you must configure the Digital Output module's *Source* register to be the IEC 61850 digital status value (*SPCS.stVal*) output register. This output register is written by the IEC 61850 system into the IEC 61850 GGIO Onboard module. You must also disconnect the Digital Input module's *Status* output register from the IEC 61850 GGIO Onboard *Digital Output Status* input register or else you will create a circular reference and the modules will go offline. Refer to the *ION Reference* for details of the IEC 61850 GGIO Onboard module.

WARNING

HAZARD OF UNINTENDED OPERATION

- Do not use the meter for critical control or protection applications where human or equipment safety relies on the operation of the control circuit.
- Be aware that an unexpected change of state of the digital outputs may result when the supply power to the meter is interrupted or after a meter firmware or template upgrade.

Failure to follow these instructions can result in death, serious injury or equipment damage.

Using ION Setup

In ION Setup:

1. Connect to your meter in Advanced Mode.
2. Navigate to the GGIO Onboard folder and double-click on the module in the right-hand pane.
3. Select the **Setup Registers** tab.
4. Select the *SPCS Control Mode* register that corresponds to the digital output you want to control through IEC 61850 and click **Edit**. A dialog box appears.
5. Select IEC 61850 CTLVAL from the dropdown list and click **OK**.

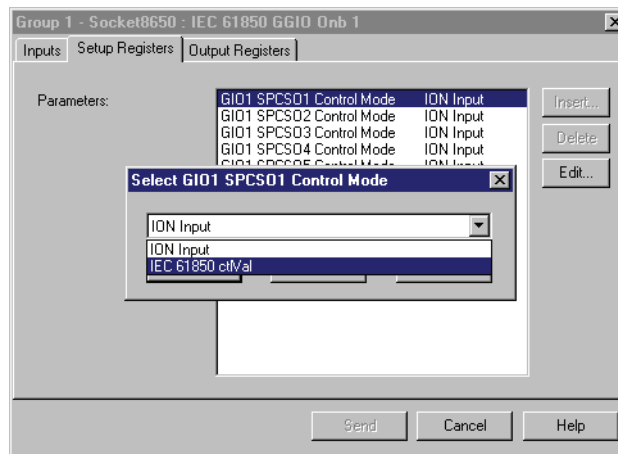

6. Select the **Inputs** tab.
7. Select the digital output *Status* register for the digital output that you want to control through IEC 61850. Click **Delete**.



NOTE

The digital input *Status* register must be deleted in order to prevent a circular reference that will cause the affected modules to go offline.

8. Click **Send** to send your changes to the meter.
9. Navigate to the Digital Output folder.
10. Double-click on the Digital Output module that you want to control through IEC 61850.
11. Select the **Setup Registers** tab and confirm that the Digital Output module's setup registers are appropriately configured.
12. Select the **Inputs** tab.
13. Select the *Source* register and click **Edit**.

14. Navigate to the IEC 61850 GGIO Onboard module and select the *SPCS.stVal* output register that corresponds to the digital output.

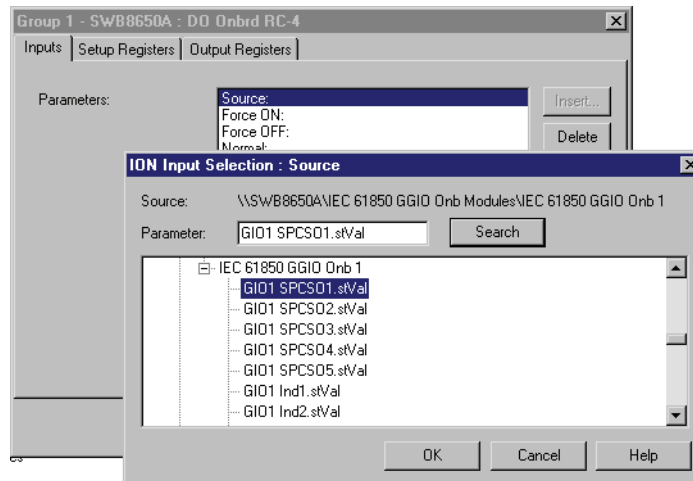

15. Click **OK** and **Send** to save your changes to the meter.

Configuring MV-90

ION8650 meters can provide energy values to an MV-90 data management system. In order to recognize and communicate with your meter, the MV-90 software requires meter configuration data to create a master (master.dat) file for your meter.

Use ION Setup to:

- ◆ generate a meter configuration (master.dat) file for your meter that can be imported directly into your MV-90 system or printed for manual data entry.
- ◆ configure your meter's revenue data in MV-90 E-File data format.
- ◆ export an .hhf file to transfer revenue data from your meter to your MV-90 system using a handheld device.

For more information, see the *MV-90 and ION Technology* technical note, available from the website.

Chapter 9 Time

This chapter covers the meter’s clock and time synchronization, including IRIG-B GPS time synchronization.



NOTE

References to NTP in ION devices or documentation should be interpreted as SNTP.

In this chapter

- ◆ **Meter clock configuration** 118
- ◆ **Time synchronization** 119
 - IRIG-B time synchronization 119
- ◆ **Configuring the meter clock** 120
 - Using the front panel 120
 - Using ION Setup 120
 - Using Designer 120
 - Clock module settings 121

Meter clock configuration

The Clock module controls the meter's internal clock, which provides timestamps for data logged by the device. The clock needs to be configured properly to ensure that internally logged data has accurate timestamp information. The clock settings do not affect any data logs that are stored external to the meter. The Clock module also receives the time synchronization signals sent to it by a workstation running ION Enterprise or ION Setup, updating the device's clock when required.

The Clock module's *Clock Source* setup register defines how the meter's internal clock auto-corrects drift from its internally calculated time. A separate time source (such as a GPS receiver or a DNP Master) can be used to synchronize the clock through a communications channel. By default, the clock is set to synchronize from the line frequency.

See the *ION Reference* for more information on the Clock module and the *Time Synchronization & Timekeeping* technical note for more information about time and ION meters.

Time synchronization

Time synchronization lets you synchronize your meter's internal clock with all of the other meters, devices, and software in a network. After the meter is synchronized, all the data logs stored on the meter have timestamps that are relative to a uniform time base. This allows you to achieve precise sequence-of-events and power quality analyses using the data logged on the meter. Use ION Enterprise or ION Setup to broadcast time signals across the network, or utilize an external source (such as a DNP Master or IRIG-B) to synchronize your meter's clock.

Refer to the *Time Synchronization & Timekeeping* technical note for more information on implementing time synchronization.

IRIG-B time synchronization

ION8650 meters come with an IRIG-B connection for GPS time synchronization using unmodulated IRIG-B time code data. The meter is pre-configured to synchronize via IRIG-B GPS, after you wire the meter to a GPS receiver and set the clock *Time Sync Source* and *Clock Source* parameters.

Any GPS receiver that outputs unmodulated IRIG-B time code data can be used as a time synchronization source.

You can configure IRIG-B time synchronization to update if the GPS receiver is locked onto a satellite source or to update regardless of whether or not the GPS receiver is locked onto a satellite source. Refer to the Clock module description in the *ION Reference* for more information on this setting.

IRIG-B standard and specifications

The standard is outlined in the IRIG-STANDARD 200-04 "IRIG Serial Time Code Formats" prepared by the Timing Committee, Telecommunications and Timing Group, Range Commanders Council.

Accuracy	+/- 1 ms
Format	IRIG-B00x ¹ format (unmodulated IRIG-B time code)
Nominal Voltage	5 Vdc +/- 10%
Maximum Voltage	8 Vdc

¹Coded expressions 4 to 7 are supported but the year data is not used by the meters.

Diagnostic module outputs and event log entries

The Diagnostic module output registers and event log entries update as described in the *Time Synchronization & Timekeeping* technical note, with the following exceptions:

- ◆ The GPS Receiver Status output register in the Diagnostics module is set to N/A.
- ◆ The GPS locked and GPS unlocked event log entries are not generated.

Configuring the meter clock

Use ION Enterprise or ION Setup to change the meter's clock settings.

Using the front panel

You cannot configure the time using the front panel.

Using ION Setup

In ION Setup:

1. Open the Setup Assistant for your meter. See the ION Setup Help for instructions
2. Select the **Clock** screen.

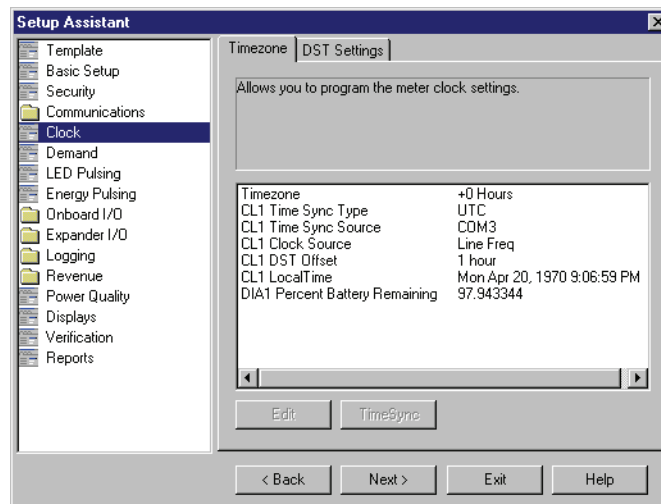

3. Click the **Timezone** tab to configure your meter's clock settings. Select a parameter and click **Edit** to change.



NOTE

For IRIG-B, set the Time Sync Source to IRIG-B and the Clock Source to COMM.

4. Click on the **DST Settings** tab to configure your meter's daylight savings periods for up to 20 years. Select a parameter and click **Edit** to change.
5. Connect the meter to the time sync source (such as a GPS receiver output) if applicable.

Using Designer

Open your meter in Designer and navigate to the Meter Clock Setup framework. Right-click on the Clock module to edit.

Clock module settings

The setup registers in the Clock module specify timezone and Daylight Savings Time (DST) parameters and time synchronization functions. Refer to the Clock module description in the ION Reference for information on advanced settings you can configure.

Setup register	Function	Default
Timezone	Sets the timezone the device is in, relative to Greenwich Mean Time.	0
DST Start 1 ... DST Start 20	The date and time when DST begins for 20 separate years.	Refer to the <i>ION Device Template Reference</i> for the DST Start and DST End defaults for the twenty separate years.
DST End ... DST End 20	The date and time when DST ends for 20 separate years.	
DST Offset	The amount of time the clock is changed when DST begins or ends.	3,600 seconds
Time Sync Source	Specifies the communications port that receives time sync signals. For Ethernet, it also specifies which protocol can time sync the meter.	COM3
Time Sync Type	Specifies the type of time sync signal (Local or Universal time).	UTC
Clock Source	Specifies the clock's time synchronization signal source (line frequency, communications signals, or internal crystal).	Line Frequency
Percent Battery Remaining	The setting displays the approximate percentage of battery life remaining. You should only need to edit this parameter if you have replaced the battery.	Not applicable
Local Time	The parameter is show for information purposes only. It displays the current local time on the meter. To change this, you must time sync the meter.	Not applicable



TIP

When modifying setup registers of the Clock module in Designer, use the Format option to convert between UNIX and conventional time. Refer to the description of the Clock module in the online *ION Reference* for more details.

Typically, the *DST Start* and *DST End* registers do not need to be reconfigured for users in North America. The factory defaults are the DST start and end dates for 20 years, in UNIX time (the number of seconds since 00:00:00 UTC on Jan. 1, 1970).

Refer to the *Time Synchronization & Timekeeping* technical note for further details on using the meter's time synchronization functions. Refer to the *ION Reference* for more information on the Clock module and its registers.

Chapter 10 Demand

This chapter explains how to configure and view demand values on your meter.

In this chapter

- ◆ **Introduction** **124**
 - Sliding window demand 124
 - Peak demand 124
 - Illustration of the basic demand framework 124

- ◆ **Configuring demand** **125**
 - Using the front panel 125
 - Using ION Setup 125
 - Using Designer 125
 - Sliding Window Demand module settings 125
 - Configuring demand reset lockout time 126

- ◆ **Demand Forgiveness** **127**
 - Additional Information 128
 - Configuring Demand Forgiveness 129
 - Using the Front Panel 129
 - Using ION Setup 129

Introduction

Demand is a measure of average power consumption over a fixed time interval. Peak (or maximum) demand is the highest demand level recorded over the billing period. Demand is measured using Sliding Window Demand modules. These modules are configured to calculate the average current demand and kW, kVAR and kVA demand. The setup registers in the demand module defines time intervals for demand calculations, setting the sensitivity of the module's operation.

The meter has a default demand framework that is suitable for most utility applications. However, if needed, you can customize it for your specific application.

Sliding window demand

Sliding window demand is often referred to as rolling block demand. To compute sliding window demand values, the meter uses the sliding window averaging (or rolling interval) technique which divides the demand interval into sub-intervals.

The demand is measured electronically based on the average load level over the most recent set of sub-intervals. This method offers better response time than fixed interval methods.

The meter uses the Sliding Window Demand module to calculate sliding window demand.

Peak demand

Power utilities generally bill commercial customers based on their peak usage levels, called *peak demand* (in kW) and *energy consumption* (in kWh). Demand is a measure of average power consumption over a fixed time interval, typically 15 minutes. Peak (or maximum) demand is the highest demand level recorded over the billing period. *Sliding window demand* is one method of measuring demand.

Illustration of the basic demand framework

In the following diagram, the Sliding Window Demand module labeled “Demand” calculates demand from the power input by measuring and averaging the power over a set interval. The demand value is then output to a Maximum module labeled “Peak Demand” that records the highest demand value over time (peak demand).

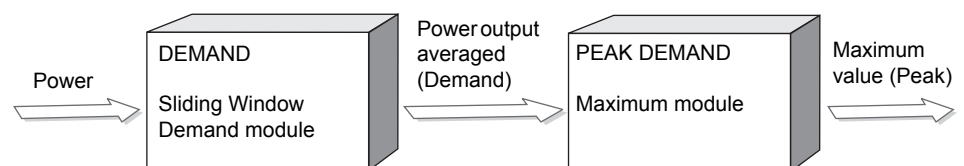

For more information on ION modules, refer to the online *ION Reference*.

Configuring demand

Use ION Enterprise or ION Setup to change your meter's demand settings.

Using the front panel

You cannot use the front panel to configure demand.

Using ION Setup

The Demand screen in the Setup Assistant helps you configure sliding window (or rolling block) demand. This screen also contains two registers used for configuring sliding window demand while the meter is in TEST mode.

In ION Setup:

1. Open the Setup Assistant for your meter. See the ION Setup Help for instructions.
2. Select the **Demand** screen.

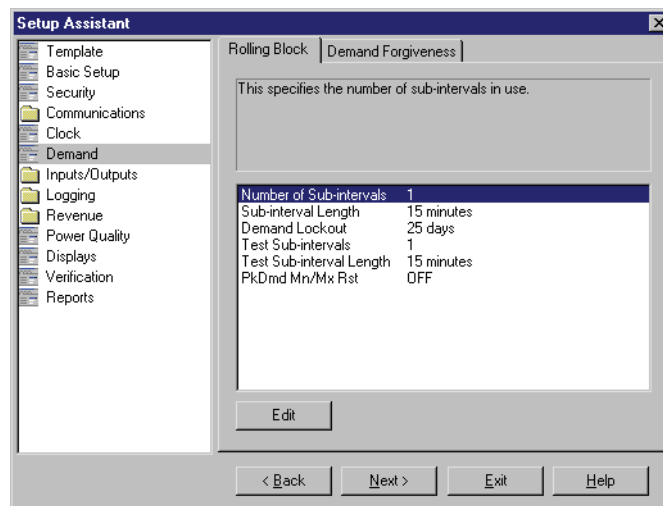

3. Select a register and click **Edit** to configure.

Using Designer

Open your meter in Designer and navigate to the Demand Setup framework. Click on Demand Setup to access the Sliding Window Demand modules. Right-click on a module to edit.

Sliding Window Demand module settings

The following table outlines the sliding window demand settings. See the *ION Reference* for more information about the Sliding Window Demand module.

Setup register	Function	Default
Sub Intvl	The time, in seconds, in the sliding window demand sub-interval.	900
#SubIntvls	The number of sub-intervals in the sliding window.	1
Pred Resp	The speed of Predicted Demand calculations; use higher values for faster prediction (70 to 99 recommended).	70
Update Rate	Defines the update rate of the <i>SWinDemand</i> output register	Varies depending on the module

Configuring demand reset lockout time

The demand reset lockout time sets the minimum time allowed between consecutive demand resets; the meter ignores any attempts to reset demand that occur within the lockout time. The default demand lockout time is 25 days (2160000 seconds).

Using the front panel

1. Hold down the **ALT/ENTER** button to access the SETUP menu.
2. Use the up and down arrows to highlight DISPLAY SETUP then press the **ALT/ENTER** button.
3. Use the up and down arrows to highlight DMD LOCK TO then press the **ALT/ENTER** button.
4. Use the up and down arrows to enter a demand lockout time in seconds. Press **ALT/ENTER** to apply the value.

Using ION Setup

In ION Setup:

1. Open the Setup Assistant for your meter. See the ION Setup Help for instructions
2. Select the **Demand** screen and click the **Rolling Block** tab.
3. Select *Demand Lockout* and click **Edit**. Enter a demand lockout time in days (in Elapsed Interval Format) or seconds (in Numeric Bounded Format). Click **OK**.

Demand Forgiveness

Demand Forgiveness is the time programmed to the meter during which demand (and therefore peak demand) will not be calculated in the power restoration period following a total power outage.

During power-up following a complete power outage, customer equipment consumes a higher than normal amount of power. Demand Forgiveness lets a utility forgive the customer for peak demand penalties that can arise from power-up following a power outage (should the outage exceed a user-specified period of time).

Demand and Peak Demand module behavior during Demand Forgiveness

A peak demand value is the highest demand value since the last peak demand reset. The Demand Forgiveness framework sets the Sliding Window Demand module inputs to zero during a Demand Forgiveness period. This method allows demand interval data to accurately reflect a complete interval that includes data:

- ◆ prior to an outage
- ◆ during the Demand Forgiveness period (zero values)
- ◆ after the Demand Forgiveness period



NOTE

During a Demand Forgiveness period, Sliding Window Demand module inputs are set to zero and do not reflect actual demand. *These values should not be used to calculate energy for billing purposes.* Energy values are not affected and reflect actual energy consumption during the Demand Forgiveness period.

The settings listed below must be made configured for Demand Forgiveness functionality. These settings can be accessed from ION Setup; refer to “Using ION Setup” on page 129.

- ◆ *Minimum Outage Duration* lets you specify the amount of time (in seconds) that the power must be out before the Demand Forgiveness period begins.
- ◆ *Demand Forgiveness Duration* lets you specify the amount of time (in seconds) that demand is forgiven (demand inputs are zero).
- ◆ *Update Rate* lets you define the update rate of the SWinDemand output register. It is set to Every Second by default for revenue-related demand modules; with this setting, demand value measured is updated once per second.
- ◆ *Outage Voltage* (line-to-line average in unscaled meter units) lets you define a voltage level that is considered an outage. This is set to 20 volts by default.

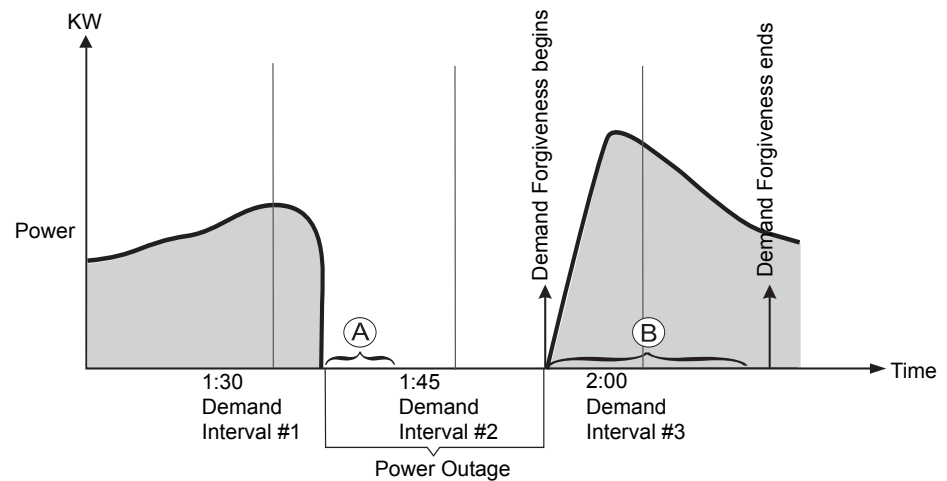

- Ⓐ The specified amount of time that the power must be out before demand is forgiven.
- Ⓑ The specified amount of time that demand is delayed during the Demand Forgiveness period.

The preceding diagram shows an example of a meter that is set up for Demand Forgiveness. The Sliding Window Demand module is averaging demand values at 15 minute intervals. During interval #1, the meter has a power outage that lasts for 18 minutes. The power outage is defined by a system voltage of 20 volts which is specified in the *Outage Voltage* setting. The *Minimum Outage Duration* setting is specified as 10 minutes, so this is the amount of time that the power must be out before demand can be forgiven. The *Demand Forgiveness Duration* setting is specified as 1800 seconds (30 minutes), so for 30 minutes following power restoration, demand inputs are zero. The power is restored during interval #2, where the surge of power consumption during power-up is included in the Demand Forgiveness period and has a value of zero.

Additional Information

The following points are important to note:

- ◆ The following demand input values are zero for kW, kVA, and kVAR during the Demand Forgiveness period:
 - ◆ Delivered
 - ◆ Received
 - ◆ Delivered + received
 - ◆ Delivered – received
 - ◆ Q1, Q2, Q3, Q4
- ◆ If a new peak is set prior to a power outage, it persists.
- ◆ Even though demand is zero during the Demand Forgiveness period, a new peak can be set if the demand was very high prior to the power outage or after the Demand Forgiveness period ends.
- ◆ Demand Forgiveness works for auxiliary and blade powered meters.
- ◆ All ION modules in the Demand Forgiveness framework are fully locked.

- ◆ If a Demand Forgiveness period is initiated, and another power outage occurs that is less than the time specified in the *Minimum Outage Duration* setting, the Demand Forgiveness period continues. If a second outage is greater than the time specified in the *Minimum Outage Duration* setting, the Demand Forgiveness period restarts.
- ◆ Both the power outage downtime and the Demand Forgiveness downtime are stored within the Demand Forgiveness framework. The Store modules preserve a timestamp that is viewable in Vista.
- ◆ The Sliding Window Demand module *Update Rate* setup register must be set to EVERY SECOND (this is the default for revenue-related demand modules).
- ◆ If Demand Forgiveness is enabled on an auxiliary-powered meter and there is no power on the blades, the meter assumes that this is an outage. When power is applied to the blades, demand is forgiven for the specified time.
- ◆ If Demand Forgiveness is enabled and the meter is unplugged for servicing or other reasons, the Demand Forgiveness framework assumes there was an outage and demand is forgiven for the specified time.
- ◆ For meters where Demand Forgiveness is enabled at the factory (for example, certain certified revenue-sealed meters), demand is not measured when the meter is first put into service. Instead demand is forgiven for the specified time.

Configuring Demand Forgiveness

Demand Forgiveness is disabled by default. Use ION Setup to enable Demand Forgiveness.



NOTE

If Demand Forgiveness is enabled, do not use demand values to calculate energy for billing purposes. Energy values are not affected and reflect actual energy consumption during the Demand Forgiveness period.

Using the Front Panel

You cannot enable or edit Demand Forgiveness settings using the front panel.

Using ION Setup

In ION Setup:

1. Open the Setup Assistant for your meter. See the ION Setup Help for instructions.
2. Select the **Demand** screen and click the **Demand Forgiveness** tab.
3. Select *Demand Forgiveness Enable*. Click **Edit** and select ON. This enables Demand Forgiveness.
4. Select *Min Outage Duration* and click **Edit**.

Type the amount of time (in seconds) that the power must be out before the Demand Forgiveness period starts. Click **OK**.

5. Select *Demand Forgiveness Duration* and click **Edit**.

Type the amount of time (in seconds) that demand is forgiven (demand inputs are zero). Click **OK**.

6. Select *Outage Voltage* if required and click **Edit**.

Type the minimum voltage (line-to-line average in unscaled meter units) that is considered an outage; this is set to 20 V by default but you can adjust this. Click **OK**.

Chapter 11 Inputs / Outputs

This chapter provides information on the meter's various digital and analog inputs and outputs (I/O).

Refer to your *ION8650 Installation Guide* for instructions on wiring inputs and outputs and for the general meter I/O specifications.

You can use the ION8650's onboard I/O for a variety of applications.

For example, you can use a Form A digital input to monitor a breaker to verify how many times the breaker trips. When the breaker reaches its limit for the number of trips, you can use the digital output to light an LED next to the breaker so field personnel are alerted. You can also use a Form C digital output to send KYZ pulsing information to third-party system equipment.

In this chapter

- ◆ **Introduction** **132**
 - Specifying an I/O port in a module 134
 - Using the onboard digital outputs 135
 - Digital Output modules 135
 - Using the optional onboard digital inputs 136
 - Using the optional analog outputs 137
 - Configuring inputs and outputs 138
 - Using the front panel 138
 - Using ION Setup 138
 - Using Designer 139

Introduction

The meter's digital and analog I/O ports simplify data gathering by importing a variety of data types into a single, common system. You need to configure the following modules in order to use the meter's for digital and analog I/O capabilities.

- ◆ **Digital Input:** Digital (status) inputs can be used for monitoring external contacts or pulse counting applications, and are controlled by Digital Input modules. This module tells the meter how to interpret incoming signals.
- ◆ **Digital Output:** Digital outputs are used for hardware relay control or pulse counting applications. The outputs can be controlled by Digital Output modules, Pulser modules, or Calibration Pulser modules, depending on the application (relay switching or energy pulsing). An example of a commonly used application for each module is listed below.
 - ◆ **Digital Output module:** monitors a change of state to control relay operation via a hardware output device.
 - ◆ **Pulser module:** transfers high-speed pulses to a hardware pulse counting device that is used to track energy usage.
 - ◆ **Calibration Pulser module:** integrates instantaneous power inputs, then outputs high-speed pulses to an LED that can be monitored to verify revenue meter calibration.

All of these modules can act as intermediaries between the hardware port and the other modules in the meter. They define the characteristics of outgoing signals.

- ◆ **Analog Output:** Analog outputs can deliver a continuous DC signal, and are controlled by the Analog Output modules.

See the *ION8650 Installation guide* for I/O wiring instructions.

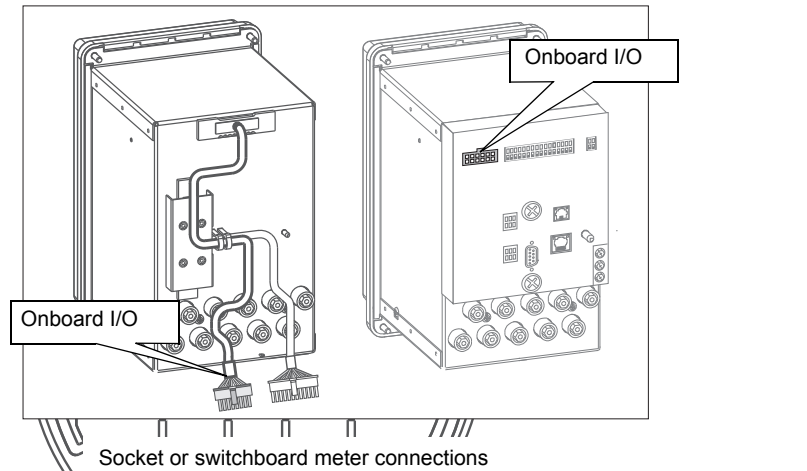

Expanded I/O (and serial COMs): Molex Micro-Fit 24 pin male connector.

Optional Onboard I/O: 16 pin male connector.

Optional I/O Expander for serial communications and expanded I/O. For more information, see the *PowerLogic I/O Expander Installation Guide*.

Serial COMs
 COM1: RS-232 or RS-485.
 COM4: RS-485, depending on the options ordered for your meter.

Depending on the version of the I/O Expander that you ordered, you can have:
 Eight Form A digital inputs.
 Four Form C digital outputs.
 Four Form A digital outputs or four analog outputs.

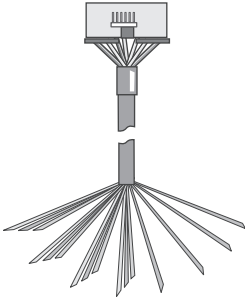
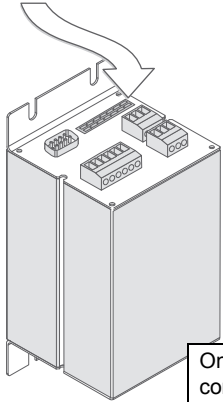

Onboard I/O breakout cable with female connector and sixteen bare-ended wires.

See your meter's *Installation Guide* for installation instructions and information on determining the I/O configuration available on your meter.

I/O Expander for ION8650 meters

For analog or additional digital I/O with the meter, you can use an external I/O Expander. Information for the analog and digital I/O Expander options is available in the *I/O Expander Installation Guide*.

Specifying an I/O port in a module

For detailed information and instructions on configuring Analog and Digital I/O modules, see the *ION Reference*.

Configure the Digital Output, Digital Input, Analog Output, Pulser, and Calibration Pulser modules to specify which port handles the outgoing or incoming signals. To assign a port to one of these modules, simply modify the *Port* setup register by picking a port from the enumerated list. This can be done with both ION Setup and the Designer component of ION Enterprise.

The following table describes the ports that can be configured (in the Digital Output, Digital Input, Analog Output, and Calibration Pulser modules) to handle outgoing or incoming signals.



NOTE

You must confirm the meter I/O options (onboard and/or I/O Expander) to determine which of the following apply to your meter.

ION module type	ION module name	Hardware port (device label)	Port name (ION label)	Description
Onboard digital output ports				
Digital Output (DO)	DO Onbrd RA-1	A1	On-Board FormA Out 1	Digital Output port 1 (Form A Solid State)
	DO Onbrd RC-1 to DO Onbrd RC-4	C1 to C4	On-Board FormC 1 to On-Board FormC 4	Digital Output port 1to 4 (Form C Relay)
Calibration Pulser	VARh Pulse LED ¹	Watt LED	WATT LED	LED Output
	Wh Pulse LED ¹	VAR LED	VAR LED	LED Output
Onboard digital input ports				
Digital Input (DI)	DI-S9	S1	On-Board FormA 1	Digital Input port 1 (Form A)
	DI-S10, DI-S11	S2, S3	On-Board FormA2 to On-Board FormA3	Digital Input port 2 to 3 (Form A)
I/O Expander digital output ports				
Digital Output (DO)	DO RC-1 to DO RC-4	C-1 to C-4	I/O Exp FormC 1 to I/O Exp FormC 4	Digital Output port 1 to 4 (Form C)
	DO RA-1 to DO RA-4	A-1 to A-4	I/O Exp FormA 1 to I/O Exp FormA 4	Digital Output port 1 to 4 (Form A)
I/O Expander digital input ports				
Digital Input (DI)	DI-S1 to DI-S8	A-1 to A-4	I/O Exp In 1 to I/O Exp In 8	Digital Input port 1-8 (Form A)
I/O Expander analog output ports				
Analog Output (AO)	Analog Out 1 to Analog Out 4	A1 to A4	I/O Exp AnOut 1 to I/O Exp AnOut 4	Analog Output port 1 to 4

Configuring energy pulsing applications

To configure the LED outputs for energy pulsing applications (for example, kVAh), see “Energy pulsing” on page 141.

Using the onboard digital outputs

Digital outputs are used for hardware relay control or pulse counting applications. For example, the meter’s digital outputs can provide on/off control signals for capacitor banks, generators, and other equipment. The digital output ports can also send out status signals or kWh pulses, if the receiving device determines energy usage by counting pulses.

A meter with the optional onboard I/O provides four Form C digital outputs and a Form A digital output. All digital outputs can deliver a continuous signal or a pulse.

Contact Schneider Electric for complete information regarding relay applications.

Digital Output modules

WARNING

HAZARD OF UNINTENDED OPERATION

- Do not use the meter for critical control or protection applications where human or equipment safety relies on the operation of the control circuit.
- Be aware that an unexpected change of state of the digital outputs may result when the supply power to the meter is interrupted or after a meter firmware or template upgrade.

Failure to follow these instructions can result in death, serious injury or equipment damage.

These outputs can be controlled with Digital Output modules, Pulser modules, or Calibration Pulser modules, depending on the application. For relay and control, the Digital Output module is used. For pulsing applications, the Pulser or Calibration Pulser modules are generally used.

You must configure these modules in order to use the output ports.

- ◆ **Calibration Pulser modules** allow you to generate high accuracy energy pulses for verifying meter accuracy. They integrate instantaneous power inputs.
- ◆ **Digital Output modules** accept Boolean inputs, and output a continuous signal or pulses.
- ◆ **Pulser modules** convert instantaneous pulses to pulses or transitions.

Configure the settings of the controlling module to match your requirements. Ensure that the module’s *Port* setup register matches the meter’s output that you want to control.

For detailed information and instructions on configuring these modules, see the *ION Reference*. For information on the default settings for the modules, see the *ION Device Template Reference*.

The available settings for these modules are as follows:

ION module	Setup registers	Available settings	Description
Digital Output	Port	Not Used WATT LED VAR LED I/O Exp FormC 1 I/O Exp FormC 2 I/O Exp FormC 3 I/O Exp FormC 4 I/O Exp FormA 1 I/O Exp FormA 2 I/O Exp FormA 3 I/O Exp FormA 4 On-Board Form C 1 On-Board Form C 2 On-Board Form C 3 On-Board Form C 4 On-Board FormA Out 1	Determines the output hardware channel
	Pulse Width	0 to 2000000	Pulse Width, in seconds (0 for continuous pulse)
	Polarity	<i>Fixed at NON-INVERTING</i>	Specifies a non-inverted (or level) pulse
	EvLog Mode	Log on or Log off	Determines whether or not to log status changes in the Event Log
Pulser	Port	As per Digital Output, above	Determines the output hardware channel
	PulseWidth	0.020 to 2000000	Pulse width, in seconds
	OutputMode	Pulse or KYZ	Full pulse or KYZ (transition pulse)
	Polarity	<i>Fixed at NON-INVERTING</i>	Specifies a non-inverted (or level) pulse
Calibration Pulser	Port	As per Digital Output, above	The output hardware channel
	Pulse Width	0.010 to 1.000	Pulse Width, in seconds
	Kt	0.01 to 1000000000	Watts per pulse
	Int Mode	Forward, Reverse, Absolute, or Net	Integration modes that can be selected
	OutputMode	Pulse or KYZ	Full pulse or KYZ (transition pulse)

Using the optional onboard digital inputs

Digital inputs are used for status monitoring or pulse counting applications. Status monitoring can help you prevent equipment damage, improve maintenance, or track security breaches. Common status monitoring applications include monitoring:

- ◆ closed/open positions of breakers.
- ◆ on/off status of generators.
- ◆ armed/unarmed conditions in a building alarm system.
- ◆ over/under pressures of transformers.

The function of each status input is controlled by a Digital Input module; this module tells the meter how to interpret incoming signals. Digital Input modules can be linked with other modules for counting status changes.

CAUTION

VOLTAGES OVER 130 VDC CAN DAMAGE DIGITAL INPUTS

Do not use digital inputs for voltage sensing applications.

Failure to follow this instructions can result in equipment damage.

For detailed information and instructions on configuring these modules, see the *ION Reference*. For information on the default settings for the modules, see the *ION Device Template Reference*.

The available settings in the Digital Input modules are as follows:

Setup register	Available settings	Description
Input Mode	Pulse, KYZ	Specifies complete pulse or KYZ transition pulse
EvLog Mode	Log On, Log Off	Specifies whether or not to log status changes. Digital Input status changes have an event priority of 20.
Debounce	numeric	Setting for the mechanical contact bounce, in seconds
Polarity	<i>Fixed at</i> NON-INVERTING	Specifies a non-inverted (or level) pulse
Port	I/O MODULE IN1 to I/O MODULE IN 8, NOT USED I/O Exp In 1 to 8 On-Board FormA 1 to 3	Specifies which hardware port the module controls

Using the optional analog outputs

Analog outputs let you output real-time power to an RTU or perform equipment control operations. The analog outputs provide industry standard 0 to 20 mA current signals. These outputs are only available with the optional I/O Expander.

⚠ WARNING

HAZARD OF UNINTENDED OPERATION

Do not use the meter for critical control or protection applications where human or equipment safety relies on the operation of the control circuit.

The electrical signal on the output is DC. Make sure proper polarity is observed when wiring external devices to the analog output ports.

Failure to follow these instructions can result in death, serious injury or equipment damage.

Four Analog Output modules control the optional I/O Expander's analog outputs. These modules are not linked by default. Link the numeric output of another ION module to the *Source* input of the Analog Output module—this value is represented

on the I/O Expander's analog output port. Setup the *Zero Scale* and *Full Scale* setup registers of the Analog Output module to the numeric range you want to emulate.

For detailed information and instructions on configuring these modules, see the *ION Reference*. For information on the default settings for the modules, see the *ION Device Template Reference*.

The available settings in the Analog Output module is as follows:

Setup registers	Available settings	Description
Port	I/O EXP AnOut 1 to I/O EXP AnOut 4, NOT USED	Specifies the output hardware channel.
Full Scale	-1×10^9 to 1×10^9	Sets the measured value that will create the maximum possible output on the analog output hardware port.
Zero Scale	-1×10^9 to 1×10^9	Sets the measured value that will create the minimum possible output on the analog output hardware port.

Ensure that the module's *Port* setup register matches the I/O Expander's output that you want to control. If the port you want to use does not appear in the *Port* setup register list, that port is in use by another module. Edit the *Port* setup register of the module using that port and set it to NOT USED – the port is then available to other modules.

See the *I/O Expander Installation Guide* for more information on the I/O Expander and the *ION Reference* for more information on the Analog Output module, including details are setting the zero and full scales. Both documents are available from www.schneider-electric.com.

Configuring inputs and outputs

Use ION Enterprise or ION Setup to configure the meter's I/O framework.

Using the front panel

You cannot configure I/O using the meter's front panel.

Using ION Setup

The Setup Assistant helps you configure your meter's optional (onboard and I/O Expander) analog and digital inputs and outputs.



NOTE

See "Energy pulsing" on page 141 for information on configuring the Calibration Pulsar modules in ION Setup.

In ION Setup:

1. Open the Setup Assistant for your meter. See the ION Setup Help for instructions.
2. Select either the **Onboard I/O** or the **Expander I/O** folder and select the screen for the I/O type that you want to configure.

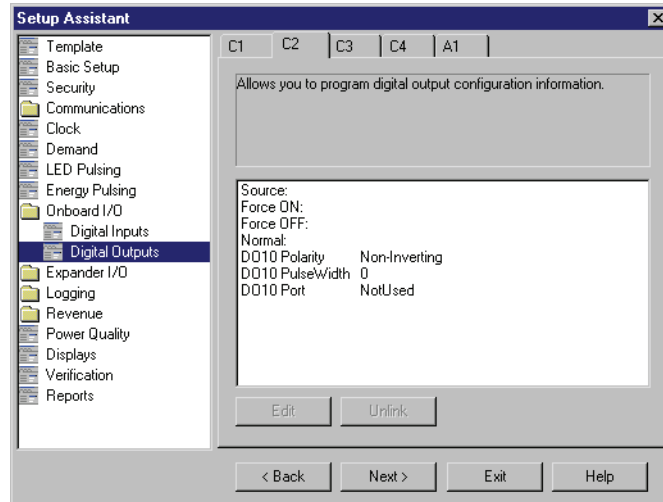

The tabs on the I/O screens correspond to the associated modules (for example, **Onboard I/O > Digital Outputs > A1** allows you to configure Digital Output module RA-1). Click the tab you want to edit.

3. Select the parameter and click **Edit** to edit a value.
4. Select Source and click **Edit** to link a module to a source. Navigate to the source register you require and click **OK**.

Using Designer

Open your meter in Designer and navigate to the Advanced Setup framework. Click on the appropriate grouping object (Digital Inputs, Digital Outputs or Analog I/O) and right-click the module that you want to edit.

Chapter 12 Energy pulsing

This chapter provides instructions for configuring energy pulsing on your meter.

In this chapter

- ◆ **Introduction** 142
- ◆ **Energy pulsing with LEDs** 143
- ◆ **Configuring energy pulsing** 144
 - Using the front panel 144
 - Using ION Setup 144
 - Using Designer 145
 - Calibration Pulser module settings 145
 - Pulser module settings 146

Introduction

Your meter uses Calibration Pulser modules and Pulser modules for energy pulsing.

- ◆ **Pulser module:** The Pulser module serves as an intermediary between other modules' pulse output registers (accepting them as pulse inputs) and a hardware output channel on the device. These modules are capable of sending pulses or pulse transitions to any hardware output channel.
- ◆ **Calibration Pulser module:** The Calibration Pulser module is a highly accurate energy pulser used for verifying accuracy on meters employed in billing applications. This module type serves as an intermediary between the power (kW, kVAR or kVA) outputs of the Power Meter module and a device's hardware output channel. Refer to the *PowerLogic ION8650 accuracy verification* technical note for instructions on verifying the accuracy of your meter. By default, two Calibration Pulser modules are configured and linked to the front panel LEDs.

See the *ION Reference* for more information on these modules.

Energy pulsing with LEDs

The two LEDs on the front panel are preconfigured for energy pulsing. The adjacent smaller infrared outputs are connected to the LEDs and pulse at the same rate.

The pulse rate of the LEDs can be adjusted by modifying the Kt setup register in the associated Calibration Pulser module. The value entered defines how much energy the module accumulates before a pulse is sent to the hardware channel. The front panel WATT and VAR LEDs are factory set to the same pulse rate. The Kt value is shown on your meter's front panel label; the default setting for Kt depends on the form factor of your meter.

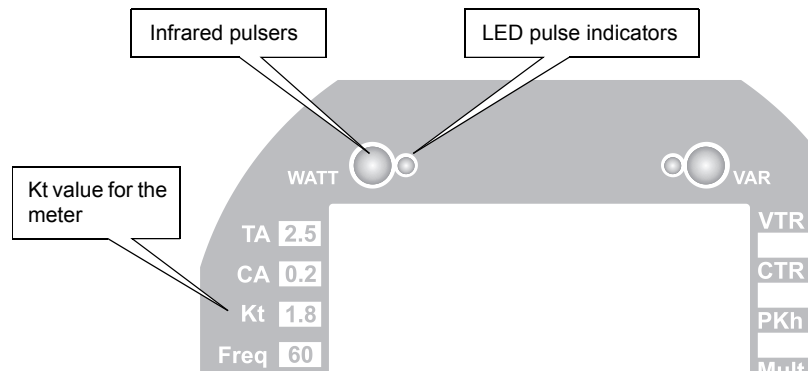

WATT – LED and VAR – LED

The WATT – LED is controlled by a Calibration Pulser module that has its *Source* input linked to the kW del+rec output of the Arithmetic module labeled “kW del, rec”.

The VAR – LED is controlled by a Calibration Pulser module that has its *Source* input linked to the kVAR del+rec output of the Arithmetic module labeled “kVAR del, rec”.

- ◆ For meters with 9S, 36S and 29S form factors, the default pulse rate of the front panel WATT LED is 1.8 (1.8 Watt-hours per pulse). The kt value of the VAR LED is also 1.8.
- ◆ For Form Factor 35S meters, the default pulse rate of the front panel WATT LED is set at 1.2 (1.2 Watt-hours per pulse). The Kt value for the VAR LED is also 1.2.

Customizing energy pulsing

Changing the value for the Kt setup register of the associated Calibration Pulser module lets you modify the pulsing rate of either channel. If you want to configure the LED port for a different pulsing application, you must re-link the *Source* input to the output register of a different instantaneous power quantity in one of the Arithmetic modules. Ensure that the quantity you select originates from the MU (meter units) Power Meter module.

Configuring energy pulsing

Use ION Enterprise or ION Setup to change your meter's energy pulsing settings.

⚠ WARNING

HAZARD OF UNEXPECTED DIGITAL OUTPUT PULSE

- Do not use the meter for critical control or protection applications where human or equipment safety relies on the operation of the control circuit.
- Be aware that an unexpected pulse on the digital outputs can result when the supply power to the meter is interrupted or after a meter firmware or template upgrade.

Failure to follow these instructions can result in death, serious injury or equipment damage.

Using the front panel

You cannot configure energy pulsing using the front panel.

Using ION Setup

In ION Setup:

1. Open the Setup Assistant for your meter. See the ION Setup Help for instructions.
2. Select **LED Pulsing**.

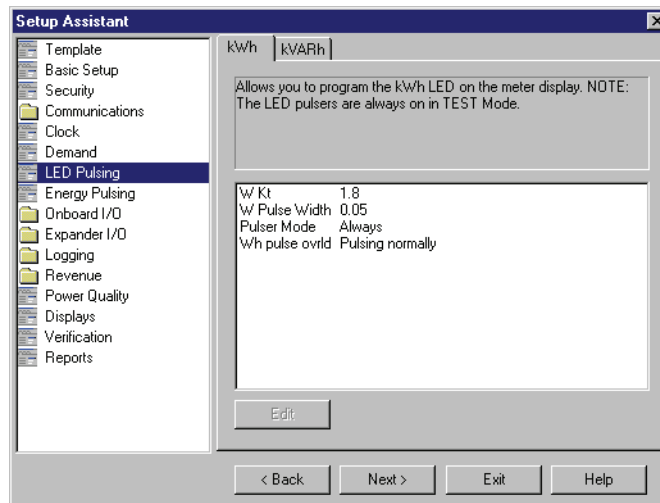

3. Click on the tab that corresponds to the LED that you want to configure.
4. Configure the settings as required. See “Calibration Pulser module settings” on page 145 for more information on the settings other than Pulser Mode.

Pulser Mode determines whether the LED pulsing occurs always or only when the meter is in TEST mode.

The appropriate Kt value depends on Scaled Rev Param (located on the Basic Setup tab).

- ◆ If *Scaled Rev Param* is OFF, the Kt value must be the primary value and the Calibration Pulser module pulses based on primary kWh and kVARh
 - ◆ If *Scaled Rev Param* is ON, the Kt value must be the secondary value, and the Calibration Pulser module pulses based on secondary kWh and kVARh.
5. Select the **Energy Pulsing** screen to configure the other default Calibration Pulser modules for energy pulsing applications, if required. By default, these modules are not linked to an output.
 6. Click the **End of Interval** tab to configure the end of energy pulsing.

Using Designer

Open your meter in Designer and navigate to the Energy Pulsing Setup folder. Right-click a module to edit.

Calibration Pulser module settings

The setup registers available in the Calibration Pulser module are listed in the table below. The defaults listed are for the two pre-configured Calibration Pulser modules that control the front panel LEDs (these modules are labelled Wh Pulse LED and VARh Pulse LED).

Setup register	Function	Default
Pulse Width	This register specifies the width of the pulses sent to the hardware channel (in seconds). The Calibration Pulser module maintains a minimum duty cycle of 50% on the output pulse train.	0.05
Kt	The numeric bounded register defines how much energy the module accumulates before a pulse is sent to the hardware channel. An industry standard for energy pulsing is 1.8, or one pulse per 1.8 energy-hours.	varies ¹
Int Mode	Specifies the modes of integration that can be selected.	Absolute
OutputMode	This register specifies whether the output is a complete pulse (Pulse) or a change of state transition (KYZ).	Pulse
Port	This register specifies which hardware port the pulse/KYZ transition appears on. Only those hardware channels that are still available appear in this list.	Not Used

¹ The default Kt value varies depending on the template. For meters with the 9S/29S/36S template, the default is 1.8. For meters with the 35S template, the default is 1.2.

Pulser module settings

Only the End of Interval Pulser module is available by default. The defaults below reflect the defaults in this module.

Setup register	Function	Default
Pulse Width	This register specifies the width of the pulses sent to the hardware channel (in seconds).	0.1
OutputMode	This register specifies whether the output is a complete pulse (Pulse) or a change of state transition (KYZ).	Pulse
Port	This register specifies which hardware port the pulse/KYZ transition appears on.	Not Used

Chapter 13 Logging

The ION8650 meter has powerful data logging and event recording capabilities. Data and event logs recorded by the meter are prioritized and stored onboard. Data is retrieved periodically by ION Enterprise (or another third party application).

If you use ION Enterprise, all retrieved data from your system is stored in an ODBC-compliant database. The information in the database can be viewed and analyzed using ION Enterprise components such as Vista (for viewing) or Web Reporter (for organizing and presenting data).

In this chapter

- ◆ **Data logging** **148**
 - Configuring data logging 148
 - Using the front panel 148
 - Using ION Setup 148
 - Changing waveform recording 150
 - The default logging framework 150
 - Default logging capacity 150
 - Changing the log depths 151
 - Changing the frequency of logging 151
 - Default logging configuration 151
 - Viewing data log information 155

- ◆ **Event logging** **156**
 - Event priority groups 156
 - Events external to the module 156
 - Displaying events 157

- ◆ **Logging and recording capacity** **158**

Data logging

The meter has a default, comprehensive data-logging configuration. Information regarding the default logging capacity and default logging configuration can be found in “Default logging capacity” on page 150.

To learn more about the Data Recorder modules in your meter, refer to the *ION Reference*.

Configuring data logging

Use ION Enterprise or ION Setup to change your meter’s logging settings.

Using the front panel

You cannot configure logging using the front panel.

Using ION Setup

In ION Setup:

1. Open the Setup Assistant for your meter. See the ION Setup Help for instructions.
2. Select the **Logging** folder.

Use the Memory, Load Profile and Event Log screens to configure your logging settings.

Memory screen

1. Select the **Memory** screen to re-allocate meter memory.

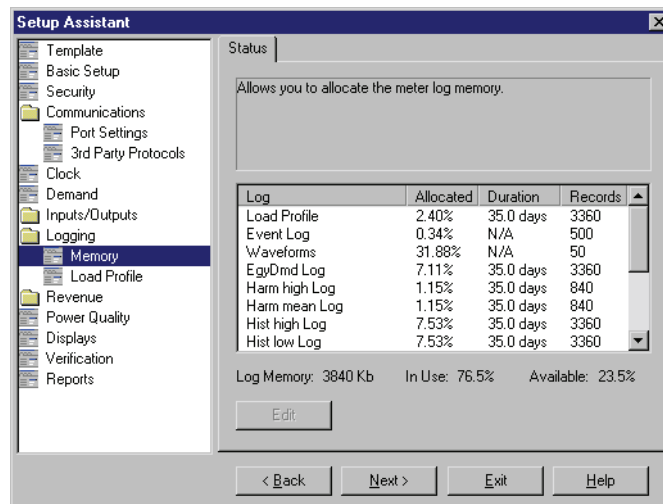

2. Select the log you want to configure and click **Edit**. You can change both the Log Duration (days) and the Log Size (records). Changing these parameters affects the meter memory allocated to that log.

Load Profile screen

1. Select the **Load Profile** screen to configure the Revenue Log.

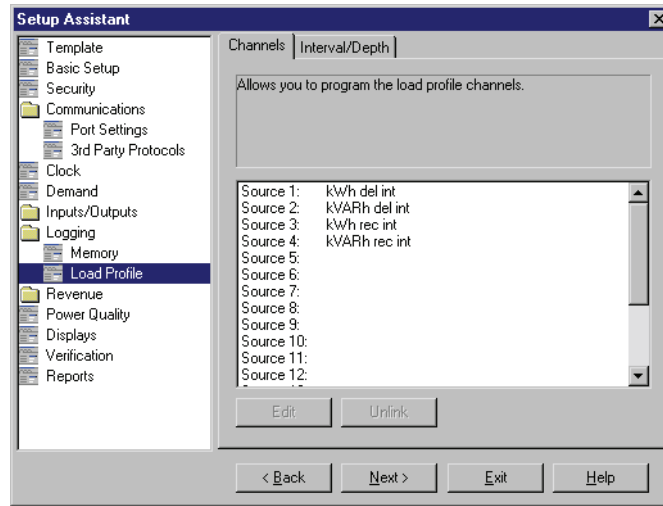

2. Click the **Channels** tab to access the Revenue Log sources. Select a source.
 - ◆ Click **Unlink** to unlink the parameter from the source.
 - ◆ Click **Edit** to edit the parameter. The **Parameter Selection** dialog box appears, showing source register groupings. Click on the '+' symbol beside the register group to view the individual registers. Select the register that you want to connect to the source and click **OK**.

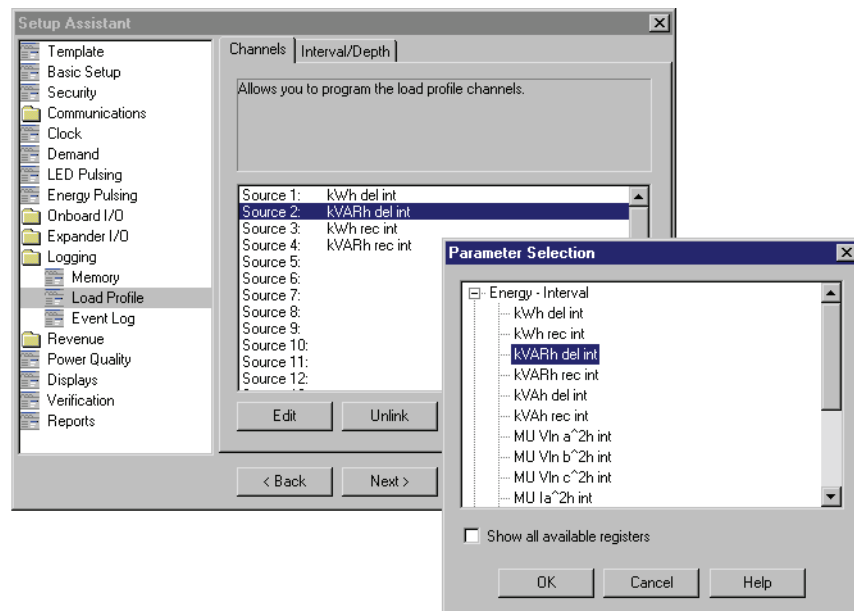

Select the **Show all available registers** checkbox for a complete list of all possible registers.

3. Click the **Interval/Depth** tab to edit the Revenue Log interval and duration and missing record handling.

Event Log screen

Select the **Event Log** screen to configure what events are logged:

- ◆ Cutoff: This parameter determines the minimum priority level for events to be logged; events with a lower priority are not logged.
- ◆ EvPriority: This parameter sets the event priority of Sag/Swell events. See “Configuring power quality event logging” on page 173 for more information.
- ◆ PhaseLossEnable: This parameter enables or disables phase loss event recording.

Changing waveform recording

The Waveform Recorder modules do not require changes to their default settings. If you want to change the format of the recorded waveforms, refer to the Waveform Recorder module description in the *ION Reference*.



NOTE

If you are generating COMTRADE waveform data records, the associated Waveform Recorder modules cannot be modified unless the COMTRADE module's *Module Enable* register is set to DISABLED. If the Waveform Recorder modules are not configured identically (have the same setup register values) the COMTRADE module will not go online.

The default logging framework

The following sections outline the default logging capacity and configuration.



NOTE

The default logging configuration may be used by other components of your power monitoring system (for example, the reporting components of ION Enterprise). Before you change the default configuration of any of the logs, ensure you understand the impact on the change on these components and the data they display.

Default logging capacity

The following table summarizes the default recording depths and recording intervals of the various Data recorders and Waveform recorders in the meter.

Log types		ION8650A default depth	ION8650B default depth	ION8650C default depth	Interval
Energy Logs	Revenue Log	9120	6240	3360	900 seconds
	Loss Log	9120	6240	N/A	900 seconds
	EgyDmd Log	9120	6240	N/A	900 seconds
Daily nominal log	DailyNom Log	450	450	N/A	Daily
Historic Logs	Hist Logs	9120	6240	N/A	900 seconds
Harmonic Logs	Harm Logs	2280	1560	N/A	3600

Log types		ION8650A default depth	ION8650B default depth	ION8650C default depth	Interval
Disturbance Recorders	Transient Log	3000	N/A	N/A	Triggered on demand
	Sag/Swell Log	3000	3000	3000	Triggered on demand
	SagSwellState Log	3000	3000	N/A	Triggered on demand
	COMTRADE ¹	1	N/A	N/A	Triggered by Waveform Recorder
EN50160 Logs (ION8650A and ION8650B only)	22 Data Recorders	Varies ²	Varies ²	N/A	Daily, weekly, 10 minutes... ²
4-30 Logs (ION8650A and ION8650B only)	3 Data Recorders	Varies ³	Varies ³	N/A	3 second, 10 minute, 2 hour

¹ See the *COMTRADE and ION Technology* technical note for more details.

² See the *Power Quality: ION Meters and EN50160* technical note for more details.

³ See the *4-30 Compliance and ION meters* technical note for more details.

Changing the log depths

Change the value in a Data Recorder module's *Depth* setup register to increase the number of records stored in the recorder. The *RecordMode* setup register controls how the Data Recorder overwrites old records; refer to the Data Recorder module description in the *ION Reference* before changing this setup register.

Changing the frequency of logging

The five Periodic Timer modules that control the frequency of different data recording are as follows:

- ◆ "Revenue Log Trg" controls the frequency of the logging of revenue values
- ◆ "Loss Log Trg" controls the frequency of Loss Compensation Data logging
- ◆ "EgyDmd Log Trg" controls the frequency of logging for the Energy and Demand Log (this log is used for generating reports using Web Reporter)
- ◆ "Hist Log Trg" controls the frequency of Historic Data logging
- ◆ "Harm Log Trg" controls the frequency of Harmonics logging



NOTE

Programming your meter to write to any data recorder at continuous intervals lower than 60 seconds (heavy logging configuration) can cause loss of data in the event of a power failure. Use of an uninterruptible power supply (UPS) is recommended for such heavy logging configurations.

Change the value in the *Period* setup register to change the frequency of data logging (in seconds). Do not change the *Sync Mode* setup register.

Default logging configuration

The following sections describe each Data Recorder module and the parameters they log. Your meter may not have all of the logs described and the settings may vary depending on the meter, its firmware and its template.

Revenue logging

The *Revenue Log* is configured for use with UTS MV-90 billing software. The default values logged by the Revenue Log are as follows:

Parameter	Description
kWh del int	Interval kWh delivered
kWh rec int	Interval kWh received
kVARh del int	Interval kVARh delivered
kVARh rec int	Interval kVARh received

Historic data logging

Three data recorders are used to record standard power system quantities, such as phase current, phase voltage and power factor. By default, they log the following output register values:

Hist Mean Log	
VII ab mean	I avg mean
VII bc mean	kW tot mean
VII ca mean	KVAR tot mean
VII avg mean	kVA tot mean
V unbal mean	PF lag mean
Ia mean	PF lead mean
Ib mean	Freq mean
Ic mean	

Hist High Log	
VII ab high	I avg high
VII bc high	kW tot high
VII ca high	KVAR tot high
VII avg high	kVA tot high
V unbal high	PF lag high
Ia high	PF lead high
Ib high	Freq high
Ic high	

Hist Low Log	
VII ab low	I avg low
VII bc low	kW tot low
VII ca low	KVAR tot low
VII avg low	kVA tot low
V unbal low	PF lag low
Ia low	PF lead low
Ib low	Freq low
Ic low	

Loss Log

One *Loss Log* recorder is configured to record loss values. By default, it logs the following parameters – note that the parameters differ depending on the meter template:

Template	Loss Log parameter	Description
All	MU Ia ² h int	Phase A interval current squared hours
All	MU Ib ² h int	Phase B interval current squared hours
All	MU Ic ² h int	Phase C interval current squared hours
35S only	MU VII ab ² h int	Phase A interval voltage Line-to-Line squared hours
35S only	MU VII bc ² h int	Phase B interval voltage Line-to-Line squared hours
35S only	MU VII ca ² h int	Phase C interval voltage Line-to-Line squared hours
9S/29S/36S only	MU VI _n a ² h int	Phase A interval voltage Line-to-Neutral squared hours
9S/29S/36S only	MU VI _n b ² h int	Phase B interval voltage Line-to-Neutral squared hours
9S/29S/36S only	MU VI _n c ² h int	Phase C interval voltage Line-to-Neutral squared hours

Harmonics logging

Two recorders provide various harmonics logs, including K-factor and Total Harmonics Distortion (THD). These recorders are labeled *Harm Mean Log* and *Harm High Log*. By default, they log the following values:

Harm Mean log		Harm High log	
V1 THD mean	I1 K Fac mean	V1 THD high	I1 K Fac high
V2 THD mean	I2 K Fac mean	V2 THD high	I2 K Fac high
V3 THD mean	I3 K Fac mean	V3 THD high	I3 K Fac high
I1 THD mean		I1 THD high	
I2 THD mean		I2 THD high	
I3 THD mean		I3 THD high	

Energy Demand Log

One data recorder is configured to provide power system data for the Web Reporter component of ION Enterprise.

EgyDmd Log	
kWh del	kVAh del+rec
kWh rec	kW sd del-rec
kWh del-rec	kVAR sd del-rec
kVARh del	kVA sd del+rec
kVARh rec	PF lag mean
kVARh del-rec	PF lead mean

Sag/Swell and Transient logging

Three data recorders provide details of these power quality events. The Sag/Swell and Transient data recorders, by default, log the following values

Sag/Swell log (ION8650A and ION8650B)			
DistDur	DistV1Engy	DistV2Engy	DistV3Engy
DistV1Min	DistV2Min	DistV3Min	DistNominal
DistV1Max	DistV2Max	DistV3Max	SwellLim
DistV1Avg	DistV2Avg	DistV3Avg	SagLim
Sag/Swell log (ION8650C)			
DistDur	DistV2Max	PT Prim	
DistV1Min	DistV3Min	PT Sec	
DistV1Max	DistV3Max	CT Prim	
DistV2Min	DistNominal	CT Sec	

Transient log			
TranV1Dur	TranV2Max	TranNominal	PT Sec
TranV1Max	TranV3Dur	Threshold	CT Prim
TranV2Dur	TranV3Max	PT Prim	CT Sec

The SagSwellState data recorder provides additional information required by the Sag/Swell and Transient logs.

See “Configuring power quality event logging” on page 173 for enabling or disabling Sag/Swell and Transient events from being recorded in the Event Log.



NOTE

Modification of the Sag/Swell, Transient and SagSwellState logs is an advanced procedure that should only be performed by experienced users familiar with ION and the interaction of these data recorders.

See the *COMTRADE and ION Technology* technical note for information about COMTRADE records.

EN50160 compliance logging (ION8650A and ION8650B only)

By default, 22 Data Recorder modules are used for logging EN50160 compliance parameters.

Data Recorder	EN50160 component logged
EN50160 Frq/Mg	Power Frequency and Supply Magnitude
EN50160 Flicker	Flicker
EN50160 Vlt Dp1	Supply Voltage Dips
EN50160 Vlt Dp2	
EN50160 Vlt Dp3	
EN50160 Vlt Dp4	
EN50160 Vlt Dp5	
EN50160 Intrp	Short/Long Interruptions
EN50160 OvrVlt1	Temporary Overvoltages
EN50160 OvrVlt2	
EN50160 OvrVlt3	

Data Recorder	EN50160 component logged
EN50160 Vunbal	Voltage Unbalance
EN50160 Hrm Vlt	Harmonics (up to 40th)
EN50160 Ihm Vlt	
EN50160 MSignal	Mains Signalling Voltage
EN50160 Prm-f/V	Parameter data These data recorders are disabled by default (see below).
EN50160 Prm-Flk	
EN50160 Prm-VDp	
EN50160 Prm-Vlr	
EN50160 Prm-OV	
EN50160 PrmHrm1	
EN50160 PrmHrm2	

The meter logs EN50160 counter data for present and previous observation periods as well as EN50160 events. EN50160 parameter data logging (from seven “Prm” data recorders) is disabled by default. Enable or disable EN50160 Parameter Logging via the default Power Quality Vista diagram.

For more information about EN50160 data logging, see the *Power Quality: ION Meters and EN50160* technical note.

4-30 logging (ION8650A and ION8650B only)

Three data recorders are used to log parameters related to 4-30 compliance and to create reports.

Data Recorder	4-30 parameters logged
4-30 3s Log	<ul style="list-style-type: none"> ◆ Voltage Disturbances ◆ V1-RMS (Root-Mean-Square) ◆ V2-RMS ◆ V3-RMS ◆ THD (Total Harmonic Distortion) ◆ Vneg/Vpos ◆ Vzero/Vpos ◆ V-Overdeviation ◆ V-Underdeviation ◆ Frequency ◆ Flicker (deviation expressed as a percentage of nominal voltage; available in 10-minute and 2-hour reports only) ◆ Unbalance
4-30 10m Log	
4-30 2hr Log	

For more information on 4-30 compliance, see the *4-30 Compliance and ION meters* technical note.

Viewing data log information

Viewing data in ION Setup

In ION Setup:

1. Select your meter.
2. Select **View > Data Screens > Data Recorders**. The following logs are available for viewing, depending on your meter:
 - ◆ Average Harmonics
 - ◆ Energy & Demand
 - ◆ Historic Average, Historic Highs, Historic Lows
 - ◆ Maximum Harmonics
 - ◆ Revenue Log
 - ◆ Sags & Swells
 - ◆ Transformer Losses
 - ◆ Transients (ION8650A only)

See “Reports” on page 207 for information on running basic reports in ION Setup.

Viewing data in ION Enterprise

You can view information from the data logs in the Vista, WebReach and Web Reporter components of ION Enterprise. See the online ION Enterprise Help for more information.

Event logging

Events produced by the meter's various ION modules are prioritized and grouped to facilitate custom logging. Each event is assigned a priority group number based on its type and severity.

Event priority groups

Some event groups are preset with a priority number as shown in the table below. You can also define your own priority number for some modules. Priority numbers from 128-191 appear in the global event log viewer in the Vista component of ION Enterprise. Priority numbers from 192-255 are also logged, initiate a beep and cause the window to flash. You can customize these responses to display messages or perform *net send* messages, for example.

Event group	Description	Priority number
Reset	Module reset or re-synchronized	5
Setup Change	Module setup changes (setup register changes, label changes, input handle changes)	10
Input Register Change	Inputs of certain modules change value (for example, input to And/Or module changes)	15
I/O State Change	I/O state changes (for example, relay closes)	20
Information	Module produces important user information	25
Warning	Module produces a warning	30
EN50160 Event (ION8650A and ION8650B only)	An EN50160 counter (N_1 or N_2) increases	50
Loss of Potential	Loss of Potential has occurred	128
Error Detected	An error has been detected	255
Setpoint	Setpoint condition goes Active or Inactive (for example, Sag/Swell module detects a disturbance)	programmable via module setup

The Event Log Controller module allows you to set a priority cutoff for event logging. Any events with a priority number greater than the cutoff value are logged, and events with lower priorities are discarded. Refer to the individual module descriptions and the Event Log Controller module description in the *ION Reference* for more details.

Events external to the module

Some events are not produced by a specific module. These events are generated internally by the meter. Their associated priority levels are shown in the table below.

Event group	Description	Priority number
Warning	Factory initialize performed	30
	Firmware or memory upgrade performed	
	Meter power-up or power-down	
	Internal modem not responding or modem recovered	
	Battery low	
	Telnet or serial terminal locked out	
	Security disabled or enabled	
Failure	Communications not able to allocate required memory	255

Displaying events

View events in the following locations:

Application	Menu / screen	Navigation
Front Panel	Event Log	ALT display mode
ION Setup	Event Log	Setup Assistant > Reports > Event Log
Vista	Meter Events	Volts/Amps tab > Meter events object

Logging and recording capacity

The meter provides both data and event logs. The amount of memory required to store these logs depends on the number of parameters being logged and the frequency with which these parameters are logged.

The following equation can help determine the amount of memory required to store **data and event logs**:

$$\text{each record consumes (in Bytes)} = [(\text{number of parameters} * 5) + 8]$$

The meter can also perform waveform recording. To calculate the **waveform memory** usage use the following formula:

$$\text{waveform memory usage (in Bytes)} = [2 * (\text{number of samples per cycle} + 10) * (\text{number of cycles in waveform}) + 30]$$



NOTE

Round up to the nearest kilobyte after each of the above calculations.

In ION Setup, the Memory tab in the Logging folder of the Setup Assistant displays the memory allocated to each log and the meter's total in-use and available logging memory.

Chapter 14 Revenue

This chapter provides instructions for configuring PT/CT correction, transformer line loss compensation and time of use.

In this chapter

- ◆ **PT/CT correction** **160**
 - Configuring PT/CT correction 160

- ◆ **Transformer Line Loss Compensation** **162**
 - Configuring TLC 162
 - Using the front panel 162
 - Using ION Setup 162
 - Using Vista 163

- ◆ **Time of Use** **165**
 - Configuring Time of Use 165
 - Using the front panel 165
 - Using ION Setup 165
 - Time Of Use settings 166
 - Seasonal settings 166
 - Time of Use module settings 166
 - Displaying Time of Use 167

PT/CT correction

The primary application for PT/CT correction is to apply correction factors for ratio errors and phase angle errors to instrument transformers. Instrument transformer correction reduces or eliminates the need to replace transformers in installations where high accuracy is required.

PT/CT correction is done using the Instrument Transformer Correction (*Instr Xformer*) module. There is an ITC module for each current input (I1, I2, I3) and for each voltage input (V1, V2, V3) to the meter. Note that the correction affects only the 1-second values in the Power Meter module. No high-speed, harmonics, or waveform values are affected by the correction. For more information, see the ITC (*Instr Xformer*) module description in the *ION Reference*.

Configuring PT/CT correction

In ION Setup:

1. Open the Setup Assistant for your meter. See the ION Setup Help for instructions.
2. Select **Revenue > PT/CT Correction**.
3. Select Active Correction on the ITC Correction tab then click **Edit**. The Transformer Correction Setup wizard appears.

Transformer Correction Setup

Specify amount of provided information

Enter the number of test points that ratio correction factors and phase angle errors will be specified for each input. Also enter the nominal secondary voltage/current rating for each type of instrument transformer.

Voltage Inputs

V1 V2 V3 Nominal

Current Inputs

I1 I2 I3 Nominal

< Back Finish Cancel Help

4. Select the checkbox beside the Voltage Inputs or Current Inputs and click **Next**. The first correction screen appears.

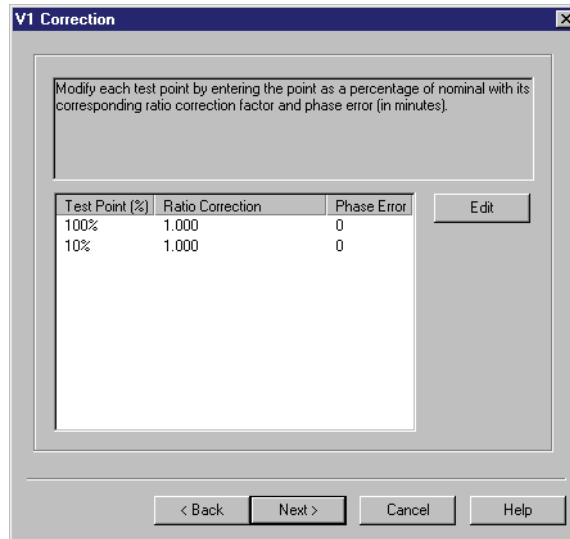

5. Select a test point and click **Edit** to edit the test points. Click **OK** to return to the correction wizard then click **Next** to move to the next correction screen. Go through all the correction screens then click **Finish**.

**NOTE**

You can select a maximum of eight (8) test points.

6. Select Active Correction on the ITC Correction tab and click **Analyze** to access screens where you can input your wiring configuration and power system information.

Transformer Line Loss Compensation

Transformer Loss Compensation (TLC) is used when a meter's actual location is different from the electrical location where change of ownership occurs; for example, where meters are connected on the low-voltage side of power transformers when the ownership change occurs on the high-side of the transformer. This physical separation between meter and actual billing point results in measurable losses. Compensating for this loss - Loss Compensation - is the means of correcting this meter reading. Losses may be added to or subtracted from the meter registration.

Meters are usually installed on the low-voltage side of a transformer because it is more cost-effective. There are also cases where change of ownership can occur halfway along a transmission line where it is impractical to install a meter. In this case, power metering must again be compensated.



NOTE

Due to the variation in installations, **advanced knowledge of power systems and connection methods is required before transformer loss compensation can be properly implemented.** Data parameters should only be programmed by qualified personnel that have appropriate training and experience with Transformer Loss Compensation calculations.

For more information, see the *Transformer Line Loss Calculations* technical note.

Configuring TLC

Use ION Enterprise or ION Setup to change your meter's TLC settings.

Using the front panel

You cannot configure Transformer Line Loss Compensation using the front panel.

Using ION Setup

The Transformer Loss screen allows you to enable/disable TLC, choose which method you prefer (1 or 2) and configure TLC settings.

In ION Setup:

1. Open the Setup Assistant for your meter. See the ION Setup Help for instructions.
2. Select **Revenue > Transformer Loss**. Click the **Method Selection** tab.
3. Select **Loss Comp Enable** to enable TLC, then click **Edit**.

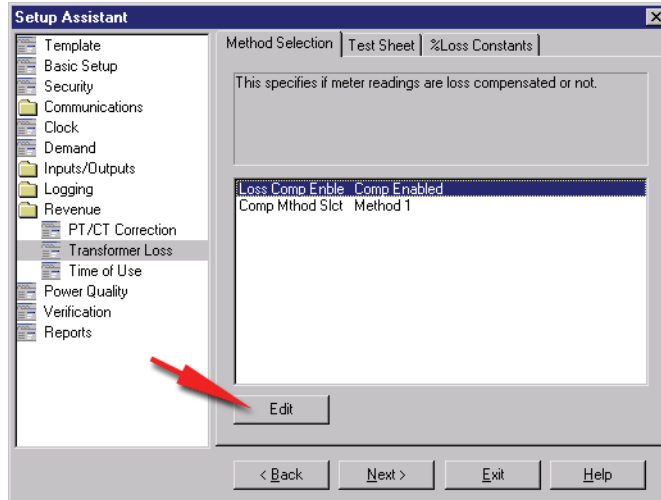

4. Select **Comp Enabled** from the dropdown list and click **OK**.
5. Select **Comp Mthod Slct** and click **Edit** to choose the TLC method you want to use. Select **Method 1** to use the Test Sheet method and **Method 2** to use the %Loss Constants method.
Click **OK**.
6. Click the tab of the TLC method you chose in the previous step and configure the settings for that method.

Using Vista

1. Open your meter in Vista.
2. Click the **Revenue** tab.

- Click the **Loss Compensation** object. The **Loss Compensation** window appears:

The screenshot shows the 'Loss Compensation' configuration window for 'Victoria.SWB8650A'. It features a 'Loss Compensation Mode' section with 'Enabled' selected. The 'Loss Compensation Method' section has 'Method 1 ("Test Sheet Method")' selected. The window is divided into two main sections: 'Method 1 ("Test Sheet Method")' and 'Method 2 ("%Loss Constants Method")'. Callouts provide instructions: 'Click here to enable Loss Compensation calculations.' points to the 'Enabled' radio button; 'Choose either the Test Sheet or %Loss Constants compensation method.' points to the 'Method 1' and 'Method 2' radio buttons; and 'These are the true instrument transformer ratios. Normally they coincide with the Power Meter module's setup.' points to the 'PT ratio' and 'CT ratio' input fields.

Loss Compensation Mode
 If Loss Compensation is enabled, all billing parameters are compensated.
 Disabled
 Enabled

Loss Compensation Method
 Method 1 ("Test Sheet Method")
 Method 2 ("%Loss Constants Method")

Method 1 ("Test Sheet Method")
 Supply Side Line Load Side Line
 Indicate if meter location is supply side or load side
 Indicate if meter location is transformer side or not
 Not Transformer Side Transformer Side

Instrument Transformer information
 PT ratio:
 CT ratio:
 Primary V/I rated:

Transformer Losses
 kVA rated:
 LWF_e (no-load):
 LWC_u (full-load):
 Power Transformer Ratio:
 % Excitation:
 % Impedance:

Supply Side Line Loss
 Line Length:
 Resistance/Unit Length:
 Reactance/Unit Length:

Load Side Line Loss
 Line Length:
 Resistance/Unit Length:
 Reactance/Unit Length:

Method 2 ("%Loss Constants Method")
Instrument Transformer Ratios (prim/sec)
 PT ratio:
 CT ratio:
Meter Information
 Rated Meter Voltage:
 1/2 Class Meter Amps:
 # Stator Elements:
Copper Loss Compensation
 Enabled
 Disabled
 %LWC_u:
 %LV_{Cu}:
Iron Loss Compensation
 Enabled
 Disabled
 %LWF_e:
 %LV_{Fe}:

- Configure your values as required.

See the *Transformer Line Loss Calculations* technical note for more details on this feature.

Time of Use

The Time of Use module may only be important if you are using the meter in a billing application (for example, you are a power provider), as the module contains the meter's seasonal rate schedules. Typically, power consumers do not require Time Of Use configuration.

See the *ION Reference* for more information on the Time of Use module.

Configuring Time of Use

Use ION Enterprise or ION Setup to change your meter's Time of Use settings.

Using the front panel

You cannot configure Time of Use using the front panel.

Using ION Setup

In ION Setup:

1. Open the Setup Assistant for your meter. See the ION Setup Help for instructions
2. Select **Revenue > Time of Use**.

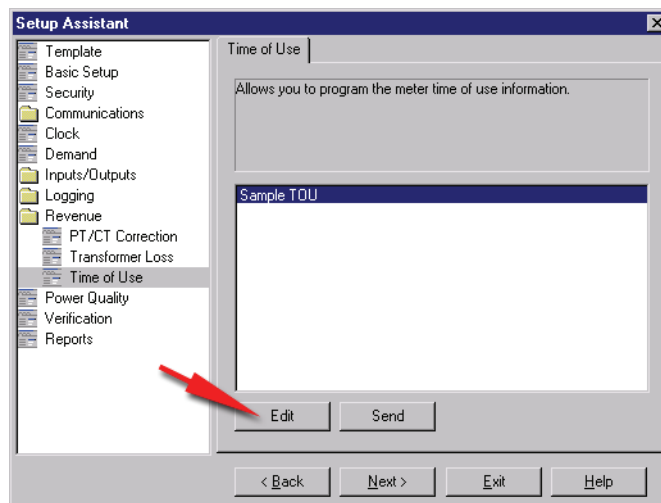

3. Select a Time of Use program from the list (for example, Sample TOU) and click **Edit**.
4. Follow the Time of Use Wizard to configure your program. Click **Send** to save the TOU program on your meter.

Time Of Use settings

The Time of Use module's setup registers define your seasons' start and end dates, the day types where your rates differ, and the rate schedules for each season's day types. The module compares the meter's internal clock with the season, day, and time of day settings in these registers and changes its output registers to reflect the current state of these settings.

Seasonal settings

The Time of Use module supports up to four separate seasons. Each seasons' start and end dates are set into the appropriate *Season* setup register.



NOTE

Ensure that there is no date overlapping when defining seasons and that every day of the year is covered by your seasons. If there are gaps between seasons, the module returns an exception message and will not function.

If your rates do not change between seasons, you do not need to configure the *Season* setup registers — by default, all Season 1 rates are in effect all year.

If you have different seasons, enter their start and end dates into the appropriate setup registers. If your season is active on the same dates every year, you only need to enter a single range of dates in the appropriate *Season* setup register. If the active dates are different each year (for example, Season 3 becomes active every first Monday in August), the start dates must be individually specified for each year.



NOTE

Changes to the TOU seasons are noted in the meter's event log.

Time of Use module settings

The Time of Use module is partially configured at the factory. Check the setup registers to ensure that the settings match your Time of Use schedules.

Setup register	Function
Season 1 - 4	These setup registers define the dates for each active season. When a season is active, the Time of Use module uses the applicable rate schedules.
Season 1 - 4 Weekday Rates	These setup registers specify seasonal weekday rates.
Season 1 - 4 Weekend Rates	These setup registers specify seasonal weekend rates.
Season 1 - 4 Alt 1 Rates	These setup registers specify a season's daily rates during the days specified in the Alt 1 Days setup register.
Season 1 - 4 Alt 2 Rates	These setup registers specify a season's daily rates during the days specified in the Alt 2 Days setup register.

Setup register	Function
Season 1 - 4 Holiday Rates	These setup registers specify a season's daily rates during the days specified in the Holidays setup register.
Weekdays	This register defines the days of the week for all seasons. The rates in the Season (1, 2, 3, or 4) Weekday Rates setup registers are used on these days.
Weekends	This register defines the weekend days for all seasons. The rates in the Season (1, 2, 3, or 4) Weekend Rates setup registers are used on these days.
Alt 1 Days	This register defines a set of alternative dates for all seasons. These dates generally have different rates from weekdays, weekends, or holidays.
Alt 2 Days	This register is similar in function to Alt 1 Days, but contains a different set of dates.
Holidays	This register defines the holidays for all seasons. The rates defined in the Season (1, 2, 3, or 4) Holiday Rates setup registers are used on these days.
Self Read Days	This setup register defines the dates and times that the <i>Self Read</i> output register pulses. If no time is entered in this register, the <i>Self Read</i> output register pulses on the date specified at 12:00 AM.

Displaying Time of Use

View Time of Use values in the following locations:

Application	Menu	Navigation
Front Panel	Active TOU Rate and Active TOU Season screens	ALT Display mode
Vista	Time of Use Screen	Revenue tab > Time of use object

Chapter 15 Power quality

This chapter explains how to configure your meter’s power quality functionality.



NOTE

To help ensure meter accuracy:
Your meter must have adequate power; for power quality applications with inadequate line power, an auxiliary power supply for the meter is recommended.
Your meter must have a properly connected protective earth ground since insufficient earth grounding of the meter can adversely affect meter accuracy.

In this chapter

- ◆ **Power quality configuration** 170
 - Configuring power quality settings 170
 - Using the front panel 170
 - Using ION Setup 170
 - Using Designer 171
 - Sag/Swell module settings 171
 - Transient module settings (ION8650A only) 172
 - Configuring power quality event logging 173
 - Using the front panel 173
 - Using ION Setup 173
 - Using Designer 173
 - Power quality standards compliance 174
 - EN50160 settings (ION8650A and ION8650B) 174
 - 4-30 settings (ION8650A and ION8650B only) 174
 - COMTRADE settings 174

Power quality configuration

Power quality configuration is provided by a number of modules and frameworks, depending on your meter type, such as the Sag/Swell module, the Transient module, the Mains Signalling Evaluation module, and the IEC 61000-4-30 framework, among others.

See the *ION Reference* for more information on these modules.

For a description of the scaled operational values (SOV) feature and the alternate scaling registers on the Power Quality page in the Vista component of ION Enterprise, refer to “Scaled operational values” on page 70.

Configuring power quality settings

Use ION Enterprise or ION Setup to change your meter’s power quality settings.



NOTE

The Sag/Swell module’s *Nom Volts* setting is used by the Transient module, as well as in other power quality features such as EN50160 and 4-30 calculations. You must set this register to enable these power quality features. If the Sag/Swell module’s *Nom Volts* setup register is set to zero, these functions are disabled. *Nom Volts* is typically set when the meter is put into service. If *Nom Volts* has not been set, enter a value for your system’s nominal voltage (i.e., 120, 277, or 347).

Using the front panel

You cannot configure power quality from the front panel.

Using ION Setup



NOTE

COMTRADE must be DISABLED in order to configure Sag/Swell or Transients.

In ION Setup:

1. Open the Setup Assistant for your meter. See the ION Setup Help for instructions.
2. Select the **Power Quality** screen.

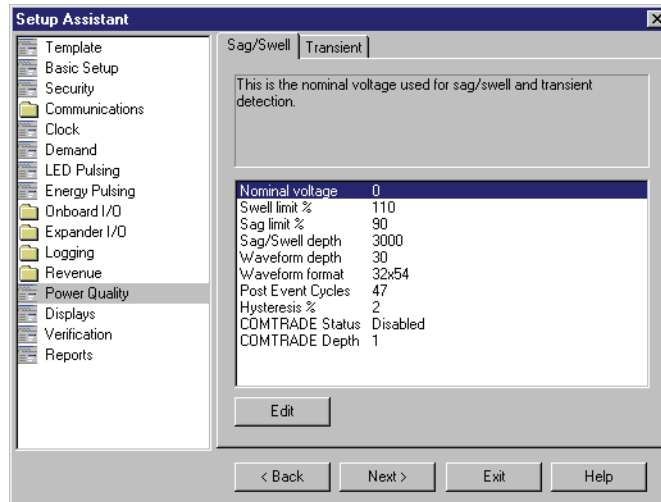

3. Set COMTRADE Status to Disabled, if it is enabled.
4. Click the **Sag/Swell** tab to record your system's nominal voltage, set sag and swell limits, configure sag/swell waveform recorder settings, enable COMTRADE waveform records and set other sag/swell settings.



NOTE

The Sag/Swell module's Nom Volts setting is used by the Transient module, as well as in other power quality features such as EN50160 and 4-30 calculations. All power quality functions are disabled if the nominal voltage is set to 0 (zero).

5. Click the **Transient** tab to set the voltage deviation threshold, set the transient waveform recorder depth and frequency, enable COMTRADE waveform records and set other transient settings.



NOTE

The ION8650A features dual waveform capture: Sags are recorded at 32 samples x 54 cycles. Transients waveform capture at 512 samples x 4 cycles.

6. Re-enable COMTRADE, if necessary.

Using Designer

Open your meter in Designer and navigate to the Power Quality folder. Right-click a module to edit.

Sag/Swell module settings

The Sag/Swell module monitors voltage waveforms for sags and swells (i.e., ITI [CBEMA] Type 2 and Type 3 disturbances). It then reports each disturbance's magnitude and duration. The Sag/Swell module can also detect sub-disturbances during a Sag/Swell event. Settings are as follows:

Setup register	Function	Default
Swell Lim	This is the magnitude above which a voltage deviation is considered a swell.	110
Sag Lim	This is the magnitude below which a voltage deviation is considered a sag.	90
Change Crit	This is the amount a voltage signal must change during a disturbance to be considered a new sub-disturbance.	10
Nom Volts ¹	This is the nominal power system voltage (used for all power quality functions). Set Nom Volts to 0 (zero) to disable power quality monitoring.	0
Hysteresis	This is the difference in magnitude between the start and end limits for a Sag/Swell. For example, if the sag limit is set to 90% and the hysteresis is set to 2%, the voltage needs to reach 92% before the sag is considered over.	2
EvPriority	The priority assigned to Sag/Swell module events (0 to 255, 255 is highest).	0

¹ The primary power system voltage is sometimes different than the PT Primary setup register value (for example, when the PT Primary is used to indicate winding ratio rather than primary voltage).

You also need to set the *EvPriority* register value if you want Sag/Swell events to be recorded in the Event Log. To enable Sag/Swell events, the *EvPriority* value must be greater than the Event Log Controller module's *Cutoff* value (the recommended Sag/Swell *EvPriority* value is 200). To disable Sag/Swell events so they are not recorded in the Event Log, set *EvPriority* to 0 (zero).

You can change *Swell Lim* and *Sag Lim*, but most applications are served by the default values entered into these registers. The *Change Crit* setup register does not need to be changed for normal operation.

Transient module settings (ION8650A only)

The Transient module monitors voltage waveforms for transient activity (i.e. ITI [CBEMA] Type 1 disturbances). The *Threshold* setup register defines what voltage disturbance magnitude is considered as transient activity. *Threshold* is interpreted as a percentage of the nominal system voltage, plus 100. For example, if you want transients recorded when voltage deviates from nominal by 20%, enter 120 into the *Threshold* setup register.

Setup register	Function	Default
Threshold	This is the magnitude at which a voltage deviation is considered a transient.	125
EvPriority ¹	The priority assigned Transient module events (0 to 255, 255 is highest).	0

¹ By default, Transient events are not recorded in the Event Log.

You also need to set the *EvPriority* register value if you want Transient events to be recorded in the Event Log. To enable Transient events, the *EvPriority* value must be greater than the Event Log Controller module's *Cutoff* value (the recommended Transient *EvPriority* value is 200). To disable Transient events so they are not recorded in the Event Log, set *EvPriority* to 0 (zero).

Configuring power quality event logging

Use ION Enterprise or ION Setup to change your meter's power quality event log settings.



NOTE

By default, Power Quality events are not included in the Event Log.

Using the front panel

You cannot configure Power Quality event logging from the front panel.

Using ION Setup

In ION Setup:

1. Open the Setup Assistant for your meter. See the ION Setup Help for instructions.
2. Select **Logging > Event Log**.
3. Select Sag/Swell Event Priority (*SS1 EvPriority*) or Transient Event Priority (*TR1 EvPriority*) on the Event tab and click **Edit**.

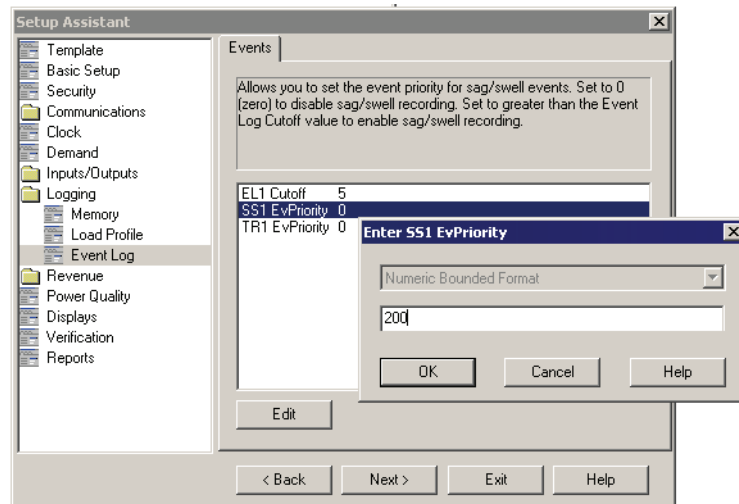

- ◆ To stop Sag/Swell or Transient events from being recorded in the Event Log, set event priority to zero (0).
- ◆ To include Sag/Swell or Transient events in the Event Log, the event priority must be greater than the Event Log Cutoff (*EL1 Cutoff*) value. The recommended *EvPriority* value for enabling event logging is 200.

Using Designer

Open your meter in Designer and navigate to the Power Quality Setup Framework. Right-click the Sag/Swell or Transient module to edit.

Power quality standards compliance

The ION8650 has additional frameworks and settings related to the power quality standards below.

EN50160 settings (ION8650A and ION8650B)

The EN50160 framework is composed of numerous ION modules including: Mains Signaling Evaluation, Harmonics Evaluation, Voltage Harmonics, Flicker, and more.



NOTE

To avoid missing data in your EN50160 reports, use a meter with an auxiliary power option connected to a UPS (Uninterruptible Power Supply) so that the EN50160 framework continues to operate during power outage situations.

See “EN50160 compliance logging (ION8650A and ION8650B only)” on page 154 for information on EN50160 parameter logging.

See the *Power Quality: ION Meters and EN50160* technical note for details.

4-30 settings (ION8650A and ION8650B only)

IEC 61000-4-30 power quality standard compliance is provided by a variety of ION modules including: Power Quality Aggregator, Harmonics Measurement, Disturbance Analyzer, Symmetrical Components, Mains Signaling Evaluation, Sag/Swell and more.

See the *4-30 Compliance and ION Meters* technical note for details.

COMTRADE settings (ION8650A and ION8650B only)

The meter can provide waveforms in COMMon format for TRAnsient Data Exchange (COMTRADE) format. COMTRADE records are created from the existing Waveform Recorder modules, which are connected to the COMTRADE module.

See the *COMTRADE and ION Technology* technical note for details.

Chapter 16 Displays

This chapter explains the available front panel displays. It also includes procedures for customizing displays using ION Enterprise or ION Setup.

In this chapter

- ◆ **Introduction** 176
- ◆ **Configuring front panel displays** 177
 - Using the front panel 177
 - Using ION Setup 177
 - Using Designer 180
- ◆ **Default front panel display screens** 183
 - NORM mode display screens 183
 - ALT mode default display screens 183
 - TEST mode default display screens 186

Introduction

The meter ships with pre-configured front panel display screens designed to suit the data needs of most users. Different types of screens are available depending on the meter's current mode of operation (see "Modes of operation" on page 26 for details).

Front panel displays can also be customized on your meter to show virtually any measurement or calculation. For example, you can:

- ◆ change displayed parameters, such as from *Vll* to *Vln* or *Vllab* to *Vlna*
- ◆ adjust character size to be different on each screen
- ◆ change data display settings such as backlight timeout, automatic display scrolling, parameter update rate, display mode and display units.

Configuring front panel displays

Using the front panel

You cannot configure displays from the front panel.

Using ION Setup

The following sections explain how to add or edit a display screen, and how to set up scaling for a display.

Adding or editing a display screen

In ION Setup:

1. Open the Setup Assistant for your meter. See the ION Setup Help for instructions.
2. Select the **Displays** screen.
3. Select Displays on the **Front Panel** tab and click **Edit**.

ION Setup uploads your meter's display information to the Display Editor. This can take a few moments.

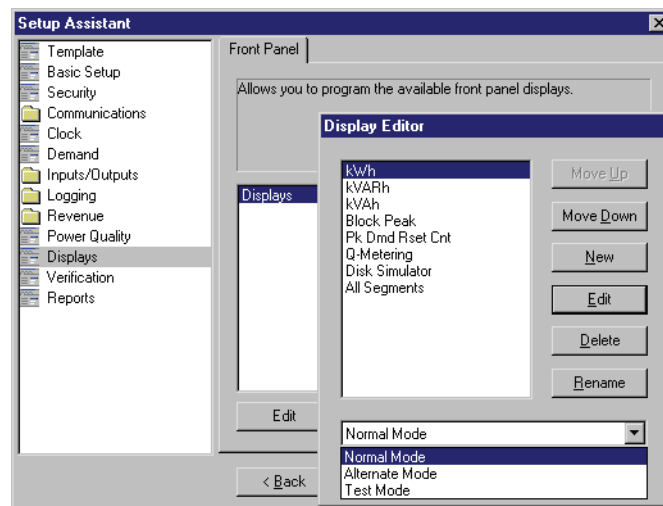

4. Edit, rename, delete or rearrange displays as needed.
5. Click New to add a new display or click Edit to change an existing display. The Display Setup wizard appears. There are three basic steps for creating or editing display screens.

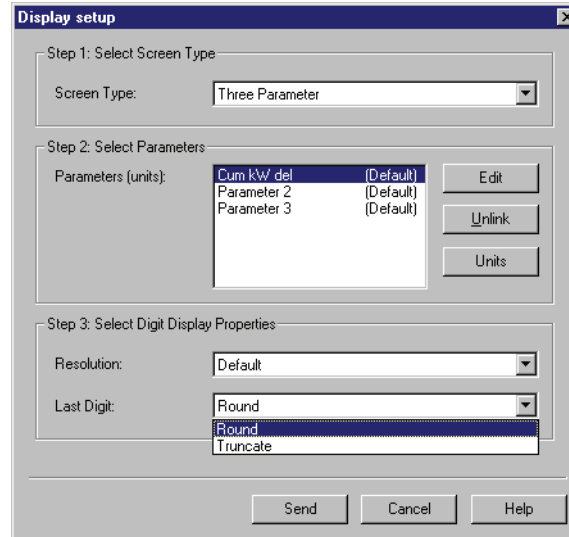

- ◆ **Select a Screen Type:** Choose the screen type you want from the dropdown list.
 - ◆ **Select Parameters:** Link or unlink the parameters available for your chosen screen type. Assign your preferred display units (if required); see “Considerations when assigning display units” on page 178 for considerations and examples of display unit scaling.
 - ◆ **Select Digit Display Properties:** Select your display qualities, including digit resolution and truncated or rounded last digits.
6. Click **Send** to save the changes in the meter.

Considerations when assigning display units



NOTE

If you want to scale all front panel values by the same scaling factor, you do not need to assign display units to individual parameters. Instead configure the display scaling settings under the DISPLAY SETUP menu on the front panel; see “DISPLAY SETUP menu” on page 36. You can also configure the display scaling settings by accessing the Display Options module; see the *ION Reference* for more information.

For most values, the meter determines and displays the correct units for the source measurement, and automatically scales displayed values for readability. If these units meet your needs, you do not need to configure display unit scaling. Assigning display units allows you to: 1) override the default units and force a certain scaling or 2) to display units when the meter cannot determine the correct units (for example, when the source is an output from an Arithmetic module).

For the purposes of the display units, the source parameter is assumed to be in the base units of the Power Meter module (in other words, V, A, kW, etc.). If the source parameter is not in the base units of the Power Meter module, the parameter may be scaled incorrectly or display incorrect units.

**NOTE**

You can only assign display units to One, Two, Three and Four Parameter screens and One, Two and Three Parameter with Timestamp screens.

The available units are:

◆ Default	◆ V, kV, MV	◆ A, kA, MA	◆ kw, MW, GW
◆ kVAR, MVAR, GVAR	◆ kVA, MVA, GVA	◆ Vh, kWh, MVh	◆ Ah, kAh, MAh
◆ kWh, MWh, GWh	◆ kVARh, MVARh, GVARh	◆ kVAh, MVAh, GVAh	◆ LD/LG ¹
◆ IND/CAP ¹	◆ Hz	◆ %	◆ Blank

¹ Power factor related units will not scale or change based on the input value. They are always assumed to be coming from a lagging source or a leading source.

The following example illustrates display unit scaling on a three parameter screen, including the case when the parameter is not in the base units from the Power Meter module. In the example, the kW tot value from the Power Meter module is 10000.

- ◆ Parameter 1 = kW tot directly from the Power Meter module
- ◆ Parameter 2 = kW tot from an Arithmetic module that has divided the Power Meter module value by 1000, converting it to MW.
- ◆ Parameter 3 = kW tot from an Arithmetic module that does not scale the value from the Power Meter module.

Configuration	Displayed value	Notes
Default	Parameter 1 = 10000 kW Parameter 2 = 10 Parameter 3 = 10000	Parameter 2 and 3 do not display units because they come from Arithmetic modules
kW	Parameter 1 = 10000 kW Parameter 2 = 10 kW Parameter 3 = 10000 kW	Parameter 2 and 3 do not change since they are assumed to be in the base units of the Power Meter module. However, parameter 2 is shown as 10 kW when it has already been scaled to 10 MW.
MW	Parameter 1 = 10 MW Parameter 2 = 0.01 MW Parameter 3 = 10 MW	All three parameters are scaled. However, parameter 2 has been scaled twice.

Using Designer



NOTE

Before you reconfigure or delete a framework, it is recommended that you make a copy. This ensures that you can restore the framework, if necessary, without having to reinitialize the factory configuration.

To remove a data display screen

1. Open your meter in Designer.
2. Select the Display module responsible for the screen.
3. Press DELETE. This also deletes all links to that particular Display module.

If the display screen you are deleting is part of the automatic scrolling cycle, you must reconfigure the links from the Scroll module's *Trigger* outputs to the remaining Display modules so that the following considerations hold true:

- ◆ The first Display module in the scrolling cycle is linked to the *Trigger 1* output of the Scroll module.
- ◆ The last Display module in the scrolling cycle (module *n*) is linked to the *Trigger n* output of the Scroll module. For example, if your scrolling cycle consists of 5 screens, *Trigger 5* should be linked to the fifth module in the cycle.
- ◆ The *Wraparound* setup register of the Scroll module designates the last trigger output (*Trigger n*). Expanding on the previous example, since *Trigger 5* is the last trigger, the Scroll module's *Wraparound* setup register would have a value of 5.

To add a new display screen

1. Create a Display module.
2. Define the modules characteristics (display format) by adjusting its setup registers.
3. Link any required data to the *Source* inputs of the Display module.

If you want your new screen to appear in the automatic scrolling cycle, you must link the *Show* input of the Display module to a *Trigger* output of a Scroll module.

To create a Disk Simulator screen

1. Create a new Display module and set the type as *Disk Simulator*.
2. Connect the new Display module's first input to the Calibration Pulsar module's *Disk Position* output that you want to monitor for its pulsing interval.
3. To include the newly added screen to the ALT screen list, connect the Display module's *Show1* and *Show2* inputs to the Scroll module's last available *Trigger* outputs in ALT SCROLL UP and ALT SCROLL DOWN (respectively).

You can determine the last available *Trigger* by right-clicking on the output to discover the *Triggers'* owners.

4. Increase the Scroll module's *Wraparound* setup register by 1 to include the new screen.
5. Configure the remaining display settings according to your needs.

Although the Disk Simulator display is intended to show the disk behavior of mechanical watt-hour meters, this feature can be used to monitor any accumulated meter quantity over the time. To do this, connect the Display module's first input to the meter quantity and connect the second input to the maximum value that you expect the displayed quantity to be bounded by (this can be any output register or an *External Numeric* module register). In a case where the Display module is *not* connected to a Calibration Pulser module, the Disk Simulator revolves from left to right.

If the associated Calibration Pulser module is set for NET accumulation, and a negative value is accumulated and sent to the Disk Simulator display, the negative number on the display will be a negative accumulation, but the display disk will still go from left to right (forwards). To make the display disk go from right to left (backwards), set the associated Calibration Pulser module's *Int Mode* register to reverse.



NOTE

The inputs to the Disk Simulator display are always positive. If the value exceeds the maximum scale value assigned in the second input, nothing is displayed except labels and the disk rectangle.

To configure leading zeros

The leading zeros and decimal point in a numeric display can be configured with the Display module setup register *Screen Resolution*. For example, the number 276.3443 can be configured in one of the following ways, depending on the selection you make in the *Screen Resolution* setup register:

Value	Screen resolution		
276.3443	1.x	=	276.3
	1234.xx	=	0276.34
	123456.	=	000276.

If the *Screen Resolution* setup register is set to DEFAULT, the Display module uses the resolutions defined in the Display Options module.

Last digit mode

The Display module setup register *Last Digit Mode* lets you specify whether to truncate or round a value's last digit. Numbers round up at 5 or greater and round down from 1 to 4. A truncated value disposes of any digits after the number of decimal places that you specified in the *Screen Resolution* setup register.

Screen resolution = 1.xxx			
Value	=		276.35192
Rounded	=		276.352
Truncated	=		276.351

To configure parameter titles

The parameter value on a display screen is the value of an output connected to the Display module *Source* input register. By default, the displayed parameter's title is the name of the output connected to the *Source* input. The Display module *Source Title* setup register lets you change the default to a title that better describes your system. For example, if "KWh Net" is linked to the first *Source* input, you can change its display name by setting *Source 1 Title* to "KWh Net West". A maximum of 25 characters is permitted.

See "Changing TEST mode timeout" on page 192 for information on configuring TEST mode display timeouts.

Default front panel display screens

Each mode of operation (NORM, ALT and TEST) has its own display screens, providing various power system data and meter properties screens.

NORM mode display screens

The meter comes factory-configured with the NORM mode displays detailed below. If the settings in the Scroll module have not been altered, each screen is displayed for five seconds (if no front panel buttons are pressed).

Display scrolling is suspended when a front panel button is pressed, allowing you to manually scroll through the display screens using the up or down arrow buttons. If required, refer to “Front panel features” on page 20 for more instructions on using the front panel buttons.

- ◆ kWh: This screen displays kWh delivered and received values.
- ◆ kVARh: This screen displays kVARh delivered and received values.
- ◆ kVAh: This screen displays kVAh delivered and received values.
- ◆ Peak Demand Delivered: This screen displays the maximum delivered kW, kVAR, kVA values and a timestamp of when the peak occurred. These values are sliding window (rolling block) demand calculations.
- ◆ Peak Demand Reset Count: This screen displays a count of the number of demand resets executed as well as a timestamp of the latest peak demand reset.
- ◆ Q Metering: This screen displays approximated VARh measurements, one phase (60 degrees) behind the normal watt-hour connection (90° - 330° and 150° - 270°).
- ◆ Disk Simulator: This display simulates the behavior of a mechanical watt-hour meter indicating power received or delivered by the direction of the pulse.
- ◆ All Segments: This is a screen test where a black screen showing all segments (all pixels on) indicates that the display is functioning properly.

ALT mode default display screens

The meter comes factory-configured with the ALT mode displays detailed below. If the settings in the Scroll module have not been altered, each screen is displayed for five seconds if no front panel buttons are pressed (until five minutes have elapsed).

Viewing ALT display modes

1. Press the **Alt/Enter** button once to toggle between the NORM and ALT display modes.
2. Press the up or down arrow buttons to scroll back or forth through the displays.

If no buttons are pressed, the meter reverts back to NORM mode after five minutes.

**NOTE**

These screens vary depending on the firmware version on the meter and custom display configuration.

- ◆ **Name Plate 1:** The Name Plate 1 screen contains information on owner, TAG1, TAG2, battery life, and firmware version and feature set of the meter.

TAG1 and TAG2 typically identify the meter's user and installed location. The Owner and TAG registers are located in the Factory module and are configurable with ION Enterprise or ION Setup. See "How to TAG your meter" on page 40.

- ◆ **Name Plate 2:** This screen displays the following information for the current sliding window (rolling block) demand settings:

	Sliding Window (Rolling Block)
CONFIG	Length of the demand period multiplied by the number of demand periods
UPDATE	Length of the demand period
SYNC	Clock synchronization source
MAX (kW)	Maximum kW Demand ¹

¹ The MAX (kW) value is a maximum allowable demand level based on installed transformer configurations and nominal voltages and currents.

- ◆ **Event Log:** The Event Log screen displays up to four of the most recent, high priority events (priority 255 only). The date, a timestamp, an event description, and an event code are provided for each event displayed. If more than four high priority events have been recorded, the Event Log screen indicates additional logs exist. Refer to "Data logging" on page 148 for more details.
- ◆ **Phasor Diagram:** This screen shows phasors and numeric values for each phase current and phase voltage measurement.
- ◆ **Instantaneous Voltage:** This screen shows the phase voltage and average voltage (line-to-neutral or line-to-line voltage, depending on the meter's service type).
- ◆ **Instantaneous Current:** This screen shows the phase current and average current values.
- ◆ **Instantaneous Power:** This screen shows kW total, kVAR total, kVA total and signed Power Factor total values.
- ◆ **Instantaneous Demand:** This screen shows kW delivered and received from the sliding window (rolling block) demand calculation.
- ◆ **Voltage Harmonics:** These screens show per-phase voltage harmonic histograms.
- ◆ **Current Harmonics:** These screens show per-phase current harmonic histograms.
- ◆ **Instantaneous Demand:** This screen shows kW delivered and received.

- ◆ Flicker (ION8650A and ION8650B only): This screen displays flicker measurements from V1, V2 and V3.
- ◆ Frequency: This screen displays frequency information.

ALT mode Time of Use (TOU) display screens

The ALT mode TOU display screens are factory-configured to show Time of Use (TOU) data. The measurements displayed originate from frameworks of modules that are linked to a TOU module. By default, only one season is configured in the sample TOU schedule; until you configure other seasons, all data appears under that one season. For details about the TOU module, refer to the *ION Reference*.

By default, all demand values result from sliding window (rolling block) calculations.



NOTE

The following abbreviations are used on the TOU display screens:

PB = Past Billing period. A billing period is the time between two consecutive meter readings for billing purposes by a utility.

PS = Previous Season. Billing Seasons are defined in the TOU module description in the *ION Reference*.

- ◆ Active TOU Rate: This screen shows which of the valid TOU billing rates is active.
- ◆ Active TOU Season: This screen shows which TOU billing season is currently active.
- ◆ TOU Energy by Rate: This screen shows kWh delivered values for each TOU rate.
- ◆ kW Peak Demand: These screens display the maximum kW delivered value for each TOU rate. These values result from sliding window (rolling block) demand calculations.
- ◆ Past Billing Energy: This screen displays the kWh delivered values for each TOU rate in the previous billing period.
- ◆ Past Billing Peak Demand: These screens display the maximum kW delivered value for each TOU rate in the previous billing period. These values result from sliding window (rolling block) demand calculations.
- ◆ Past Season Energy: This screen displays the kWh delivered for each TOU rate in the past billing season. These values result from sliding window (rolling block) demand calculations.
- ◆ Past Season Peak Demand: These screens display the maximum kW delivered for each TOU rate in the past billing season.
- ◆ Past Billing/Season Energy: These screens display the kWh delivered and received values in the past billing period and billing season.
- ◆ Past Bill/ Season Pk Demand: These screens show the maximum kW received values in the past billing period and billing season. These values result from a sliding window (rolling block) demand calculation.
- ◆ Past Billing/Season Energy: These screens display the kVARh delivered and received values in the past billing period and billing season.

- ◆ Past Bill/Season Pk Demand: These screens display the maximum kVAR delivered and received values in the past billing period and billing season. These values result from a sliding window (rolling block) demand calculation.
- ◆ Past Billing/Season Energy: These screens display the kVAh delivered and received values in the past billing period and billing season.
- ◆ Past Bill/Season Pk Demand: These screens display the maximum kVA delivered and received values in the past billing period and billing season. These values result from a sliding window (rolling block) demand calculation.

TEST mode default display screens

The values shown in the TEST mode display screens represent different accumulators than those shown in NORM mode (although they perform some of the same basic measurements). The TEST mode display values are for the purpose of checking accuracy; they only accumulate while the meter is in TEST mode.

Viewing TEST mode

There are two ways to switch the meter into TEST mode depending on the type of meter you have:

- ◆ Standard meter (without hardware lock): You must use ION Enterprise or ION Setup; refer to “Switching to TEST mode” on page 189.
- ◆ Standard hardware-locked meter: You must remove the cover from the meter and press the TEST mode button; refer to “Performing a master reset from the front panel” on page 199 for detailed instructions on removing the meter’s cover.

When the meter is in TEST mode, the front panel cycles through four TEST mode display screens:

- ◆ kWh Test: This screen shows TEST mode kWh delivered and received values.
- ◆ kVARh/KVAh Test: This screen shows TEST mode kVARh/KVAh delivered and received values.
- ◆ Instantaneous Demand Test: This screen shows TEST mode kW delivered and received values. Both quantities are produced from a sliding window (rolling block) demand calculation. This value is reset if the demand reset switch is turned while the device is in TEST mode.

Chapter 17 TEST mode

This chapter describes your meter's TEST mode and explains how to switch from Normal mode to TEST mode.

In this chapter

- ◆ **Introduction** 188
- ◆ **Switching to TEST mode** 189
 - Using the front panel 189
 - Using ION Setup 189
 - Using Vista 191
- ◆ **Changing TEST mode timeout** 192
 - Using the front panel 192
 - Using ION Setup 192
 - Using Designer 193
- ◆ **TEST mode default display screens** 194
- ◆ **TEST mode LED energy pulsing** 195

Introduction

TEST mode is typically used for verifying meter function. The meter is usually reading data from a test power supply while these functions are performed.

Several things to note about TEST mode:

- ◆ All of the billing quantities that are recorded when the meter is in Normal mode stop accumulating when the meter is switched to TEST mode — the data is sent to special TEST mode registers instead.
- ◆ The values accumulated in these test registers are displayed on the front panel and in ION Enterprise or ION Setup.
- ◆ The regular normal mode billing registers are unaffected while the meter is in TEST mode; accumulation of this data continues as soon as you exit TEST mode.
- ◆ All test registers are reset to zero when you exit TEST mode.



NOTE

The meter always returns to NORM mode when you exit TEST mode, even if you entered TEST mode from ALT mode.

You cannot place a hardware-locked meter in TEST mode using ION Enterprise or ION Setup. The meter must be placed in TEST mode using the front panel.

Refer to the *PowerLogic ION8650 accuracy verification* technical note for final accuracy verification test details and procedure.

Switching to TEST mode

Place the meter into TEST mode using the front panel, ION Setup or Vista. The meter's front panel informs you when the meter is in TEST mode with a special display screen.

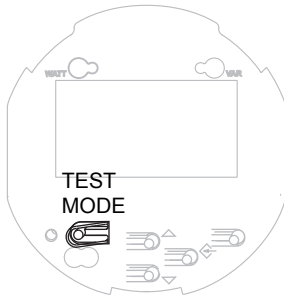

Using the front panel

The TEST mode button on the meter is located beneath the outer cover. You must first remove the cover to access the button. Refer to the *ION8650 Installation guide* for instructions and safety precautions.

DANGER

HAZARD OF ELECTRIC SHOCK

Wear PPE and take precautions not to touch the meter's lever contact switches if accessing the front panel buttons of a switchboard meter.

Failure to follow these instructions will result in death or serious injury.

After you remove the outer cover, press the TEST mode button.



NOTE

If you have a hardware-locked meter, only the basic communications parameters can be changed in NORM mode. You must enter TEST mode to change other meter parameters on the hardware-locked meter. See "Additional revenue metering security" on page 68 for more details.

Using ION Setup



NOTE

You cannot place a hardware-locked meter in TEST mode using ION Setup. The meter must be placed in TEST mode using the front panel. See "Using the front panel" on page 189.

In ION Setup:

1. Open the Setup Assistant for your meter. See the ION Setup Help for instructions.
2. Select the **Verification** screen.

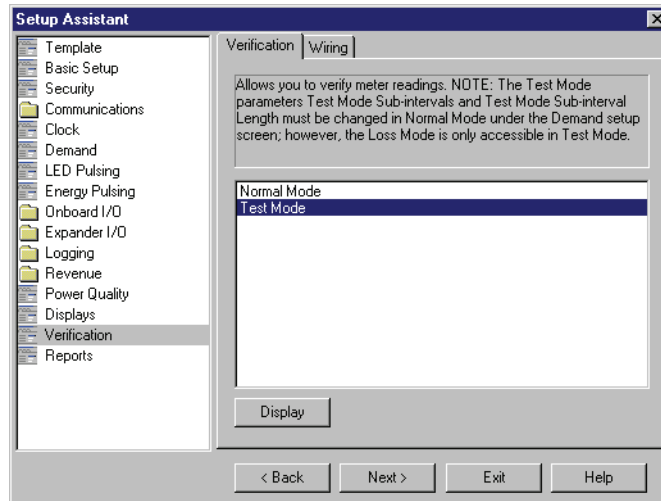

3. Select **Test Mode** on the Verification tab and click **Edit**. Enter your meter password if prompted. A dialog box informs you that the meter is in Test mode. Click **OK**.

The Test Mode screen appears and test values are displayed.

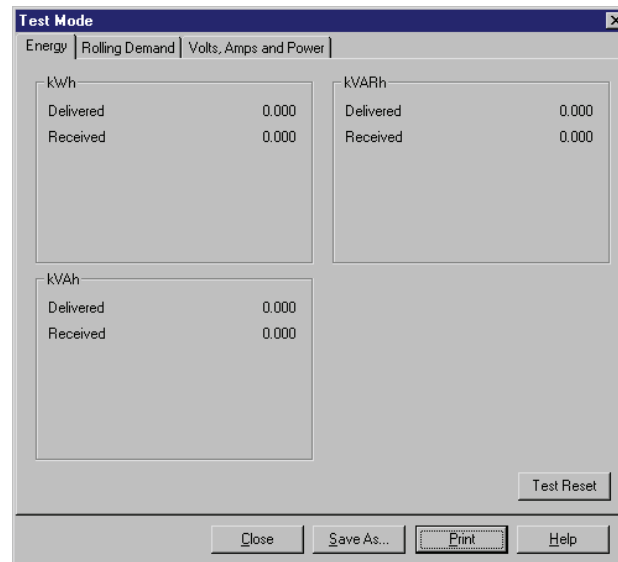

Click on the tabs to perform various test-related tasks. See the ION Setup online help for more information.

4. Click **Scaling** on the **Energy** tab if you want to apply PT/CT scaling to the values displayed in Test mode. The default is OFF (no scaling is applied).
5. Click **Loss Mode** on the **Volts, Amps and Power** tab if you want any transformer loss compensation that you have configured to values in TEST mode.
6. Click **Close**. A dialog box informs you that the meter is back in Normal mode.

Using Vista



NOTE

You cannot place a hardware-locked meter in TEST mode using ION Enterprise. The meter must be placed in TEST mode using the front panel. See "Using the front panel" on page 189.

1. Open your meter in Vista.
2. Select the **Setup/Diagnostics** tab and click **General Setup**.
3. Select the Test Mode option for Meter Mode. You are prompted for the ION Enterprise user password. If meter security is enabled, you are also prompted for the meter password. For more information see the Vista section of the online *ION Enterprise Help*.

Changing TEST mode timeout

If no front panel buttons are pressed, the meter exits TEST mode after 30 minutes (1800 seconds) by default, if the default TEST mode timeout value has not been changed. The timeout value resets to 30 minutes each time you press any front panel button. While in TEST mode, the value on the bottom right of the status bar indicates the amount of time before TEST mode times out. The meter always returns to NORM mode when the TEST mode timeout elapses.

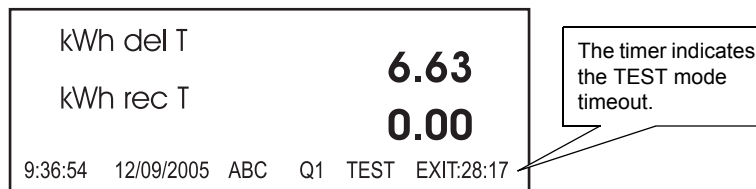

You can change the value of the TEST mode timeout using ION Enterprise, ION Setup or the front panel.

Using the front panel

Follow these steps to change the TEST mode timeout using the front panel:



NOTE

You must be in TEST mode to change the TEST mode timeout if your meter is hardware-locked.

1. Enter the SETUP menu by holding down the **ALT/ENTER** button.
2. Scroll through the menu items, highlight DISPLAY OPTIONS, and press the **ALT/ENTER** button.
3. Scroll down and highlight the TEST MODE TO menu item. Press **ALT/ENTER**. The current TEST mode timeout is displayed.
4. Enter the new value of the TEST mode timeout in seconds. Use the up or down arrow buttons to change the value of the highlighted digit. Press the up or down arrow button to change the position of the highlight cursor. Press the **ALT/ENTER** button.
5. Select YES to confirm the change. Enter the meter password if prompted.

Using ION Setup

In ION Setup:

1. Connect to the meter in Advanced Mode. See the ION Setup Help for instructions.
2. Locate the Display Options module in the module list and double-click to open the module.
3. Click the Setup Registers tab and double-click the *Test Mode Timeout* setup register.

4. Set the *Test Mode Timeout* to the desired time. You can choose from a numeric bounded format or an elapsed interval format.
5. Click **Send** to save the changes to the meter.

Using Designer

1. Open your meter in Designer.
2. Double-click the Display Setup folder.
3. Right-click on the Display Options module to access the setup registers. Select the *Test Mode Timeout* setup register and click **Modify** to edit.
4. Set the *Test Mode Timeout* to the desired time.
5. Click **OK** to send the changes to the meter.

TEST mode default display screens

The values shown in the TEST mode display screens represent different accumulators than those shown in NORM mode (although they perform some of the same basic measurements). The TEST mode display values are for accuracy checking purposes; they only accumulate while the meter is in TEST mode.

In TEST mode, the front panel cycles through four TEST mode display screens:

- ◆ kWh TEST: This screen shows TEST mode kWh delivered and received values.
- ◆ kVARh/KVAh TEST: This screen shows TEST mode kVARh/KVAh delivered and received values.
- ◆ Instantaneous Demand TEST: This screen shows TEST mode kW delivered and received values. Both quantities are produced from a sliding window (rolling block) demand calculation. This value is reset if the demand reset switch is turned while the device is in TEST mode.

TEST mode LED energy pulsing

Above the display screen are two pairs of energy pulsing LEDs and infrared outputs. The LEDs and IR outputs are factory-configured to pulse while the meter is in TEST mode.

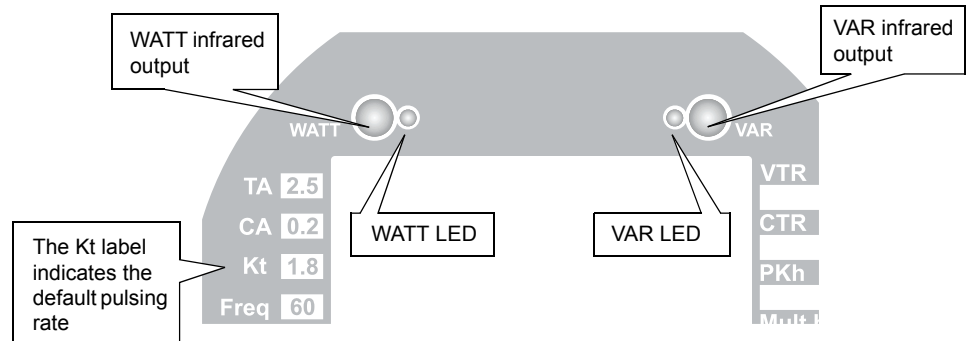

The energy pulsing LEDs provide an interface for accuracy checking instruments. The Kt label indicates the factory-configured pulsing rate. (You can change the energy pulsing frequency with ION Enterprise or ION Setup.) See "Configuring energy pulsing" on page 144 for more information on configuring the LED settings.

Chapter 18 Resets

This chapter provides instructions for performing various meter resets.

In this chapter

- ◆ **Performing a reset** **198**
 - Performing a master reset 198
 - Parameters affected by a master reset 198
 - Performing a demand reset 199
 - Parameters affected by a demand reset 199
 - Demand Lockout Time 199
 - Using the front panel 199
 - Performing a master reset from the front panel 199
 - Performing a demand reset from the front panel 200
 - Using ION Setup 200
 - Using Vista 201
 - Master resets and hardware-locked meters 202

Performing a reset

Resets allow you to clear various accumulated parameters stored by the meter.

Performing a master reset

To perform a master reset on a hardware-locked meter, you must remove the front cover and press the master reset button. See “Master resets and hardware-locked meters” on page 202 for more information.

With a meter that is not hardware-locked, you can perform a master reset via software. It does not have to be in TEST mode.



NOTE

Be sure to record any important data before performing a meter reset.

Parameters affected by a master reset

The master reset deletes most accumulated values and all derived revenue measurements from the meter, clears the meters event and waveform logs, and clears COMTRADE waveform records from the meter's internal FTP server. The mode that the meter is in (NORM mode or TEST mode - see “Modes of Operation” on page 31) defines the values that are reset.

NORM or ALT mode

In NORM or ALT mode, the following parameters are reset to zero:

- ◆ Energy and Demand
- ◆ Peak Demand
- ◆ Loss Calculation
- ◆ Long-term Min/Max
- ◆ Power Quality disturbance counters
- ◆ Time of Use

The following are cleared:

- ◆ Event Log
- ◆ All Data Recorders
- ◆ All Waveform Recorders
- ◆ All COMTRADE files

TEST mode

All TEST mode Energy and Demand measurements are set to zero.

Performing a demand reset

Parameters affected by a demand reset

The mode that the meter is in (for example, NORM mode or TEST mode) defines the values that will be reset.

- ◆ NORM mode: resets the peak demand values logged in the meter.
- ◆ TEST mode: resets the test demand parameters to zero.

Demand Lockout Time

The setup register labeled *Demand Lockout Time* (Display Options module) sets the minimum time allowed between consecutive demand resets; the meter ignores any attempts to reset the demand outside the bounds of the register.

The default value for the Demand Lockout time is 25 days. For details on the Demand Lockout Time setup register, refer to “Configuring demand reset lockout time” on page 126.

For more details on the Display Options module, see the *ION Reference*.

Using the front panel

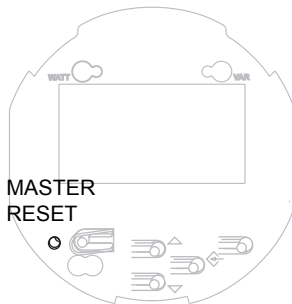

Performing a master reset from the front panel

The master reset button is recessed to avoid accidental activation. You must first remove the meter's cover before you can perform a master reset.

⚠ DANGER

HAZARD OF ELECTRIC SHOCK

Wear PPE and take precautions not to touch the meter's lever contact switches if accessing the front panel buttons of a switchboard meter.

Failure to follow these instructions will result in death or serious injury.

1. Remove the front cover of the meter. Refer to the *ION8650 Installation guide* for instructions and safety precautions.
2. Using a pin or similar instrument, press and hold the master reset button until a message displays stating that the master reset is in progress.



NOTE

Do not configure or power down your meter until the meter's front panel displays a message stating that the master reset is complete. If you configure or power down your meter during a master reset, the affected parameters may not be completely reset.

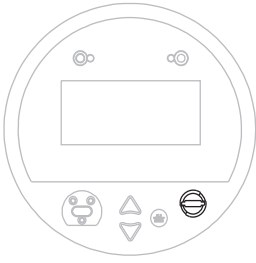

Performing a demand reset from the front panel

The demand reset switch can be activated with the cover on or off.

In most applications, the demand reset switch is sealed with an anti-tamper mechanism; a through-hole in the switch can accommodate either an external seal or a locking mechanism. See “Demand reset switch seal” on page 69 for details of anti-tamper sealing.

Using ION Setup

In ION Setup:

1. Open the Setup Assistant for your meter. See the ION Setup Help for instructions.
2. Select the **Verification** screen.
3. Select Normal Mode and click **Display**.

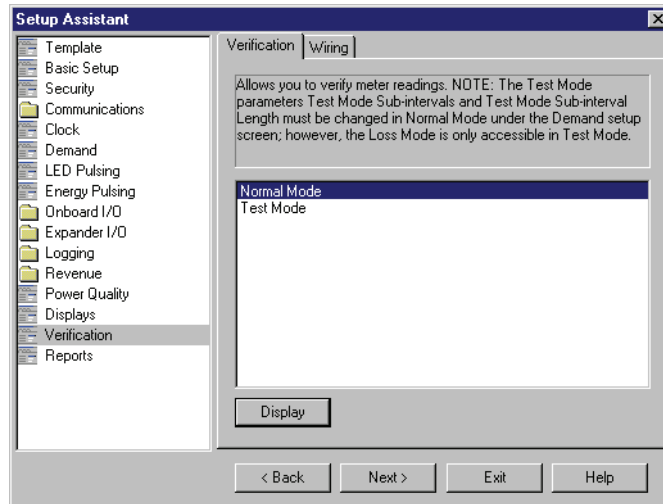

4. Select the desired tab in the Normal Mode dialog box. Two resets are available: Peak Reset and Master Reset. Click the appropriate button to perform the reset (Peak Demand in the example below).



NOTE

The master reset is not accessible via software in a hardware-locked meter, whether the meter is in TEST, ALT or NORM mode. A master reset on a hardware-locked meter can only be performed from the front panel. See “Master resets and hardware-locked meters” on page 202 for details.

With a meter that is not hardware-locked, you can perform a master reset via software. It does not need to be in TEST mode.

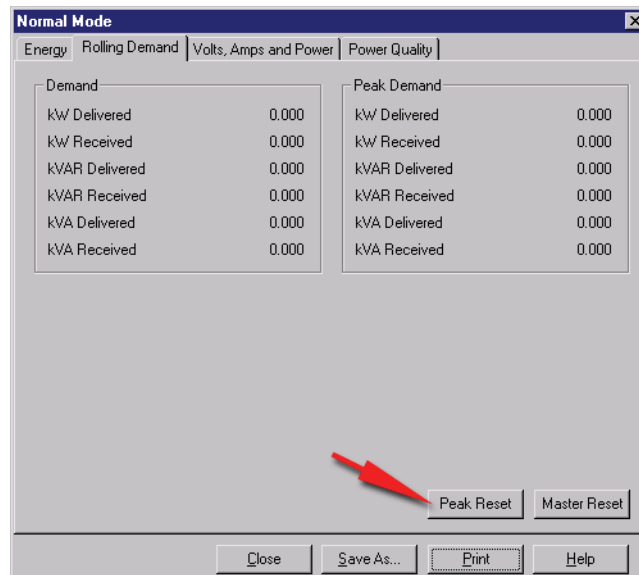

A dialog box informs you when the reset is complete.



NOTE

Do not configure or power down your meter until a message appears stating that the master reset is complete. If you configure or power down your meter during a master reset, the affected parameters may not be completely reset.

Using Vista

Open your meter in Vista. You can perform several resets from within Vista.

Performing a master reset



NOTE

The master reset is not accessible via software in a hardware-locked meter, whether the meter is in TEST, ALT or NORM mode. A master reset on a hardware-locked meter can only be performed from the front panel. See "Master resets and hardware-locked meters" on page 202 for details.

With a meter that is not hardware-locked, you can perform a master reset via software. It does not need to be in TEST mode.

1. Click the **Setup/Diagnostics** tab and click the **General** icon.
2. Click the **Master Reset** icon.



NOTE

Do not configure or power down your meter until a message appears stating that the master reset is complete. If you configure or power down your meter during a master reset, the affected parameters may not be completely reset.

Performing a peak demand reset

1. Click the **Revenue** tab and click the **Demand Max** icon.
2. Click the **Peak demand reset** icon.

Performing a Min/Max reset

1. Click the **Volts/Amps** tab and click the **Long-term min/max** icon.
2. Click the **Reset Min/Max** icon.

Performing a Sag/Swell or Harmonics Min/Max reset

1. Click the **Power Quality** tab
2. Click **Reset counters** to reset the disturbance counters. Click the **Harmonics Details** icon then click **Reset Min/Max** to reset the harmonics min/max values.

Master resets and hardware-locked meters

The master reset is not accessible via software in a hardware-locked meter, whether the meter is in TEST, ALT or NORM mode. A master reset on a hardware-locked meter can only be performed from the front panel.

TEST mode

In TEST mode, a screen is displayed stating that the master reset is unavailable:

**Normal mode, Locked**

In this case the meter attempts the master reset, but revenue and event logs are not cleared. The rest of the master reset is successful.

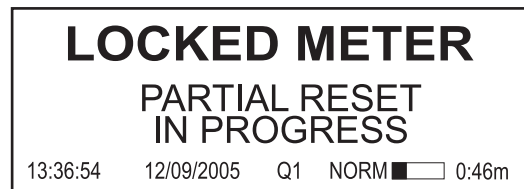

Chapter 19 Setpoints

This chapter provides instructions for configuring meter setpoints.

In this chapter

- ◆ **Introduction** **204**
- ◆ **Configuring setpoints** **205**
 - Using the front panel 205
 - Using ION Setup 205
 - Using Vista 205
 - Relative Setpoint module settings 205
 - Fine tuning over condition monitoring 206

Introduction

The Relative Setpoint module provides extensive non-critical control, secondary protection, and analysis capabilities by allowing you to initiate an action in response to a specific condition. It is particularly useful for performing actions based on differences between a value (for example, kW on phase A) relative to a reference value (for example, kW demand for all three phases). Use this module's outputs for demand control of equipment or any other applications requiring setpoint activity relative to a varying value. See the *ION Reference* for more information on the Relative Setpoint module.

WARNING

HAZARD OF UNINTENDED OPERATION

- Do not use the meter for critical control or protection applications where human or equipment safety relies on the operation of the control circuit.
- Be aware that an unexpected change of state of the digital outputs may result when the supply power to the meter is interrupted or after a meter firmware or template upgrade.

Failure to follow these instructions can result in death, serious injury or equipment damage.

Configuring setpoints

Use ION Enterprise or ION Setup to change your meter's setpoints.

Using the front panel

You cannot configure setpoints using the front panel.

Using ION Setup

In ION Setup:

1. Connect to your meter in Advanced Mode.
2. Click on the Relative Setpoint module you want to configure.

Using Vista

Open your meter in Vista and click on the **Setpoints** tab. Click the **Setup** icon. Use the switches to turn various monitoring on and off (see circled below). Click the numeric boxes to edit condition settings.

Relative Setpoint module settings

By default, the following Relative Setpoint modules are configured:

Label	Description
Over KW sd	When active, this annunciates when the total kW sliding window demand exceeds a specified amount.
Over I a	When active, this annunciates when the current on phase A exceeds a specified amount.
Over I b	When active, this annunciates when the current on phase B exceeds a specified amount.
Over I c	When active, this annunciates when the current on phase C exceeds a specified amount.
Over V unbal	When active, this annunciates if the voltage unbalance exceeds a specified amount.
Phase 1 loss, Phase 2 loss, Phase 3 loss	When active, these annunciate if the phase voltage drops below the Sag/Swell module's <i>Nom Volts</i> register by a specified amount.
V1, V2, V3 (+/- 15%) for 10m, 10s, 3s	When active, these annunciate when the phase voltage deviates from the Sag/Swell module's <i>Nom Volts</i> register by a specified amount.



NOTE

There is usually no need to change any of the Relative Setpoint modules' setup registers for normal operation of the meter.

See the *ION Reference* for more information on the Relative Setpoint module.

Fine tuning over condition monitoring

If you want to fine-tune over condition monitoring, the only setup registers you should change are *SusUntlON* and *SusUntlOFF*.

SusUntlON determines how long the modules wait after an over condition is detected before reporting it. This gives the monitored value a short period to correct itself before the event is registered with the module so that very brief over conditions are ignored. Similarly, *SusUntlOFF* is the amount of time a normal value must be present before the module considers normal operation to be restored. Both *SusUntlON* and *SusUntlOFF* values are entered in seconds.

Chapter 20 Reports

This chapter provides instructions for viewing various meter reports and logs.

In this chapter

- ◆ **Introduction** **208**
- ◆ **Viewing meter logs** **209**
 - Using the front panel 209
 - Using ION Setup 209
 - Using Vista 210

Introduction

Accumulated meter values are saved in logs. These logs can be acquired by your energy management software (such as ION Enterprise) and saved in its database for analysis and reporting.

The Web Reporter component of ION Enterprise is a database reporting application that lets you define, generate, and manage comprehensive reports based on the information in your system database. It processes selected data and generates a finished report.

For more information on reports, see the Web Reporter section of the online *ION Enterprise Help*.

Viewing meter logs

View meter logs using ION Enterprise, ION Setup or the front panel.

Using the front panel

The front panel only displays recent high priority events (Event Log).

DATE	TIME	EVENT	CODE
12/08/2010	10:23:45	Shutdown	SD25
12/08/2010	10:42:03	Power Up	SD25
12/08/2010	11:19:26	Changed Setup	SD25
ADDITIONAL LOGS - READ THROUGH COMMS			
9:36:54	12/09/2010	ABC Q1 ALT	█ 11m

Press **ALT/ENTER** to access the ALT display then press the up and down arrow buttons to navigate to the Event Log.

Using ION Setup

In ION Setup:

1. Open the Setup Assistant for your meter. See the ION Setup Help for instructions.
2. Select the **Reports** screen.

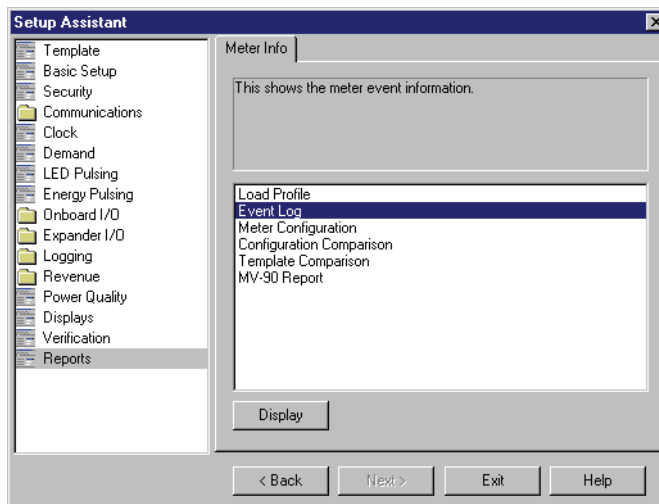

3. Select one of the logs or comparisons in the list and click **Display** to view the associated log.

Below is an example of an Events Log.

Date/Time	Cause	Value	Effect	Value
15/11/2004 1:23:12.583 PM	Front Panel	Changed Setup	SD39 Sub Intvl	900
15/11/2004 1:23:12.884 PM	Front Panel	Changed Setup	SD40 Sub Intvl	900
15/11/2004 1:23:13.045 PM	Front Panel	Changed Setup	SD41 Sub Intvl	900
15/11/2004 1:23:13.444 PM	Front Panel	Changed Setup	SD42 Sub Intvl	900
15/11/2004 1:23:13.675 PM	Front Panel	Changed Setup	SD43 Sub Intvl	900
15/11/2004 1:23:13.912 PM	Front Panel	Changed Setup	SD44 Sub Intvl	900
15/11/2004 1:23:14.310 PM	Front Panel	Changed Setup	SD45 Sub Intvl	900
15/11/2004 1:23:14.476 PM	Front Panel	Changed Setup	SD46 Sub Intvl	900
15/11/2004 1:23:14.777 PM	Front Panel	Changed Setup	SD47 Sub Intvl	900
15/11/2004 1:23:14.953 PM	Front Panel	Changed Setup	SD48 Sub Intvl	900
15/11/2004 1:23:15.353 PM	Front Panel	Changed Setup	SD49 Sub Intvl	900
15/11/2004 1:23:15.586 PM	Front Panel	Changed Setup	SD50 Sub Intvl	900
15/11/2004 1:23:15.812 PM	Front Panel	Changed Setup	SD51 Sub Intvl	900
15/11/2004 1:23:15.993 PM	Front Panel	Changed Setup	SD52 Sub Intvl	900
15/11/2004 1:23:16.386 PM	Front Panel	Changed Setup	SD53 Sub Intvl	900
15/11/2004 1:23:16.552 PM	Front Panel	Changed Setup	SD54 Sub Intvl	900
15/11/2004 1:23:16.850 PM	Front Panel	Changed Setup	SD55 Sub Intvl	900
15/11/2004 1:23:16.951 PM	Front Panel	Changed Setup	SD56 Sub Intvl	900

4. You can view, save or print the log. Click **Close** to exit.

See also “Viewing data log information” on page 155 for information on viewing data log information in ION Setup.

Using Vista

Open your meter in Vista and click on the various tabs available. Click an icon to view the associated logs. The following logs are available in Vista:

- ◆ Volts/Amps tab:
 - ◆ Meter Events
 - ◆ Voltage
 - ◆ Current
 - ◆ Power
 - ◆ Frequency/PF
- ◆ Revenue tab:
 - ◆ Logged Interval data
- ◆ Power Quality tab:
 - ◆ Harmonics Trending
 - ◆ Transient & Sag/Swell Statistics CBEMA
 - ◆ Waveforms/Sequence of Events
 - ◆ EN50160

A

- ALT mode
 - display screens 183
 - time of use screens 185
- alt mode
 - switching to 26
- analog outputs 137

B

- basic setup
 - front panel menu 31
- bus wiring 81

C

- Calibration Pulsar module 135, 142
- CBEMA/ITIC 171, 172
- clock
 - configuration 118
 - configuring 120
- Clock module 118
- communications breakout cable 83
- communications options 75
- communications options, ION8650C 76
- communications overview 74
- configuring leading zeros 181
- configuring parameter titles 182
- configuring the meter for ModemGate 94
- connections
 - RS-232 79
 - RS-485 81
- CTR-21 compliant modem 92
- current
 - harmonics display 184

D

- data
 - historical logging 152
- data logging
 - viewing 155
- daylight savings time 121
- default logging framework 150
- demand
 - configuring 125
 - overview 124
- demand forgiveness 127
- demand reset 199
- demand reset lockout time, configuring 126
- demand reset switch 20
- Digital Input module 137
- Digital Output module 135
- digital outputs 135
- display setup
 - menu 36
- displays
 - ALT mode 183

- assigning units 178
- configuring 177
- default displays 183
- disk simulator 24
- histogram 24
- nameplate 23
- numeric 22
- phasor 24
- status bar 22
- time and date 24
- time stamped 25
- types 22

DNP 3.0 protocol 108

E

- EN50160
 - logging 154
- energy pulsing
 - configuring 144
- energy pulsing with LEDs 143
- EtherGate 87
- Ethernet connections 86
- ethernet setup 34
- event
 - event log displays 184
- Event log and nameplate displays 23
- Event Log Controller module 156
- event logging 156
 - displaying 157
- event priority 156
- external events 156

F

- features
 - front panel 20
- format setup menu 36
- front panel
 - accessing the setup menu 28
 - adjusting contrast 22
 - com ports setup 32
 - configuring leading zeros 181
 - configuring parameter titles 182
 - demand reset switch 20
 - display setup 36
 - ethernet setup 34
 - format setup 36
 - LED pulsers 20
 - master reset button 21
 - navigation buttons 21
 - optical port 21
 - security setup 37
 - TEST mode button 21
- front panel changes
 - confirming 30
- front panel features 20

G

getting more information 17

H

harmonics
logs 153
histogram displays 24
histograms
front panel 184
historic data log 152

I

I/O
specifying an I/O port 134
I/O Expander 133
IEC 61000-4-30
logging 155
IEC 61850 protocol 110
instantaneous measurement displays 184
internal modem 91
ION Enterprise
reporting 153
ION8650C communications options 76
IRIG-B time synchronization 119

L

LED pulsers 20
logging
4-30 155
changing log depths 151
changing log frequency 151
configuring 148
default configuration 151
default framework 150
EN50160 154
energy demand 153
events 156
harmonics 153
historical data 152
loss log 152
recording capacity 158
sag/swell 153
transient 153
loss log 152

M

Mains Signalling Evaluation module 170
master reset button
location of 21
parameters affected 198
master resets on hardware-locked meters 202
Modbus, meter as master 103
Modbus, meter as slave 99

modem
internal 91
ModemGate 93
configuring the meter for 94
modes of operation 26
alt mode 26
norm mode 26
test mode 27
molex extension cables 76
MV-90 152
MV90 115
MV-90 protocol 115

N

navigation buttons 21
using 30
norm mode 26
display screens 183
numeric displays 22

O

onboard digital inputs 136
optical port 21
configuring 84
optical probe 76
out of range screen 30
over condition monitoring 206

P

passwords
to upgrade devices 46
Periodic Timer module 151
phasor diagram displays 24
phasor diagrams
front panel 184
Power Meter module 50
power quality setup 170
Pulser module 135, 142

R

Relative Setpoint module 204
revenue log 152
RS-232
connections 79
RS-485
connections 81
RS-485 connections
biasing 82
methods to avoid 82

S

sag/swell
logging 153
Sag/Swell module 171

- Scaled operational values (SOV) 70
- security
 - anti-tamper sealing 68
 - device access for software services 67
 - disabling via front panel 38
 - hardware lock 68
- security setup menu 37
- serial com settings 32
- serial connections 79
- setup
 - power quality 170
- setup menu
 - accessing via front panel 28
 - basic 31
 - com ports 32
 - configuring with navigation buttons 30
 - confirming changes 30
 - network setup 34
 - returning to previous screen 30
 - serial com settings 32
- Sliding window demand module 124
- status bar 22

T

- test mode
 - displays screens 186
 - LED energy pulsing 186
 - switching to 27
 - time out 192
- TEST mode button 21
- time of use
 - configuring 165
 - seasons 166
- Time of Use module 165
- time synchronization 119
 - IRIG-B 119
- TOU
 - front panel screens 185
- transient logging 153
- Transient module 170, 172

U

- upgrading meter 44

V

- voltage
 - harmonics display 184

W

- Waveform Recorder module 150

PowerLogic™ ION8650
User guide

Schneider Electric
2195 Keating Cross Road
Saanichton, BC V8M 2A5 Canada

For technical support:
Global-PMC-Tech-support@schneider-electric.com
(00) + 1 250 544 3010

Contact your local Schneider Electric sales
representative for assistance or go to
www.schneider-electric.com

ION, ION Enterprise, Modbus, Modicon, PowerLogic, Schneider Electric and WebMeter are either trademarks or registered trademarks of Schneider Electric in France, the USA and other countries. Other trademarks used are the property of their respective owners.

Electrical equipment should be installed, operated, serviced, and maintained only by qualified personnel. No responsibility is assumed by Schneider Electric for any consequences arising out of the use of this material.

70002-0306-00 05/2011
© 2011 Schneider Electric All Rights Reserved