

PowerLogic™ PM5300 Series Power and Energy Meter

User Guide

EAV15107 - EN03
04/2014



Safety Information

Important Information

Read these instructions carefully and look at the equipment to become familiar with the device before trying to install, operate, service or maintain it. The following special messages may appear throughout this manual or on the equipment to warn of potential hazards or to call attention to information that clarifies or simplifies a procedure.



The addition of either symbol to a “Danger” or “Warning” safety label indicates that an electrical hazard exists which will result in personal injury if the instructions are not followed.

This is the safety alert symbol. It is used to alert you to potential personal injury hazards. Obey all safety messages that follow this symbol to avoid possible injury or death.

⚠ DANGER

DANGER indicates a hazardous situation which, if not avoided, **will result in** death or serious injury.

⚠ WARNING

WARNING indicates a hazardous situation which, if not avoided, **could result in** death or serious injury.

⚠ CAUTION

CAUTION indicates a hazardous situation which, if not avoided, **could result in** minor or moderate injury.

NOTICE

NOTICE is used to address practices not related to physical injury.

Please note

Electrical equipment should be installed, operated, serviced and maintained only by qualified personnel. No responsibility is assumed by Schneider Electric for any consequences arising out of the use of this material.

A qualified person is one who has skills and knowledge related to the construction, installation, and operation of electrical equipment and has received safety training to recognize and avoid the hazards involved.

Chapter 1:	Introduction	Power and Energy Meter Hardware	9
		Parts and Accessories	9
		Box Contents	9
		Firmware	9
Chapter 2:	Safety Precautions	Before You Begin	11
		Notices	11
Chapter 3:	Hardware Reference	Models, Features and Options	13
		Functions and Characteristics	13
		Technical Specifications	15
		Before you begin	17
		Safety precautions	17
		Dimension	17
		Meter mounting	18
		Mounting the PM5300	18
		Meter wiring	19
		Recommended cables	21
		Wiring Diagrams	22
		Power system	23
		Direct connect voltage limits	23
		Voltage and current input wiring	25
		Balanced system considerations	26
		Control power wiring	26
		Communications	26
		Serial communications	26
		Ethernet communications	28
		Digital outputs	28
		Status inputs	29
		Relay outputs	29
Chapter 4:	Front panel display and meter setup	LED indicators	31
		Heartbeat / communications LED	31
		Alarm / energy pulsing LED modes	31
		Notification icons	32
		Meter screen menus	32
		Menu tree	33
		Meter setup screen navigation	34
		Front panel meter setup	34
		Configuring the basic setup parameters	34
		Communications setup	36
		Setting up serial communications	36
		Setting up Ethernet communications	37
		HMI settings	38
		Setting up the display	38
		Setting up regional settings	39
		Setting up the screen passwords	39
		Lost password	40
		Setting the clock	41
		Advanced setup	41
		Setting up the alarm / energy pulsing LED	42
		Input / output setup	43
		Demand setup	43
		Multi-tariff setup	44
		Alarms setup	44
		Remote Meter Setup	44
Chapter 5:	Viewing Meter Data	Viewing meter data from the front panel	45
		Meter data display screens	45

		Using ION Setup to view or modify configuration data	48
		Using software to view meter data	48
Chapter 6:	Input / Output	Status input applications	49
		Status input setup	50
		Digital output applications	52
		Digital output setup	52
		Relay output applications	57
		Relay output setup	57
		Alarm / energy pulsing LED setup	60
Chapter 7:	Alarms	About Alarms	63
		1-Second Alarms	63
		Digital Alarms	65
		Unary Alarms	66
		Alarm Priorities	66
		Using an Alarm to Control a Relay and Digital Output	66
		Alarm Setup	66
		Setting Up 1-Second Alarms	67
		Setting Up Unary Alarms	69
		Setting Up Digital Alarms	70
		Viewing Alarm Activity and History	72
		Viewing Active Alarms and Alarm Counters	72
		Viewing Unacknowledged Alarms and the Alarm History Log	73
Chapter 8:	Data Logs	Data Logs	75
		Memory Allocation for Log Files	76
		Alarm Log	76
		Alarm Log Storage	76
Chapter 9:	Measurements and calculations	Real-time readings	77
		Energy	77
		Min/max values	77
		Power factor	77
		Power factor min/max convention	78
		Power factor sign convention	78
		Demand	79
		Power demand calculation methods	79
		Current demand	81
		Predicted demand	81
		Peak demand	82
Chapter 10:	Multi-tariff feature	Multi-tariff feature example	83
		Multi-tariff feature overview	83
		Command mode overview	84
		Time of day mode overview	84
		Input mode overview	86
		Configuring tariffs using the front panel	87
		Configuring time of day mode tariffs using the front panel	87
		Configuring input mode tariffs using the front panel	88
Chapter 11:	Power quality	Harmonics overview	89
		Total Harmonic Distortion and Total Demand Distortion	89
		Displaying harmonics data	90
		Viewing harmonics using the front panel	90
		Viewing TDD	91
		Viewing THD/thd using the front panel	91

Chapter 12:	Verifying accuracy	Testing overview	93
		Accuracy test requirements	93
		Verifying accuracy test	95
		Energy pulsing considerations	97
		Test points	98
		Typical sources of test errors	98
Chapter 13:	Meter resets	Front panel meter reset screens	99
		Global resets	99
		Single resets	100
Chapter 14:	Maintenance and Upgrades	Password Recovery	103
		Power Meter Memory	103
		Identifying the Firmware Version, Model, and Serial Number	103
		Additional Meter Status Information	104
		Downloading Firmware	104
		Troubleshooting	105
		Heartbeat/Comms LED	105
		Getting Technical Support	106
		Register List	106
Chapter 15:	MID Compliance	MID overview	107
		MID compliance for the meter	107
		Specifications relevant to MID	107
		Safety precautions	108
		Installation and wiring	108
		Installing the terminal covers	109
		PM5331/PM5341 default screen	109
		Meter firmware version	110
		MID-protected setup parameters	110
		Lock-protected setup parameters	110
		Lock-protected functions	110
		Setting up the PM5331/PM5341	111
		Basic setup menu	111
		Advanced setup menu	111
		Clock setup menu	111
		Tariff setup menu	111
		Passwords setup menu	111
		Initializing the meter	111
		Locking or unlocking the meter	112
		Setting up lock password	112
	Glossary	Terms	113
		Abbreviations	115

Chapter 1—Introduction

This user guide explains how to operate and configure a PowerLogic™ PM5300 Series Power and Energy Meter.

Power and Energy Meter Hardware

Parts of the meter (rear view)

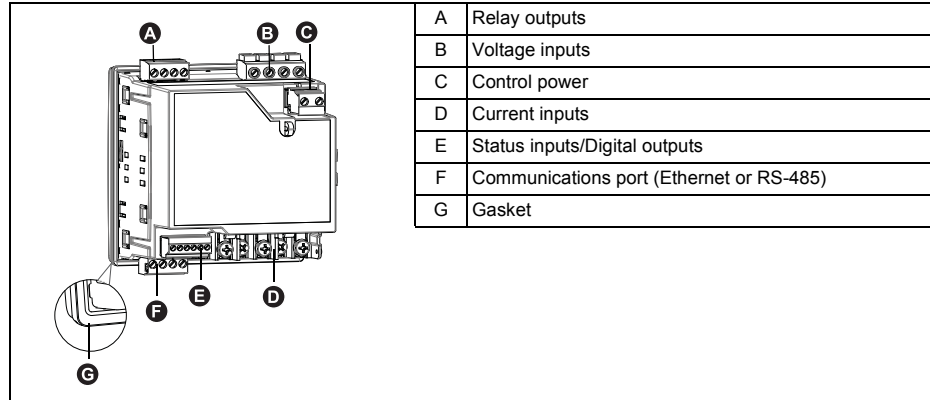

Parts and Accessories

Table 1– 1 Meter Models

Description	Model Numbers
Power and Energy meter with Integrated Display	PowerLogic™ PM5310, PM5330, PM5331, PM5320, PM5340, and PM5341

Box Contents

1. Power and Energy Meter (1)
2. Installation Guide (1)
3. Calibration Certificate (1)
4. Connectors
5. Retainer Clips (2)

Firmware

This user guide is written to be used with firmware version 01.00.0 and higher. See “Identifying the Firmware Version, Model, and Serial Number” on page 103 for instructions on determining the firmware version.

Chapter 2—Safety Precautions

Before You Begin

Installation, wiring, testing and service must be performed in accordance with all local and national electrical codes.

This section contains important safety precautions that must be followed before attempting to install, service, or maintain electrical equipment. Carefully read and follow the safety precautions outlined below.

⚠ DANGER

HAZARD OF ELECTRIC SHOCK, EXPLOSION, OR ARC FLASH

- Apply appropriate personal protective equipment (PPE) and follow safe electrical work practices. In the USA, see NFPA 70E or CSAZ462.
- Only qualified electrical workers should install this equipment. Such work should be performed only after reading this entire set of instructions.
- If the equipment is not used in a manner specified by the manufacturer, the protection provided by the equipment may be impaired.
- NEVER work alone.
- Before performing visual inspections, tests, or maintenance on this equipment, disconnect all sources of electric power. Assume that all circuits are live until they have been completely de-energized, tested, and tagged. Pay particular attention to the design of the power system. Consider all sources of power, including the possibility of back feeding.
- Turn off all power supplying the meter and the equipment in which it is installed before working on it.
- Always use a properly rated voltage sensing device to confirm that all power is off.
- Before closing all covers and doors, inspect the work area for tools and objects that may have been left inside the equipment.
- When removing or installing panels, do not allow them to extend into the energized bus.
- The successful operation of this equipment depends upon proper handling, installation, and operation. Neglecting fundamental installation requirements may lead to personal injury as well as damage to electrical equipment or other property.
- Before performing Dielectric (Hi-Pot) or Megger testing on any equipment in which the energy meter is installed, disconnect all input and output wires to the energy meter. High voltage testing may damage electronic components contained in the energy meter.
- This equipment should be installed in a suitable electrical enclosure.

Failure to follow these instructions will result in death or serious injury.

Notices

FCC PART 15 NOTICE

This equipment has been tested and found to comply with the limits for a Class B digital device, pursuant to part 15 of the FCC Rules. These limits are designed to provide reasonable protection against harmful interference in a residential installation. This equipment generates, uses, and can radiate radio frequency energy and, if not installed and used in accordance with the instructions, may cause harmful interference to radio communications. However, there is no guarantee that interference will not occur in a particular installation. If this equipment does cause harmful interference to radio or television reception, which can be determined by turning the equipment off and on, the user is encouraged to try to correct the interference by one or more of the following measures:

- Reorient or relocate the receiving antenna.
- Increase the separation between the equipment and receiver.
- Connect the equipment to an outlet on a circuit different from that to which the receiver is connected.
- Consult the dealer or an experienced radio/TV technician for help.

This Class B digital apparatus complies with Canadian ICES-003.

Chapter 3—Hardware Reference

This section supplements the meter's installation sheet and provides additional information about the meter's physical characteristics and capabilities.

Models, Features and Options

Table 3 –1: PM5300 Series - Models, Features and Options

Features and Options	PM5300 Series			
	PM5310	PM5320	PM5330 PM5331	PM5340 PM5341
Installation				
Fast installation, panel mount with integrated display	✓	✓	✓	✓
Accuracy	CI 0.5S	CI 0.5S	CI 0.5S	CI 0.5S
Display				
Backlit LCD, multilingual, bar graphs, 6 lines, 4 concurrent values	✓	✓	✓	✓
Power and energy metering				
3-phase voltage, current, power, demand, energy, frequency, power factor	✓	✓	✓	✓
Multi-tariff	4	4	4	4
Power quality analysis				
THD, thd, TDD	✓	✓	✓	✓
Harmonics, individual (odd) up to	31st	31st	31st	31st
I/Os and relays				
I/Os	2SI/2DO	2SI/2DO	2SI/2DO	2SI/2DO
Relays	0	0	2	2
Alarms and control				
Alarms	35	35	35	35
Set point response time, seconds	1	1	1	1
Single and multi-condition alarms	✓	✓	✓	✓
Communications				
Serial ports with modbus protocol	1	-	1	-
Ethernet port with Modbus TCP protocol	-	1	-	1
MID ready compliance, EN50470-1/3, Annex B and Annex D Class C			PM5331	PM5341

Functions and Characteristics

Table 3 –2: Functions and Characteristics

General	PM5300 Series
Use on LV and MV systems	✓
Basic metering with THD and min/max readings	✓
Instantaneous rms values	
Current (per phase and neutral)	✓
Voltage (total, per phase L-L and L-N)	✓

Frequency	✓
Real, reactive, and apparent power (Total and per phase)	Signed, Four Quadrant
True Power Factor (Total and per phase)	Signed, Four Quadrant
Displacement PF (Total and per phase)	Signed, Four Quadrant
% Unbalanced I, V L-N, V L-L	✓
Energy Values*	
Accumulated Active, Reactive and Apparent Energy	Received/Delivered; Net and absolute
Demand Values*	
Current average	Present, Last, Predicted, Peak, and Peak Date Time
Active power	Present, Last, Predicted, Peak, and Peak Date Time
Reactive power	Present, Last, Predicted, Peak, and Peak Date Time
Apparent power	Present, Last, Predicted, Peak, and Peak Date Time
Demand calculation (Sliding, fixed and rolling block, thermal methods)	✓
Synchronization of the measurement window to input, communication command or internal clock	✓
Settable Demand intervals	✓
Other Measurements*	
I/O timer	✓
Operating timer	✓
Load timer	✓
Alarm counters and alarm logs	✓
Power Quality Measurements	
THD, thd (Total Harmonic Distortion) I, V L-N, V L-L per phase	I, V L-N, V L-L
TDD (Total Demand Distortion)	✓
Individual harmonics (odds)	31st
Data Recording	
Min/max of instantaneous values, plus phase identification*	✓
Alarms with 1s timestamping*	✓
Data logging	Up to two fixed parameters (e.g., kWh and kVAh) with configurable interval and duration (e.g., 2 parameters for 60 days at 15 minutes interval)
Memory capacity	256 kB
Min/max log	✓
Maintenance, alarm and event logs	✓
Inputs/Outputs/Relays	
Digital inputs	2
Digital outputs	2
Form A Relay outputs	2
Timestamp resolution in seconds	1
Whetting voltage	✓

NOTE: *Stored in non-volatile memory

Technical Specifications

Electrical Characteristics	
Type of measurement: True rms on three-phase (3P, 3P + N), zero blind	64 samples per cycle
Measurement accuracy	
IEC 61557-12 ¹	PMD/[SD]SS/K70/0.5
Active Energy ²	Class 0.5S as per IEC 62053-22
Reactive Energy ²	Class 2S as per IEC 62053-23
Active Power	Class 0.5 as per IEC 61557-12 ¹
Reactive Power	Class 2 as per IEC 61557-12 ¹
Apparent Power	Class 0.5 as per IEC 61557-12 ¹
Current, Phase	Class 0.5 as per IEC 61557-12 ¹
Voltage, L-N	Class 0.5 as per IEC 61557-12 ¹
Frequency	Class 0.05 as per IEC 61557-12 ¹
Power Factor	Class 0.5 as per IEC 61557-12 ¹
Voltage Harmonics	Class 5 as per IEC 61557-12 ¹
Voltage THD/thd	Class 5 as per IEC 61557-12 ¹
Current Harmonics	Class 5 as per IEC 61557-12 ¹
Current THD/thd	Class 5 as per IEC 61557-12 ¹
MID Directive (2004/22/EC)	Annex B and Annex D (PM5331 and PM5341) Class C
Input-voltage (up to 1.0 MV AC max, with voltage transformer)	
Nominal Measured Voltage range	UL: 20-347 V L-N/35-600 V L-L IEC: 20-400 V L-N/35-690 V L-L (absolute range 35 V L-L to 760 V L-L)
Impedance	5 M Ω
F nom	50/60 Hz
Input-current (configurable for 1 or 5 A secondary CTs)	
I nom	5 A
Measured Amps with over range and Crest Factor	Starting current: 5mA Operating range: 50mA to 8.5A
Withstand	Continuous 20 A, 10s/hr 50 A, 1s/hr 500 A
Impedance	< 0.3 m Ω
F nom	50/60 Hz
Burden	<0.026VA at 8.5A
Frequency measurement	
Measurement range	45 to 65 Hz
AC control power	
Operating range	100 - 277 V AC L-N / 415 V L-L +/-10% CAT III 300V class per IEC 61010
Burden	<5 W, 11 VA at 415V L-L
Frequency	45 to 65 Hz
Ride-through time	80 mS typical at 120V AC and maximum burden. 100 mS typical at 230 V AC and maximum burden 100 mS typical at 415 V AC and maximum burden
DC control power	
Operating range	125-250 V DC \pm 20%
Burden	<4 W at 250 V DC
Ride-through time	50 mS typical at 125 V DC and maximum burden
Outputs	
Mechanical	
Max output frequency	0.5 Hz maximum (1 second ON / 1 second OFF - minimum times)
Switching current	250 V AC at 8.0 Amps, 25 k cycles, resistive 30 V DC at 2.0 Amps, 75 k cycles, resistive 30 V DC at 5.0 Amps, 12.5 k cycles, resistive
Isolation	2.5 kV rms
Digital outputs	
Max load voltage	40 V DC
Max load current	20 mA
On Resistance	50 Ω max

Meter constant	from 1 to 9,999,999 pulses per k _h (k _h = kWh, kVARh or kVAh depending on the energy parameter selected)
Pulse width for Digital Output	50% duty cycle
Pulse frequency for Digital Output	25 Hz max.
Leakage current	0.03 micro Amps
Isolation	5 kV rms
Optical outputs	
Pulse width (LED)	200 μs
Pulse frequency	50 Hz. max.
Meter constant	from 1 to 9,999,999 pulses per k _h
Status Inputs	
ON Voltage	18.5 to 36 V DC
OFF Voltage	0 to 4 V DC
Input Resistance	110 k Ω
Maximum Frequency	2 Hz (T ON min = T OFF min = 250 ms)
Response Time	20 ms
Opto Isolation	5 kV rms
Whetting output	24 V DC/ 8mA max
Input Burden	2 mA @ 24 V DC
Mechanical Characteristics	
Product weight	430 g
IP degree of protection (IEC 60529)	IP52 front display, IP30 meter body
Dimensions W x H x D [protrusion from cabinet]	96 x 96 x 72mm (depth of meter from housing mounting flange) [13mm]
Mounting position	Vertical
Panel thickness	6 mm maximum
Environmental Characteristics	
Operating temperature	
Meter	-25 °C to +70 °C
Display (Display functions to -25° with reduced performance)	-25 °C to +70 °C
Storage temp.	-40 °C to +85 °C
Humidity range	5 to 95 % RH at 50 °C (non-condensing)
Pollution degree	2
Altitude	2000 m CAT III / 3000 m CAT II
For indoor use only	
Electromagnetic Compatibility ³	
Electrostatic discharge	IEC 61000-4-2
Immunity to radiated fields	IEC 61000-4-3
Immunity to fast transients	IEC 61000-4-4
Immunity to surge	IEC 61000-4-5
Conducted immunity 150kHz to 80MHz	IEC 61000-4-6
Immunity to magnetic fields	IEC 61000-4-8
Immunity to voltage dips	IEC 61000-4-11
Radiated emissions	FCC part 15, EN 55022 Class B
Conducted emissions	FCC part 15, EN 55022 Class B
Safety	
Europe	CE, as per IEC 61010-1 (3rd Edition), IEC 62052-11 & IEC61557-12 ¹
U.S. and Canada	cULus as per UL61010-1 (3rd Edition) CAN/CSA-C22.2 No. 61010-1 (3rd Edition)
Measurement category (Voltage and Current inputs)	CAT III up to 400 V L-N / 690 V L-L
Dielectric	As per IEC/UL 61010-1 (3rd Edition)
Protective Class	II, Double insulated for user accessible parts
Communication	
RS-485 port Modbus RTU, Modbus ASCII (7 or 8 bit), JBUS	2-Wire, 9600,19200 or 38400 baud, Parity - Even, Odd, None, 1 stop bit if parity Odd or Even, 2 stop bits if None; (Optional)
Ethernet port: 10/100 Mbps; Modbus TCP/IP	1 (Optional)
Firmware and language file update	Meter firmware update via the communication ports

Isolation	2.5 kVrms, double insulated
Human Machine Interface	
Display type	Monochrome Graphics LCD
Resolution	128 x 128
Backlight	White LED
Viewable area (W x H)	67 x 62.5 mm
Keypad	4-button
Indicator Heartbeat / Comm activity	Green LED
Energy pulse output / Active alarm indication (configurable)	Optical, amber LED
Wavelength	590 to 635 nm
Maximum pulse rate	2.5 kHz

¹ For firmware version 1.1.1 and higher

² For 1A nominal CT when I > 0.15A

³ Tests are conducted as per IEC 61557-12 (IEC 61326-1), 62052-11 and EN50470

Before you begin

Carefully read and follow the safety precautions before working with the meter.

Safety precautions

Installation, wiring, testing and service must be performed in accordance with all local and national electrical codes.

⚠ DANGER

HAZARD OF ELECTRIC SHOCK, EXPLOSION OR ARC FLASH

- Apply appropriate personal protective equipment (PPE) and follow safe electrical work practices. See NFPA 70E in the USA or applicable local standards.
- Turn off all power supplying this device before working on it.
- Always use a properly rated voltage sensing device to confirm that all power is off.
- Do not exceed the device’s ratings for maximum limits.
- Always use grounded external CTs for current inputs.

Failure to follow these instructions will result in death or serious injury.

1. Turn off all power supplying this device before working on it.
2. Always use a properly rated voltage sensing device to confirm that all power is off.

Dimension

Figure 3–1: Dimension

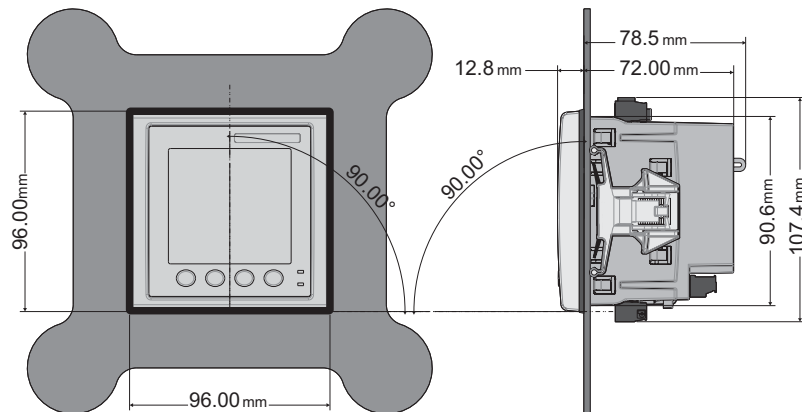

Meter mounting

This section describes how to mount the meter.

Mounting the PM5300

The meter is designed to be mounted inside a 1/4-DIN panel cutout.

1. Inspect the gasket (installed around the perimeter of the front display) and make sure it is secured properly and not damaged.

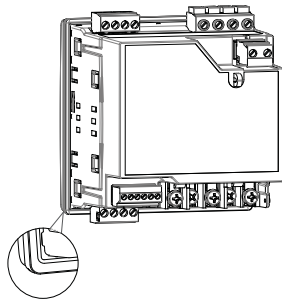

2. Insert the meter through the mounting hole.

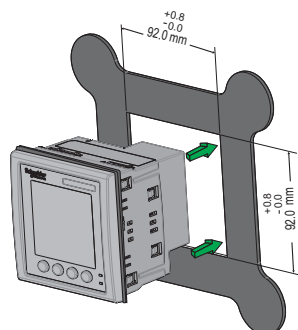

3. Line up the tabs of the retainer clips with the slots on either side of the meter. While holding the retainers at a slight angle, push the retainers in and forward to position them in place. In situations where the spacing between meters is tight, use a flat-head screwdriver with a long, narrow shaft to help secure the clips.

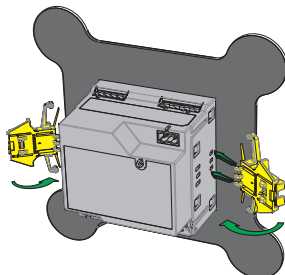

4. Push the middle of the clip assembly to lock the retainer in place and secure the meter.

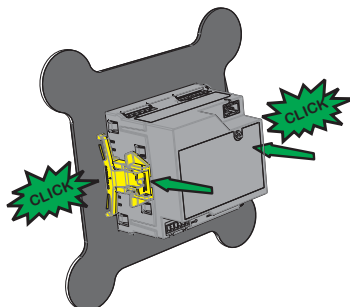

Meter wiring

For wiring instructions and safety precautions, see the meter installation sheet that was shipped with your meter, or download a copy at www.schneider-electric.com.

- Wire connections to the meter's voltage inputs, control power, digital outputs, digital (status) inputs and RS-485 communications are terminated using the supplied pluggable wire connectors.
- When wiring the meter's current inputs, terminate the wire ends with ring or split-ring crimp connectors.

Use the meter installation sheet when wiring the meter.

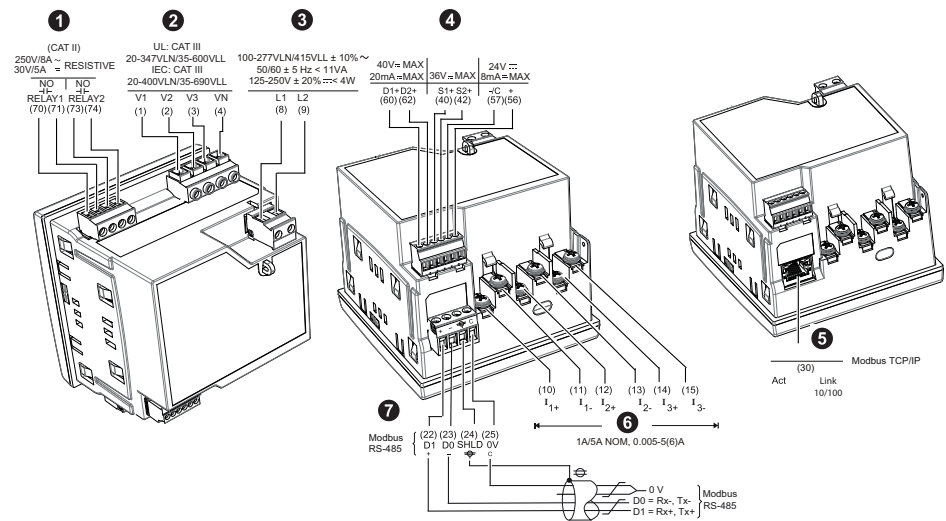

Serial No.	Description	Specification
1	Relay (Relay1, Relay2)	<ul style="list-style-type: none"> • Wire size: 0.33 - 3.31 mm² (22 - 12 AWG) • Wire strip length: 0.24 in (6 mm) • Torque: 0.5 - 0.6 N·m (4.4 - 5.3 in·lb) • Screw driver type: M3
2	Voltage Inputs (V1, V2, V3, VN)	<ul style="list-style-type: none"> • Wire size: 0.82 - 3.31 mm² (18 - 12 AWG) • Wire strip length: 0.28 in (7 mm) • Torque: 0.5 - 0.6 N·m (4.4 - 5.3 in·lb) • Screw driver type: M3
3	Control Power (L1, L2)	<ul style="list-style-type: none"> • Wire size: 0.82 - 3.31 mm² (18 - 12 AWG) • Wire strip length: 0.28 in (7 mm) • Torque: 0.5 - 0.6 N·m (4.4 - 5.3 in·lb) • Screw driver type: M3
4	Digital Output / Status Input (D1+, D2+, S1+, S2+, -C, +)	<ul style="list-style-type: none"> • Wire size: 0.33 - 3.31 mm² (22 - 12 AWG) • Wire strip length: 0.24 in (6 mm) • Torque: 0.5 - 0.6 N·m (4.4 - 5.3 in·lb) • Screw driver type: M2
5	Current Inputs (I1+, I1-, I2+, I2-, I3+, I3-)	<ul style="list-style-type: none"> • Wire size: 0.82 - 3.31 mm² (18 - 12 AWG) • Wire strip length: 0.28 in (7 mm) • Torque: 0.9 - 1.0 N·m (8.0 - 9.0 in·lb) • Screw driver type: PH1
6	Ethernet	RJ-45
7	Modbus RS-485 (+, -, Ⓢ, C)	<ul style="list-style-type: none"> • Wire size: 0.33 - 3.31 mm² (22 - 12 AWG) • Wire strip length: 0.24 in (6 mm) • Torque: 0.5 - 0.6 N·m (4.4 - 5.3 in·lb) • Screw driver type: M3

Recommended cables

Communication	Make	Part code	Description
RS-485	Belden	3105A	Multi-Conductor - EIA Industrial RS-485 PLTC/CM
		3106A	Multi-Conductor - EIA Industrial RS-485 PLTC/CM
Ethernet	Schneider Electric	DC6PCSRJ01-GY	DIGILINK Patch Cord CAT at 6 SFTP Gray 1m
		DC6PCSRJ02-GY	DIGILINK Patch Cord CAT 6 SFTP Gray 2m
		DC6PCSRJ03-GY	DIGILINK Patch Cord CAT 6 SFTP Gray 3m
		DCECASTP4P3X	DIGILINK Solid Cable CAT 5e, 4 pair, SFTP-305m

NOTE: According to Blondel's theorem, in an N wire system a minimum of N-1 measuring elements are required for correct measurement.



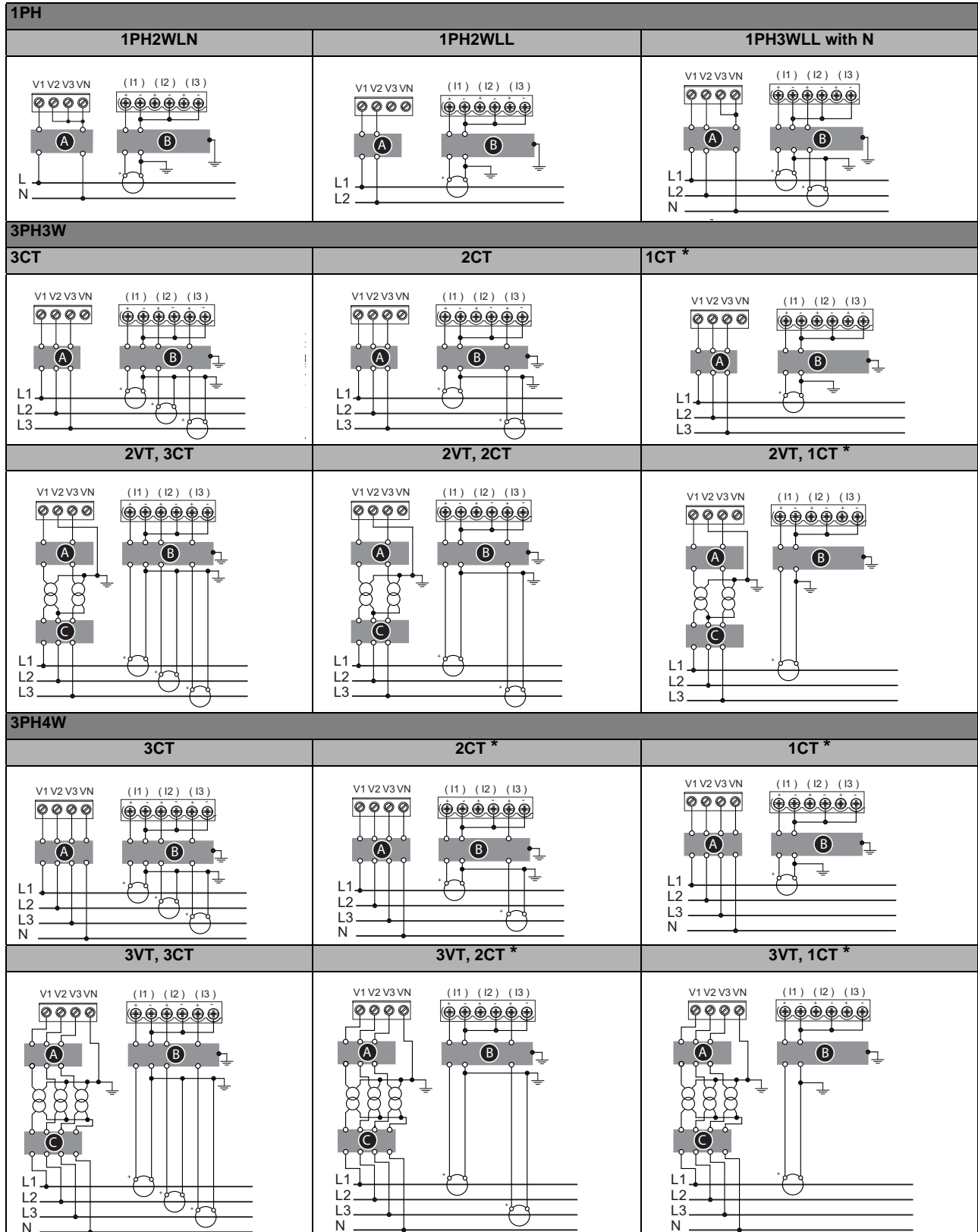



Wiring Diagrams



Symbol	Description
A	500 mA fused disconnect / circuit breaker (not supplied)
B	Shorting block (not supplied)
C	PT primary fuses and disconnect switch (not supplied)
*	Indicates wiring for a balanced system

NOTE:

- Clearly label the device’s disconnect circuit mechanism and install it within easy reach of the operator.
- The fuses / circuit breakers must be rated for the installation voltage and sized for the available fault current.
- Fuse for neutral terminal is required if the source neutral connection is not grounded.

	Potential Transformer	Current Transformer	Voltage disconnect switch	
IEC				
ANSI				

Power system

This section outlines typical requirements for wiring the voltage and current inputs of the meter to the electrical power system.



For wiring instructions and safety precautions, see the meter installation sheet that was shipped with your meter, or download a copy at www.schneider-electric.com.

Direct connect voltage limits

You can connect the meter’s voltage inputs directly to the phase voltage lines of the power system if the power system’s line-to-line or line-to-neutral voltages do not exceed the meter’s direct connect maximum voltage limits. The meter’s voltage measurement inputs are rated by the manufacturer for up to 400 V L-N / 690 V L-L. However, the maximum voltage allowed for direct connection may be lower, depending on the local electrical codes and regulations. In US and Canada the maximum voltage on the meter voltage measurement inputs may not exceed 347 V L-N / 600 V L-L.

If your system voltage is greater than the specified direct connect maximum voltage, you must use VTs (voltage transformers) to step down the voltages.

Power system setup parameters

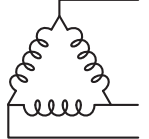
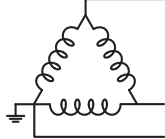
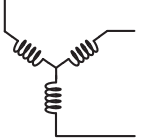
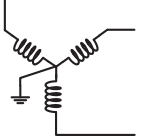
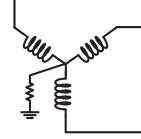
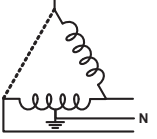
Power system description — Meter setting	Symbol	Direct connect maximum		# of VTs (if required)
		UL	IEC	
Single-phase 2-wire line-to-neutral — 1PH2W LN		347 V L-N	400 V L-N	1 VT
Single-phase 2-wire line-to-line — 1PH2W LL		600 V L-L	600 V L-L	1VT
Single-phase 3-wire line-to-line with neutral — 1PH3W LL with N		347 V L-N / 600 V L-L	400 V L-N / 690 V L-L	2VT
3-phase 3-wire Delta ungrounded — 3PH3W Dlt Ungnd		600 V L-L	600 V L-L	2 VT
3-phase 3-wire Delta corner grounded — 3PH3W Dlt Cmr Gnd		600 V L-L	600 V L-L	2 VT
3-phase 3-wire Wye ungrounded — 3PH3W Wye Ungnd		600 V L-L	600 V L-L	2 VT
3-phase 3-wire Wye grounded — 3PH3W Wye Gnd		600 V L-L	600 V L-L	2 VT
3-phase 3-wire Wye resistance-grounded — 3PH3W Wye Res Gnd		600 V L-L	600 V L-L	2 VT
3-phase 4-wire open Delta center-tapped — 3PH4W Opn Dlt Ctr Tp		240 V L-N / 415 V L-N / 480 V L-L	240 V L-N / 415 V L-N / 480 V L-L	3 VT

Power system setup parameters *(continued)*

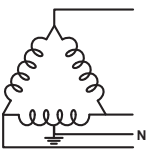
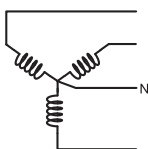
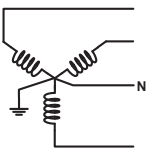
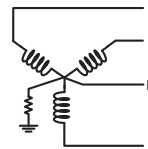
Power system description — Meter setting	Symbol	Direct connect maximum		# of VTs (if required)
		UL	IEC	
3-phase 4-wire Delta center-tapped — 3PH4W Dlt Ctr Tp		240 V L-N / 415 V L-N / 480 V L-L	240 V L-N / 415 V L-N / 480 V L-L	3 VT
3-phase 4-wire ungrounded Wye — 3PH4W Wye Ungnd		347 V L-N / 600 V L-L	347 V L-N / 600 V L-L	3 VT or 2 VT
3-phase 4-wire grounded Wye — 3PH4W Wye Gnd		347 V L-N / 600 V L-L	400 V L-N / 690 V L-L	3 VT or 2 VT
3-phase 4-wire resistance-grounded Wye — 3PH4W Wye Res Gnd		347 V L-N / 600 V L-L	347 V L-N / 600 V L-L	3 VT or 2 VT

Voltage and current input wiring

For wiring instructions and safety precautions, see the meter installation sheet that was shipped with your meter, or download a copy at www.schneider-electric.com.

Voltage input protection

The meter’s voltage inputs must be wired to fuses/breakers and a disconnect switch. If using a voltage transformer (VT), both primary and secondary sides of the VT must be wired to fuses/breakers and disconnect switches.

- Clearly label the device’s disconnect circuit mechanism and install it within easy reach of the operator.
- The fuses / circuit breakers must be rated for the installation voltage and sized for the available fault current.
- Fuse for neutral terminal is required if the source neutral connection is not grounded.

See the meter installation sheet for fuse ratings.

Current input protection

For all connected current inputs, use a CT shorting block to short-circuit the secondary leads of the CTs before removing the current input connections to the meter.

NOTE: Ground any unused current inputs.

Balanced system considerations

In situations where you are monitoring a balanced 3-phase load, you may choose to connect only one or two CTs on the phase(s) you want to measure, and then configure the meter so it calculates the current on the unconnected current input(s).

NOTE: For a balanced 4-wire Wye system, the meter's calculations assume that there is no current flowing through the neutral conductor.

Balanced 3-phase Wye system with 2 CTs

The current for the unconnected current input is calculated so that the vector sum for all three phase currents equal zero.

Balanced 3-phase Wye or Delta system with 1 CT

The currents for the unconnected current inputs are calculated so that their magnitude and phase angle are identical and equally distributed, and the vector sum for all three phase currents equal zero.

NOTE: You must always use 3 CTs for 3-phase 4-wire center-tapped Delta or center-tapped open Delta systems.

Control power wiring

For wiring instructions and safety precautions, see the meter installation sheet that was shipped with your meter, or download a copy at www.schneider-electric.com.

The meter can be powered from an AC or DC power source.

- L1 and L2 are non-polarized. If using an AC power supply with neutral, connect neutral to the meter's L2 terminal.
- Always use a fuse on L1. Fuse L2 when connecting an ungrounded neutral to the control power.
- If using a control power transformer, fuse both primary and secondary sides of the transformer.
- The fuses / circuit breakers must be rated for the installation voltage and sized for the available fault current.

Communications

This section provides additional information about the communications ports and topologies supported by the meter. You must wire and configure the RS-485 port or the Ethernet port in order to communicate with the meter.

Serial communications

The meter supports serial communications through the RS-485 port. Up to 32 devices can be connected on a single RS-485 bus.

In an RS-485 network, there is one master device, typically an Ethernet to RS-485 gateway. It provides the means for RS-485 communications with multiple slave devices (for example, meters). For applications that require only one dedicated computer to

communicate with the slave devices, an RS-232 to RS-485 converter can be used as the master device.

RS-485 wiring

Connect the devices on the RS-485 bus in a point-to-point configuration, with the (+) and (-) terminals from one device connected to the corresponding (+) and (-) terminals on the next device.

RS-485 wiring

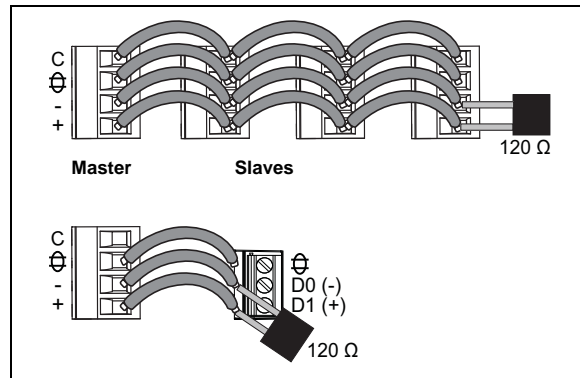

RS-485 cable

Use a shielded 1.5 twisted pair or 2 twisted pair RS-485 cable to wire the devices. Use one twisted pair to connect the (+) and (-) terminals, and use the other insulated wire to connect the C terminals.

RS-485 terminals

C	Common. This provides the voltage reference (zero volts) for the data plus and data minus signals.
⊕	Shield. Connect the bare wire to this terminal to help suppress signal noise that may be present. Ground the shield wiring at one end only (either at the master or the last slave device, but not both).
-	Data minus. This transmits/receives the inverting data signals.
+	Data plus. This transmits/receives the non-inverting data signal.

RS-485 maximum cable length

The total distance for devices connected on an RS-485 bus should not exceed 1200 m (4000 ft).

RS-485 network configuration

After you have wired the RS-485 port and powered up the meter, you must configure the serial communications port in order to communicate with the meter.

Each device on the same RS-485 communications bus must have a unique address and all connected devices must be set to the same protocol, baud rate, and parity (data format).

NOTE: To communicate with the meter using ION Setup, you must set the parity to “None” for all devices in the RS-485 network.

For meters that do not have a display, you must first wire and configure each one separately before connecting these meters to the same RS-485 bus.

Related topics

- To configure RS-485 communications, see “Setting up serial communications” on page 36.

Ethernet communications

The meter uses Modbus TCP protocol to communicate at data speeds up to 100 Mbps through its Ethernet communications port.

Use a shielded Ethernet cable to connect the meter’s Ethernet port. Ground terminal is not available on meter, shield should be connected to Ground at the other end. Ethernet connection source should be installed in a location that minimizes the overall Ethernet cable routing length.

Ethernet wiring

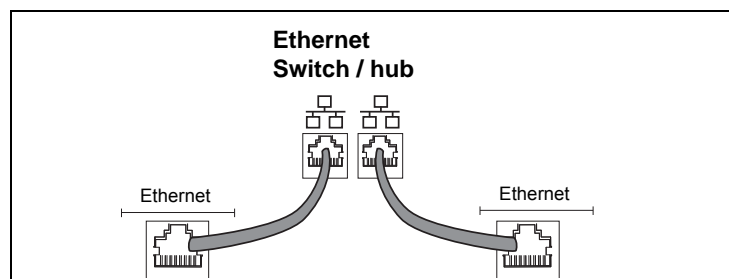

Ethernet configuration

To communicate with the meter through Ethernet, all devices must have a unique IP address and be set to the same subnet mask and gateway.

- To configure Ethernet communications, see “Setting up Ethernet communications” on page 37.

Digital outputs

The meter is equipped with two digital output ports (D1, D2). You can configure the digital outputs for use in the following applications:

- switching applications, for example, to provide on/off control signals for switching capacitor banks, generators, and other external devices and equipment
- demand synchronization applications, where the meter provides pulse signals to the input of another meter to control its demand period
- energy pulsing applications, where a receiving device determines energy usage by counting the k_h pulses (k_h = kWh, kVARh or kVAh depending on the energy parameter selected) coming from the meter’s digital output port

The digital outputs can handle voltages less than 40 V DC. For higher voltage applications, use an external relay in the switching circuit.

Digital output connections

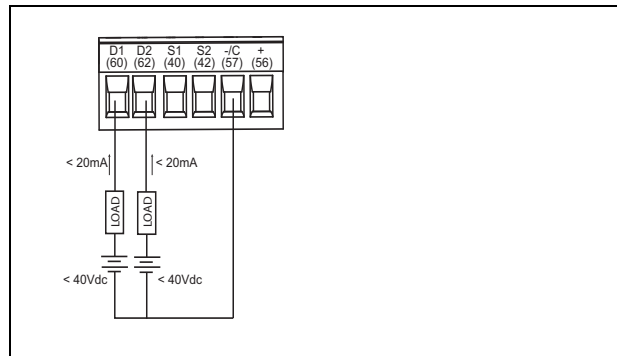

Related topics

- See “Digital output applications” on page 52 for digital output use and configuration details.

Status inputs

The meter is equipped with two status input ports (S1 and S2). You can configure the status inputs for use in status monitoring applications.

The meter’s status inputs require an external voltage source to detect the status input’s on/off state. The meter detects an ON state if the external voltage appearing at the status input is within its operating range.

The external voltage can be derived from either the whetting output provided by the meter or by a voltage source up to 36 V DC external to the meter.

Status input connections

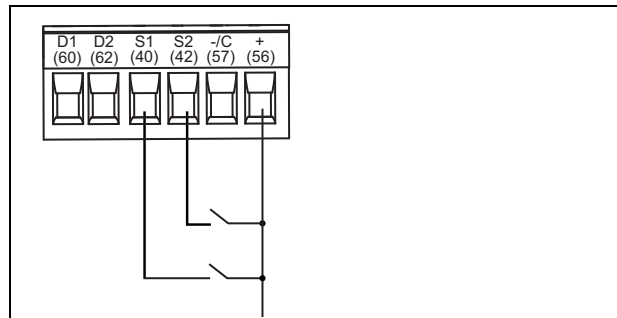

Relay outputs

The meter is equipped with two Form A mechanical relay output ports (Relay 1 and Relay 2). Relay outputs can be configured to be used switching applications, for example, to provide on/off control signals for switching capacitor banks, generators, and other external devices and equipment.

Relay output connections

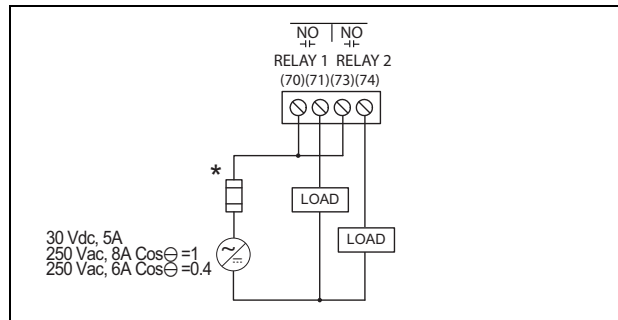

* The overcurrent protective device must be rated for the short-circuit current at the connection point.

Chapter 4—Front panel display and meter setup

The front panel display lets you use the meter to perform various tasks such as setting up the meter, displaying data screens, acknowledging alarms, or performing resets.

Parts of the display

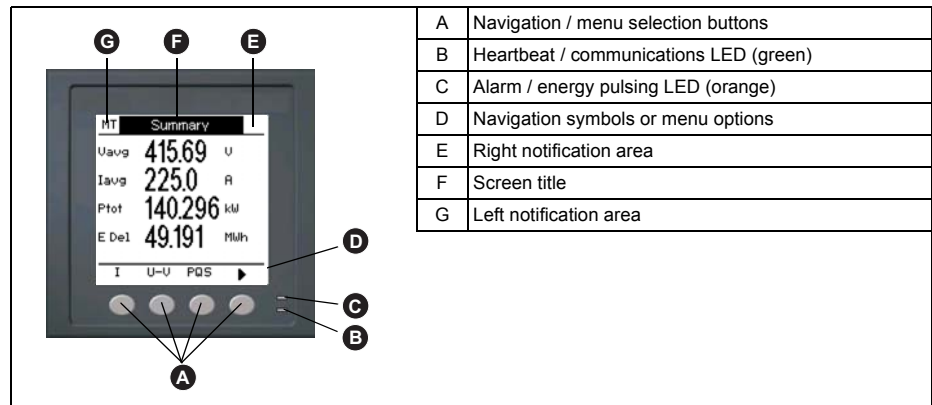

LED indicators

The meter has two LED indicators on the front panel.

Front panel LEDs

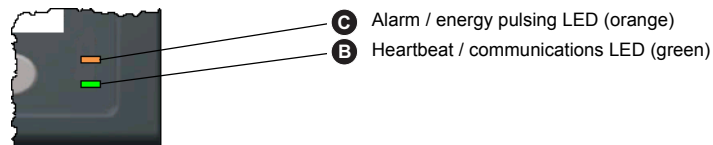

Heartbeat / communications LED

The (green) heartbeat / communications LED blinks at a slow, steady rate to indicate the meter is operational. The LED flashes at a variable, faster rate when the meter is communicating over a Modbus serial communications port.

You cannot configure this LED for other purposes.

NOTE: A heartbeat LED that remains lit and does not blink (or flash) indicates a possible hardware problem. Please contact Technical Support.

Alarm / energy pulsing LED modes

The (orange) alarm / energy pulsing LED can be configured for alarm notification or energy pulsing.

- When configured for alarm notification, this LED flashes when a high, medium or low priority alarm is active. This provides a visual indication of an active alarm condition, or an inactive but unacknowledged high priority alarm.
- When configured for energy pulsing, this LED flashes at a rate proportional to the amount of energy consumed. This is typically used to verify the meter's accuracy.



Related topics

- See “Setting up the alarm / energy pulsing LED” on page 42 for details on using the front panel to switch the LED mode for alarming or energy pulsing applications.
- See “Alarm / energy pulsing LED setup” on page 60 for details on using ION Setup to switch the LED mode for alarming or energy pulsing applications.
- See “Alarm Priorities” on page 66 for a detailed description on the alarm / energy pulsing LED’s behavior when it is configured for alarm notification.

Notification icons

To alert you about meter state or events, notification icons appear at the top left or top right corner of the display screen.

Notification icons

Icon	Description
	The wrench icon indicates that the power meter requires maintenance. See “Maintenance and Troubleshooting” on page 103.
	The alarm icon indicates an alarm condition has occurred. See “About Alarms” on page 63 and “Alarm Priorities” on page 66.
	The blinking heartbeat icon indicates that the power meter is in normal operating condition.

Meter screen menus

All meter screens are grouped logically, according to their function. You can access any available meter screen by first selecting the Level 1 (top level) screen that contains it.

Level 1 screen menus - IEEE display mode

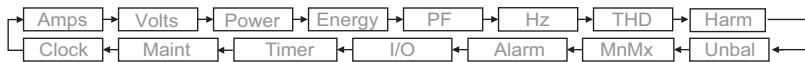



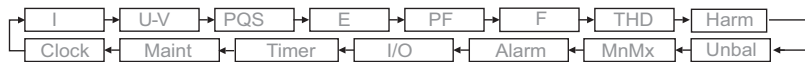





Level 1 screen menus - IEC display mode



Use the buttons to navigate the different meter screens. The navigation symbols and their functions are explained below:

Navigation symbols

Symbol	Description
	Scroll right and display more menu items
	Exit screen and go up one level
	Move cursor down the list of options or display more items below
	Move cursor up the list of options or display more items above
	Move cursor one character to the left
	Increase the highlighted value or show the next item in the list
	Show the previous item in the list
	Front panel buttons

When you reach the last screen, press  again to cycle through the screen menus.

Menu tree

This summarizes the meter screens (IEEE menus shown, with the corresponding IEC menus in parentheses — see “Setting up regional settings” on page 39).

PM5300 display screen menus

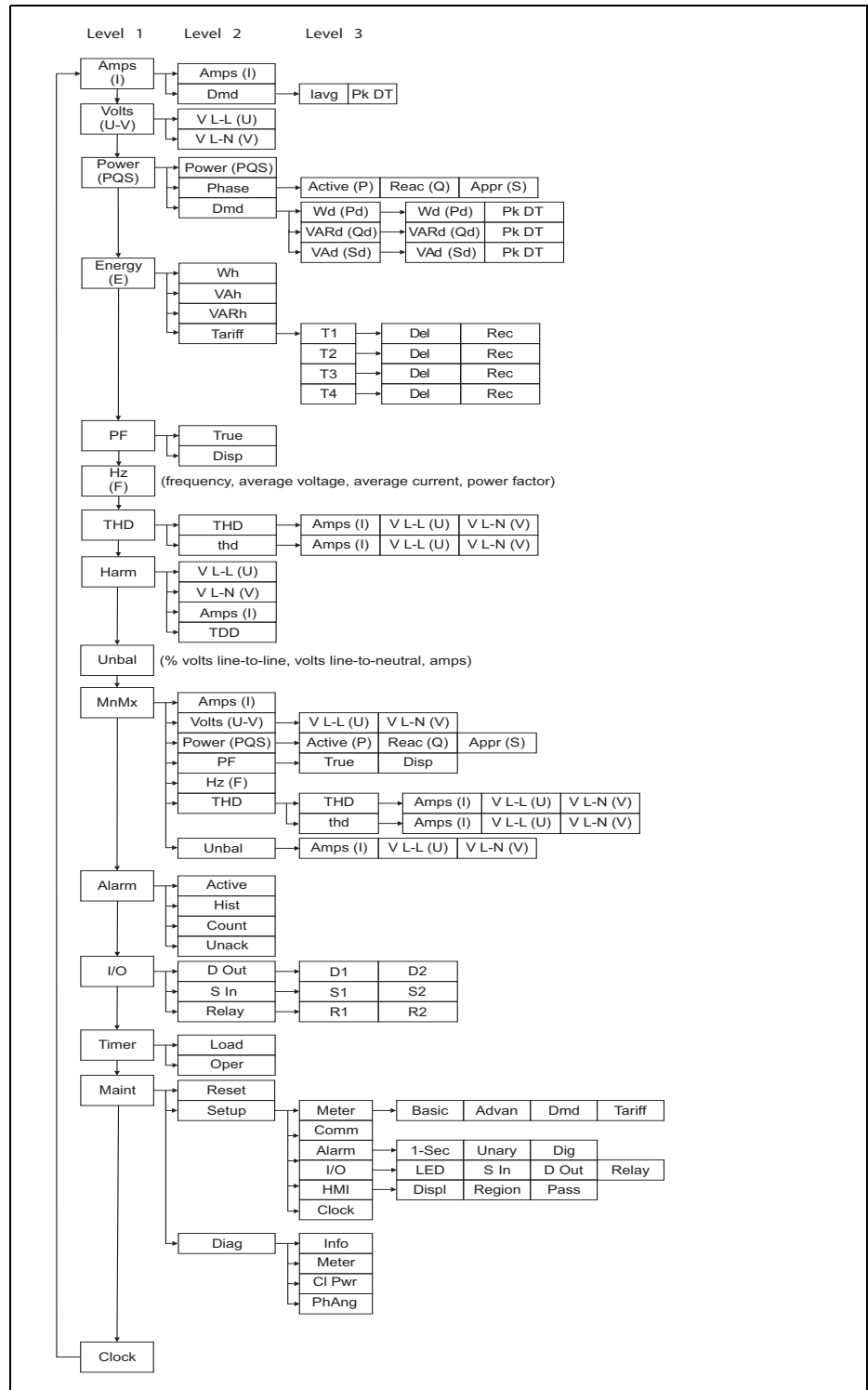

Meter setup screen navigation

The meter's front panel buttons and display screen allow you to navigate and configure the meter's setup parameters. The following illustration shows one of the meter setup screens.

Basic setup screen

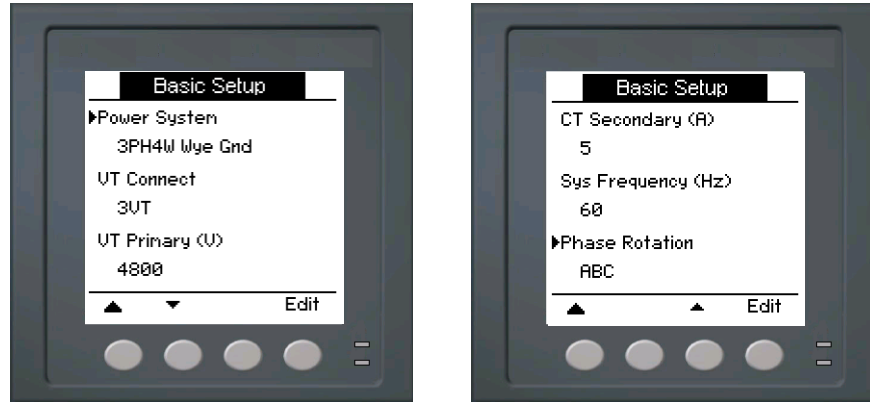

In this example, the down arrow (▼) indicates there are more parameters below the selected option (▶). Press the down arrow button to display additional parameters. The down arrow disappears when the last item in the list is selected, and there are no more parameters to display.

Front panel meter setup

Meter configuration can be performed directly through the front panel buttons or remotely through software. This section contains instructions on setting up the meter using the front panel.

Related topics

- See “Remote Meter Setup” on page 44 for remote meter setup details.

Configuring the basic setup parameters

Proper configuration of the meter's basic setup parameters is essential for accurate measurement and calculations. Use the Basic Setup screen to define the electrical power system that the meter is monitoring.

NOTICE

UNINTENDED EQUIPMENT OPERATION

After modifying any basic setup parameter:

- Verify all standard alarms settings are correct and make adjustments as necessary.
- Re-enable all configured alarms.

Failure to follow these instructions can result in incorrect alarm functions.

If standard (1-sec) alarms have been configured and you make subsequent changes to the meter's basic setup, all alarms are disabled to prevent undesired alarm operation. After saving the changes, confirm all configured standard alarm settings are still valid, reconfigure them as required, and re-enable the alarms.

Basic setup menu tree

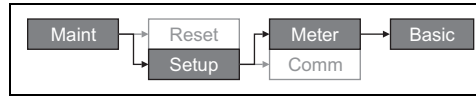

1. Navigate to **Maint > Setup**.
2. Enter the setup password (default is “0000”), then press **OK**.
3. Navigate to **Meter > Basic**.
4. Move the cursor to point to the parameter you want to modify, then press **Edit**.
5. Modify the parameter as required, then press **OK**.
6. Move the cursor to point to the next parameter you want to modify, press **Edit**, make your changes, then press **OK**.

Basic setup parameters

Parameter	Values	Description
Power System	Select the power system type (power transformer) the meter is wired to.	
	1PH2W LN	Single-phase 2-wire line-to-neutral
	1PH2W LL	Single-phase 2-wire line-to-line
	1PH3W LL with N	Single-phase 3-wire line-to-line with neutral
	3PH3W Dlt Ungnd	3-phase 3-wire ungrounded delta
	3PH3W Dlt Cmr Gnd	3-phase 3-wire corner grounded delta
	3PH3W Wye Ungnd	3-phase 3-wire ungrounded wye
	3PH3W Wye Gnd	3-phase 3-wire grounded wye
	3PH3W Wye Res Gnd	3-phase 3-wire resistance-grounded wye
	3PH4W Opn Dlt Ctr Tp	3-phase 4-wire center-tapped open delta
	3PH4W Dlt Ctr Tp	3-phase 4-wire center-tapped delta
	3PH4W Wye Ungnd	3-phase 4-wire ungrounded wye
	3PH4W Wye Gnd	3-phase 4-wire grounded wye
	3PH4W Wye Res Gnd	3-phase 4-wire resistance-grounded wye
VT Connect	Select how many voltage transformers (VT) are connected to the electrical power system.	
	Direct Con	Direct connect; no VTs used
	2VT	2 voltage transformers
	3VT	3 voltage transformers
VT Primary (V)	1 to 1000000	Enter the size of the VT primary, in Volts.
VT Secondary (V)	100, 110, 115, 120	Select the size of the VT secondary, in Volts
CT on Terminal	Define how many current transformers (CT) are connected to the meter, and which terminals they are connected to.	
	I1	1 CT connected to I1 terminal
	I2	1 CT connected to I2 terminal
	I3	1 CT connected to I3 terminal
	I1 I2	2 CT connected to I1, I2 terminals
	I1 I3	2 CT connected to I1, I3 terminals
	I2 I3	2 CT connected to I2, I3 terminals
	I1 I2 I3	3 CT connected to I1, I2, I3 terminals
CT Primary (A)	1 to 32767	Enter the size of the CT primary, in Amps.
CT Secondary (A)	1, 5	Select the size of the CT secondary, in Amps.
Sys Frequency (Hz)	50, 60	Select the frequency of the electrical power system, in Hz.
Phase Rotation	ABC, CBA	Select the phase rotation of the 3-phase system.

7. Press **▲** to exit. Press **Yes** to save your changes.

Related topics

- See “Configuring the basic setup parameters” on page 34 for meter basic setup instructions.

Communications setup

After wiring the meter’s serial and Ethernet communications ports, you can configure these ports so you can connect to the meter remotely and use device configuration software such as ION Setup to configure the meter.

Based on the reference model, the meter is equipped with the following communication ports:

Communication ports

Reference Models	Communication
PM5310	RS-485
PM5320	Ethernet
PM5330	RS-485
PM5331	RS-485
PM5340	Ethernet
PM5341	Ethernet

Setting up serial communications

The Serial Port setup screen allows you to configure the meter’s RS-485 communications port so you can use software to access the meter’s data or configure the meter remotely.

Serial communications setup menu tree

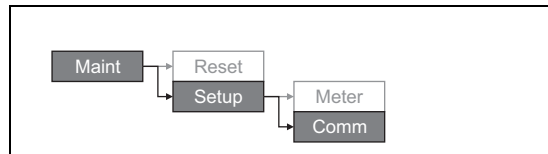

1. Navigate to **Maint > Setup**.
2. Enter the setup password (default is “0000”), then press **OK**.
3. Press **Comm**.
4. Move the cursor to point to the parameter you want to modify, then press **Edit**.
5. Modify the parameter as required, then press **OK**.
6. Move the cursor to point to the next parameter you want to modify, press **Edit**, make your changes, then press **OK**.

Communications setup parameters

Parameter	Values	Description
Protocol	Modbus	The communications format used to transmit data. The protocol must be the same for all devices in a communications loop.
Address	1 to 247	Set the address for this device. The address must be unique for each device in a communications loop. For Jbus protocol, set the device ID to 255.
Baud Rate	9600, 19200, 38400	Select the speed for data transmission. The baud rate must be the same for all devices in a communications loop.
Parity	Even, Odd, None	Select None if the parity bit is not used. The parity setting must be the same for all devices in a communications loop.

7. Press **▲** to exit. Press **Yes** to save your changes.

Setting up Ethernet communications

The Ethernet Port setup screen allows you to assign the meter a unique IP address so you can use software to access the meter’s data or configure the meter remotely through the Ethernet port. Before configuring the Ethernet parameters, make sure you obtain your meter’s IP address information from your network administrator or IT department.

Ethernet communications setup menu tree

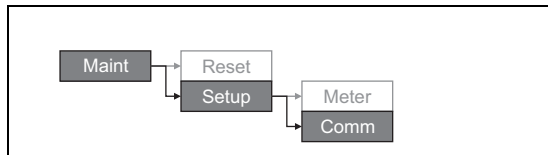

1. Navigate to **Maint > Setup**.
2. Enter the setup password (default is “0000”), then press **OK**.
3. Press **Comm**.
4. Move the cursor to point to the parameter you want to modify, then press **Edit**.
5. Modify the parameter as required, then press **OK**.
6. Move the cursor to point to the next parameter you want to modify, press **Edit**, make your changes, then press **OK**.

Ethernet port settings

Parameter	Values	Description
IP Address	Contact your local network administrator for parameter values.	The internet protocol address of your device.
Subnet		The Ethernet IP subnetwork address of your network (subnet mask).
Gateway		The Ethernet IP gateway address of your network.
HTTP Server	Disabled	Controls whether your device's webserver and webpages are active or not.
Device Name	N/A	This parameter is read-only for reference purposes.
IP Method	DHCP, BOOTP, Stored, Default	<p>This controls the network protocol for your device (what the meter uses to obtain its IP address).</p> <ul style="list-style-type: none"> DHCP: Dynamic Host Configuration Protocol BOOTP: Bootstrap Protocol Stored: Use the static value programmed in the IP Address setup register Default: Use 85.16 as the first two values of the IP address, then convert the last two hexadecimal values of the MAC address to decimal and use this as the last two values of the IP address. Example: MAC address = 00:80:67:82:B8:C8 Default IP = 85.16.184.200

- Press **▲** to exit. Press **Yes** to save your changes.

HMI settings

The HMI (human-machine interface) setup screens allow you to:

- control the general appearance and behavior of the display screens,
- change the regional settings, or
- change the meter passwords.

Setting up the display

You can change the display screen's contrast or the screen backlight and timeout settings.

Display setup menu tree

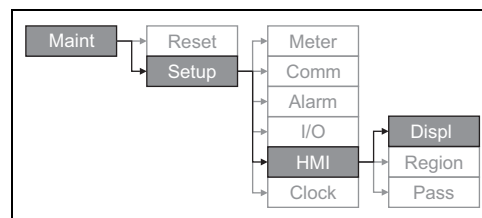

- Navigate to **Maint > Setup**.
- Enter the setup password (default is "0000"), then press **OK**.
- Navigate to **HMI > Displ**.
- Move the cursor to point to the parameter you want to modify, then press **Edit**.
- Modify the parameter as required, then press **OK**.
- Move the cursor to point to the next parameter you want to modify, press **Edit**, make your changes, then press **OK**.

Display setup parameters

Parameter	Values	Description
Contrast	1 - 9	Increase or decrease the value to increase or decrease the display contrast.
Backlight Timeout (min)	0 - 60	Set how long (in minutes) before the backlight turns off after a period of inactivity. Setting this to "0" disables the backlight timeout feature (i.e., backlight is always on).
Screen Timeout (min)	0 - 60	Set how long (in minutes) before the screen turns off after a period of inactivity. Setting this to "0" disables the screen timeout feature (i.e., display is always on).

- Press **▲** to exit. Press **Yes** to save your changes.

Setting up regional settings

You can change the regional settings to localize the meter screens and display data in a different language, using local standards and conventions.

NOTE: In order to display a different language other than those listed in the **Language** setup parameter, you need to download the appropriate language file to the meter using the appropriate firmware upgrade tool such as DLF3000. See "Downloading Firmware" on page 104.

Regional settings menu tree

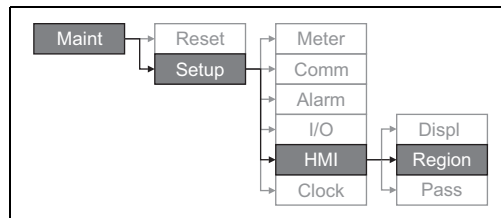

- Navigate to **Maint > Setup**.
- Enter the setup password (default is "0000"), then press **OK**.
- Navigate to **HMI > Region**.
- Move the cursor to point to the parameter you want to modify, then click **Edit**.
- Modify the parameter as required, then press **OK**.
- Move the cursor to point to the next parameter you want to modify, press **Edit**, make your changes, then press **OK**.

Regional settings setup parameters

Parameter	Values	Description
Language	English US, French, Spanish, German, Italian, Portuguese, Chinese, Russian	Select the language you want the meter to display.
Date Format	MM/DD/YY, YY/MM/DD, DD/MM/YY	Set how you want the date to be displayed, e.g., month/day/year.
Time Format	24Hr, AM/PM	Set how you want the time to be displayed, e.g., 17:00:00 or 5:00:00 PM.
HMI Mode	IEC, IEEE	Select the standards convention used to display menu names or meter data.

- Press **▲** to exit. Press **Yes** to save your changes.

Setting up the screen passwords

This can only be configured through the front panel. The factory-default setting for all passwords is "0000". Changing the default password for screens that are password-

protected prevents unauthorized personnel from accessing certain screens such as the diagnostics and reset screens.

NOTICE

LOST DATA

Record your meter's screen password information in a secure location.

Failure to follow these instructions can result in data loss.

If you lose your password, you must return the meter for factory reconfiguration, which resets your device to its factory defaults and destroys all logged data.

Password setup menu tree

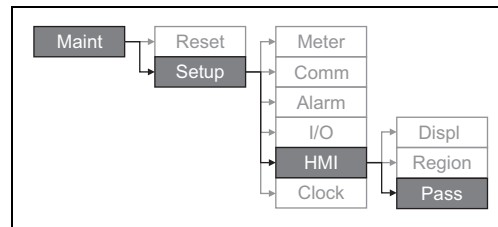

1. Navigate to **Maint > Setup**.
2. Enter the setup password (default is "0000"), then press **OK**.
3. Navigate to **HMI > Pass**.
4. Move the cursor to point to the parameter you want to modify, then press **Edit**.
5. Modify the parameter as required, then press **OK**.
6. Move the cursor to point to the next parameter you want to modify, press **Edit**, make your changes, then press **OK**.

Password setup parameters

Parameter	Values	Description
Setup	0000 - 9999	Sets the password for accessing the meter setup screens (Maint > Setup).
Energy Resets	0000 - 9999	Sets the password for resetting the meter's accumulated energy values.
Demand Resets	0000 - 9999	Sets the password for resetting the meter's recorded peak demand values.
Min/Max Resets	0000 - 9999	Sets the password for resetting the meter's recorded minimum and maximum values.
Diagnostics	0000 - 9999	Sets the password for accessing the meter's diagnostics screens.

7. Press **▲** to exit. Press **Yes** to save your changes.

Lost password

If you lose your password, contact technical support for instructions on how to return your meter for factory reconfiguration.

- Global-PMC-Tech-support@schneider-electric.com
- (00) + 1 (250) 544-3010

NOTE: Be sure to include your meter's serial number in your e-mail or have it readily available when calling technical support.

Setting the clock

The Clock setup screens allow you to set the meter’s date and time.

Clock setup menu tree

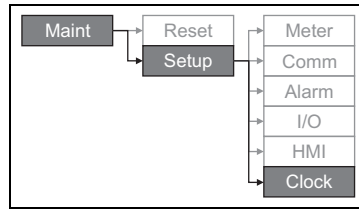

1. Navigate to **Maint > Setup**.
2. Enter the setup password (default is “0000”), then press **OK**.
3. Navigate to **Clock**.
4. Move the cursor to point to the parameter you want to modify, then press **Edit**.
5. Modify the parameter as required, then press **OK**.
6. Move the cursor to point to the next parameter you want to modify, press **Edit**, make your changes, then press **OK**.

Clock setup parameters

Parameter	Format	Description
Date	MM/DD/YY	Set the current date using the format displayed on screen, where MM = month, DD = day and YY = year.
Time	HH:MM:SS (24 hour format),	Use the 24-hour format to set the current time (GMT or local) in hours (HH), minutes (MM) and seconds (SS).
Meter Time	GMT, Local	Select GMT if you set the current time to Greenwich Mean Time zone. Otherwise, select Local.
GMT Offset (h)	-	Set the GMT Offset between ± 00.0 and ± 12.0 hrs.

7. Press **▲** to exit. Press **Yes** to save your changes.

Related topics

- See “Setting up regional settings” on page 39 for instructions on changing the format of the displayed date and time.

Advanced setup

The advanced setup screens let you change the meter name, set up a timer for monitoring load current, and specify the minimum demand current for total demand distortion calculations.

- Load Timer Setpt: specifies the minimum current at the load before the timer starts.
- Pk I dmd for TDD: specifies the minimum current demand value to consider for total demand distortion calculations.

Advanced setup menu tree

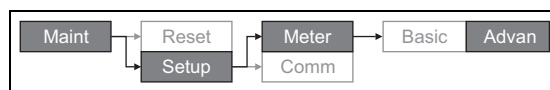

1. Navigate to **Maint > Setup**.
2. Enter the setup password (default is “0000”), then press **OK**.

3. Navigate to **Meter > Advan.**
4. Move the cursor to point to the parameter you want to modify, then press **Edit**.
5. Modify the parameter as required, then press **OK**.
6. Move the cursor to point to the next parameter you want to modify, press **Edit**, make your changes, then press **OK**.

Advanced setup parameters

Parameter	Values	Description
Label	-----	This label identifies the device, e.g., "Power Meter". You cannot use the front panel to edit this parameter. Use ION Setup to change the device label.
Load Timer Setpt (A)	0 - 99999	Specifies the minimum average current at the load before the timer starts. The meter begins counting the operating time whenever the readings are equal to or above this average current threshold.
Pk I dmd for TDD (A)	0 - 99999	Specifies the minimum peak current demand at the load for inclusion in total demand distortion (TDD) calculations. If the load current is below the minimum peak current demand threshold, the meter does not use the readings to calculate TDD. Set this to "0" (zero) if you want the power meter to use the metered peak current demand for this calculation.

7. Press **Yes** to save your changes.

Related topics

- See "Total Harmonic Distortion and Total Demand Distortion" on page 89 for details on how the meter calculates TDD.

Setting up the alarm / energy pulsing LED

The LED setup screen allows you to configure the alarm / energy pulsing LED for alarming or energy pulsing application.

Alarm / energy pulsing LED settings menu tree

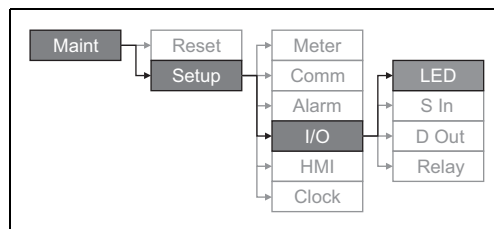

1. Navigate to **Maint > Setup**.
2. Enter the setup password (default is "0000"), then press **OK**.
3. Navigate to **I/O > LED**.
4. Press **Edit**.
5. Press **+** or **-** to modify the parameter as required, then press **OK**.

LED setup parameter

Parameter	Values	Description
Mode	Off, Alarm, Energy	Off disables the LED. Alarm sets the LED for alarm notification. Energy sets the LED for energy pulsing.

6. Press **▲** to exit. Press **Yes** to save your changes.

Related topics

- See “Setting up the alarm / energy pulsing LED” on page 42 for details on setting up the LED for alarms.

Input / output setup

The meter’s input/output (I/O) ports extend the capabilities of the meter. The I/O ports can be configured using the front panel or ION Setup.

Related topics

- See “Input / Output” on page 49 for a comprehensive description and setup instructions using the front panel.
- See “Technical Specifications” on page 15 for electrical characteristics and limits of meter’s I/O ports.

Demand setup

Demand is a measure of average consumption over a fixed time interval.

Use the Demand setup screens to define power demand, current demand or input metering demand.

Demand setup menu tree

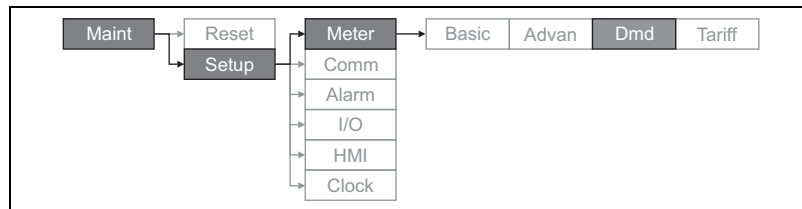

1. Navigate to **Maint > Setup**.
2. Enter the setup password (default is “0000”), then press **OK**.
3. Navigate to **Meter > Dmd**.
4. Move the cursor to select **Power Demand** or **Current Demand**.
5. Move the cursor to point to the parameter you want to modify, then press **Edit**.
6. Modify the parameter as required, then press **OK**.
7. Move the cursor to point to the next parameter you want to modify, press **Edit**, make your changes, then press **OK**.

Power or current demand setup parameters

Parameter	Values	Description
Method	Timed Sliding Block Timed Block Timed Rolling Block Cmd Sync Block Cmd Sync Roll Block Clock Sync Block Clock Sync Roll Block Input Sync Block Input Sync Roll Block Thermal	See “Demand” on page 79 for details.
Interval (min)	0 - 60	Set the demand interval, in minutes.

Power or current demand setup parameters *(continued)*

Parameter	Values	Description
Subinterval (min)	0 - 60	Applies only to rolling block methods. Define how many subintervals the demand interval should be equally divided into.
Select Dig Output	None, Digital Output D1, Digital Output D2	Select which digital output the end of demand interval pulse should be sent to.
Select S Input	None, Status Input S1, Status Input S2	Applies only to input block methods. Select which status input is used to monitor input metering demand.
Clock Sync Time	0 - 2359	Applies only to clock sync methods (these synchronize the demand interval to the meter's internal clock). Define what time of day you want to synchronize the demand

- Press **Yes** to save your changes.

Multi-tariff setup

The meter's multi-tariff feature allows you to use up to 4 different tariff "containers" to store accumulated energy data. The Tariff setup screens allow you to configure how and when to apply the different tariffs.

Related topics

- See "Configuring tariffs using the front panel" on page 87 for a comprehensive description and setup instructions using the front panel.

Alarms setup

An alarm is the meter's means of notifying you when an alarm condition is detected, such as an error or event that falls outside of normal operating conditions.

Related topics

- See "Alarms" on page 63 for a comprehensive description and detailed setup instructions.

Remote Meter Setup

You can use ION Setup to remotely access the meter.

For more information on the ION setup configuration, please refer to *ION Setup 3.0 Device configuration guide*.

Chapter 5—Viewing Meter Data

You can view meter data from the meter’s front panel display, a web browser, or through software.

Viewing meter data from the front panel

The Summary screen displays real-time values for average voltage and current (Vavg, Iavg), total power (Ptot) and energy consumption (E Del).

Summary screen

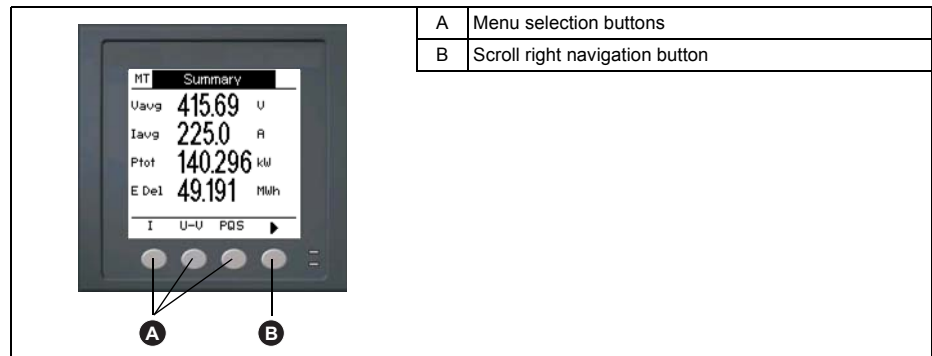

Displaying data screens

To display data screens, press the button below the appropriate menu. To see more menu items, press the ► navigation button.

Related topics

- See “Front panel display and meter setup” on page 31 for information on front panel menu navigation.

Meter data display screens

The screen menu items are listed below. The titles listed are for the HMI mode in IEEE, with the corresponding titles in IEC mode in square brackets [].

Related topics

- See “Setting up regional settings” on page 39 for details on changing the HMI mode.

Amps [I]

Phase	Instantaneous current measurements for each phase and neutral.
Dmd	Summary of peak current demand values at the last demand interval for each phase and neutral.
IAvg, Ia [I1], Ib [I2], Ic [I3], In, Ig	Real-time demand (Pres), peak demand (Peak) and predicted demand (Pred) for the present interval. Average demand for the previous interval (Last).
Pk DT	Date and timestamp for the peak demand readings.
Ig	Average (Iavg), neutral (In) and residual/ground (Ig) current

Related topics

- See “Current demand” on page 81.

Volts [U-V]

V L-L [U]	Line-to-line voltage for each phase.
V L-N [V]	Line-to-neutral voltage for each phase.

Harm

V L-L [U] Fund, 3-11, 13-21, 23-31	Line-to-line voltage harmonics data: Numeric magnitude and angle for the fundamental harmonic, and graphical representation of harmonics for the 3rd to 11th, 13th to 21st, and 23rd to 31st odd harmonics for each line-to-line phase voltage.
V L-N [V] Fund, 3-11, 13-21, 23-31	Line-to-neutral voltage harmonics data: Numeric magnitude and angle for the fundamental harmonic, and graphical representation of harmonics for the 3rd to 11th, 13th to 21st, and 23rd to 31st odd harmonics for each line-to-neutral phase voltage.
Amps [I] Fund, 3-11, 13-21, 23-31	Current harmonics data: Numeric magnitude and angle for the fundamental harmonics, and graphical representation of harmonics for the 3rd to 11th, 13th to 21st, and 23rd to 31st odd harmonics for each phase current.
TDD	Total demand distortion for each phase voltage.

Related topics

- See “Power quality” on page 89.

Power [PQS]

Power [PQS]	Summary of real-time power consumption values for total active power [Ptot] in kW, total reactive power [Qtot] in kVAR, and total apparent power [Stot] in kVA.
Phase Active [P], Reac [Q], Appr [S]	Per phase (A [P1], B [P2], C [P3]) and total (Total [Ptot]) power values for active power in kW, reactive power in kVAR and apparent power in kVA.
Dmd	Summary of peak power demand values in the previous (Last) demand interval period for active power in kW, reactive power in kVAR and apparent power in kVA.
Wd [Pd], VARd [Qd], VAd [Sd]	Total and per phase (A [1], B [2], C [3]) peak power demand values in the previous (Last) demand interval for active power demand (Wd [P]), reactive power demand (VARd [Q]) and apparent power demand (VAd [S]).
Tot, A [P1], B [P2], C [P3]	Each of these sub-screens (total and per phase demand) display power demand values for the current (Pres) demand interval, predicted (Pred) demand based on the current power consumption rate, demand for the previous (Last) demand interval period, and the recorded peak (Peak) power demand value.
Pk DT	Date and timestamp for the peak (Peak) power demand value.

Related topics

- See “Demand” on page 79.

Energy [E]

Wh	Delivered (Del), received (Rec), delivered minus received (D+R) and delivered minus received (D-R) accumulated values for real energy (Wh), apparent energy (VAh) and reactive energy (VARh).
VAh	
VARh	
Tariff T1, T2, T3, T4	Displays the available tariffs (T1 through T4).
Del	Real (Wh), reactive (VARh) and apparent (VAh) energy delivered values for the selected tariff.
Rec	Real (Wh), reactive (VARh) and apparent (VAh) energy received values for the selected tariff.

Related topics

- See “Multi-tariff feature overview” on page 83.

PF

True	Per phase and total true power factor values and sign.
Disp	Per phase and total displacement power factor values and sign.

Hz [F]

Frequency (Freq), average voltage and current (Vavg, Iavg) and power factor (PF) values.
--

THD

THD	THD (ratio of harmonic content to the fundamental) for current, line-to-line voltage, and line-to-neutral voltage.
Amps [I], V L-L [U], V L-N [V]	
thd	thd (ratio of harmonic content to the rms value of total harmonic content) for current, line-to-line voltage, and line-to-neutral voltage.
Amps [I], V L-L [U], V L-N [V]	

Related topics

- See “Power quality” on page 89.

Unbal

Percent unbalance readings for line-to-line voltage (V L-L [U]), line-to-neutral voltage (V L-N [V]) and current (Amps [I]).
--

MnMx

MnMx	Summary of maximum values for line-to-line voltage, line-to-neutral voltage, phase current and total power.
Amps [I]	Minimum and maximum values for phase current.
Volts	Minimum and maximum values for line-to-line voltage and line-to-neutral voltage.
V L-L, V L-N	
Power	Minimum and maximum values for active, reactive, and apparent power.
Active, Reac, Apr	
PF	Minimum and maximum values for true and displacement PF and PF sign.
True, Disp	
Hz	Minimum and maximum values for frequency.
THD	Minimum and maximum values for total harmonic distortion (THD or thd).
THD, thd	
Amps, V L-L, V L-N	THD or thd minimum and maximum values for phase or neutral current, line-to-line voltage and line-to-neutral voltage.
Unbal	Minimum and maximum values for current unbalance, line-to-line voltage unbalance and line-to-neutral voltage unbalance..
Amps, V L-L, V L-N	

Alarm

Active, Hist, Count, Unack	Lists all active alarms, past alarms (Hist), the total number each standard alarm has been tripped (Count), and all unacknowledged alarms.
----------------------------	--

Related topics

- See “Alarms” on page 63.

I/O

D Out	Current status (on or off) of the selected digital output, status input or relay. Counter shows the total number of times an off-to-on change of state is detected. Timer shows the total time (in seconds) that a digital output, status input or relay is in the on state.
S In	
Relay	

Related topics

- See “Input / Output” on page 49.

Timer

Load	Real-time counter that keeps track of the total number of days, hours, minutes and seconds an active load is connected to the meter inputs.
Oper	Real-time counter for the total number of days, hours, minutes and seconds the meter has been powered.

Maint

Reset	Screens to perform global or single resets.
Setup Meter, Comm, Alarm, I/O, HMI, Clock	Setup screens for meter configuration.
Diag Info, Meter, Cl Pwr, PhAng	Diagnostic screens provide meter information, status and event data for troubleshooting. The PhAng screen displays a graphical representation of the power system the meter is monitoring.

Related topics

- See “Meter resets” on page 99.
- See “Front panel display and meter setup” on page 31.
- See “Maintenance and Troubleshooting” on page 103.

Clock

Meter date and time (local or GMT).

Using ION Setup to view or modify configuration data

You can use ION Setup to view or modify the meter setup parameters.

For more information on configuration, see *ION Setup 3.0 Device configuration guide*.

Using software to view meter data

You can view meter data using energy management software such as Struxureware Power Monitoring Expert or Struxureware Power SCADA. Refer to the software documentation for details.

Chapter 6—Input / Output

This section describes the meter's I/O (input/output) features.

Based on the reference model, the meter is equipped with the following status input, digital output and relay output ports:

Status Input, Digital Output Ports and Relay Output Ports

Reference Models	Status Input Ports	Digital Output Ports	Relay Output Ports
PM5310	2 (S1+, S2+)	2 (D1+, D2+)	-
PM5320	2 (S1+, S2+)	2 (D1+, D2+)	-
PM5330	2 (S1+, S2+)	2 (D1+, D2+)	2 (Relay 1, Relay 2)
PM5331	2 (S1+, S2+)	2 (D1+, D2+)	2 (Relay 1, Relay 2)
PM5340	2 (S1+, S2+)	2 (D1+, D2+)	2 (Relay 1, Relay 2)
PM5341	2 (S1+, S2+)	2 (D1+, D2+)	2 (Relay 1, Relay 2)

NOTE: Relay = Form A relay

After you wire the meter's I/O ports, you can configure these ports so you can use the meter to perform I/O functions.

Status input applications

Status inputs are typically used for monitoring the status of external contacts or circuit breakers.

The meter's status inputs require either an external voltage source or whetting voltage (provided in the meter) to detect the status input's ON/OFF state. The meter detects an ON state if the external voltage appearing at the status input is within its operating range.

⚠ DANGER

HAZARD OF ELECTRIC SHOCK, EXPLOSION, OR ARC FLASH

- Apply appropriate personal protective equipment (PPE) and follow safe electrical work practices. See NFPA 70E in the USA or applicable local standards.
- Turn off all power supplying this device before working on it.
- Always use a properly rated voltage sensing device to confirm that all power is off.
- Do not exceed the device's ratings for maximum limits.
- Do not use this device for critical control or protection applications where human or equipment safety relies on the operation of the control circuit.

Failure to follow these instructions will result in death or serious injury.

Wiring the status inputs

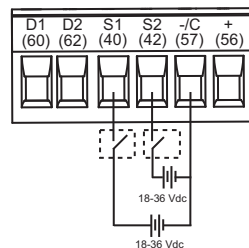

Related topics

- See “Technical Specifications” on page 15 for electrical characteristics and limits for the status inputs.

Status input setup

The status input ports (S1 and S2) can be configured using the front panel or ION Setup software.

NOTE: It is recommended you use ION Setup to configure the status inputs, as setup parameters that require text entry can only be modified using ION Setup.

Configuring status inputs using ION Setup

You can use ION Setup to configure the status inputs.

1. Start ION Setup.
2. Connect to your meter.
3. Navigate to **I/O configuration > I/O Setup**.
4. Select a status input to configure and click **Edit**. The setup screen for that status input is displayed.
5. Enter a descriptive name for the status input's **Label**.
6. Configure the other setup parameters as required.
7. Click **Send** to save your changes.

Status input setup parameters available through ION Setup

Parameter	Values	Description
Label	—	Use this field to change the default label and assign a descriptive name to this status input.
Control Mode	Normal, Demand Sync, Input Metering	This field displays how the status input functions. <ul style="list-style-type: none"> • Normal: the status input is not associated with another meter function. The meter counts and records the number of incoming pulses normally. • Demand Sync: the status input is associated with one of the input sync demand functions. The meter uses the incoming pulse to synchronize its demand period with the external source. • Input Metering: the status input is associated with one of the input metering channels. The meter counts and records the number of incoming pulses and related consumption data associated with the pulses.
Debounce	0 to 9999	Debounce is the time delay that compensates for mechanical contact bounce. Use this field to set how long (in milliseconds) the external signal must remain in a certain state to be considered a valid state change.
Associations	—	This field displays additional information if the status input is already associated with another meter function.

Configuring status inputs using the front panel

You can use the front panel to configure the status inputs.

Status input setup menu tree

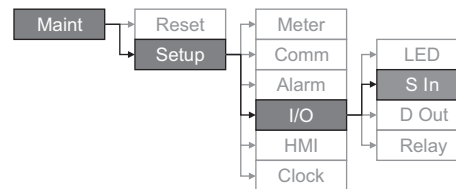

1. Navigate to **Maint > Setup**.
2. Enter the setup password (default is “0”), then press **OK**.
3. Navigate to **I/O > S In**.
4. Move the cursor to point to the status input you want to set up, then press **Edit**.
5. Move the cursor to point to the parameter you want to modify, then press **Edit**.

NOTE: If **Edit** is not displayed, it means the parameter is either read-only or can only be modified through software.

6. Modify the parameter as required, then press **OK**.

Status input setup parameters available through the front panel

Parameter	Values	Description
Label	—	This can be modified only through software. Use this field to assign names to the status inputs (S1 and S2).
Debounce Time (ms)	0 to 1000	Debounce is the time delay that compensates for mechanical contact bounce. Use this field to set how long (in milliseconds) the external signal must remain in a certain state to be considered a valid state change.
Control Mode	Normal	This field displays how the status input functions. Normal: the status input is not associated with another meter function. The meter counts and records the number of incoming pulses normally.

7. Move the cursor to point to the next parameter you want to modify, press **Edit**, make your changes, then press **OK**.
8. Press **▲** to exit. Press **Yes** to save your changes.

Related topics

See “Technical Specifications” on page 15 for electrical characteristics and limits for the status inputs.

Digital output applications

Digital outputs are typically used in switching applications, for example, to provide on/off control signals for switching capacitor banks, generators, and other external devices and equipment. They can also be used in demand synchronization applications, where the meter provides pulse signals to the input of another meter to control its demand period.

The digital output can also be used in energy pulsing applications, where a receiving device determines energy usage by counting the kWh pulses coming from the meter's digital output port.

⚠ DANGER

HAZARD OF ELECTRIC SHOCK, EXPLOSION, OR ARC FLASH

- Apply appropriate personal protective equipment (PPE) and follow safe electrical work practices. See NFPA 70E in the USA or applicable local standards.
- Turn off all power supplying this device before working on it.
- Always use a properly rated voltage sensing device to confirm that all power is off.
- Do not exceed the device's ratings for maximum limits.
- Do not use this device for critical control or protection applications where human or equipment safety relies on the operation of the control circuit.

Failure to follow these instructions will result in death or serious injury.

NOTE: Be aware that an unexpected change of state of the digital outputs may result when the supply power to the meter is interrupted or after a meter firmware upgrade.

Digital output application example

You can connect your meter's digital outputs to other meters to send a demand sync pulse. In the following example, the first meter (Meter 1) controls and sets the demand period of the other meters (Meter 2, Meter 3, Meter 4) through the output pulse occurring at the end of the first meter's demand interval.

Digital output wiring example

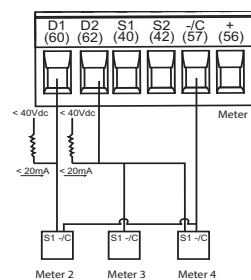

Related topics

- See "Technical Specifications" on page 15 for electrical characteristics and limits for the digital outputs.

Digital output setup

The digital output ports (D1 and D2) can be configured using the front panel or ION Setup.

NOTE: It is recommended you use ION Setup to configure the digital outputs, as setup parameters that require text entry can only be modified using software.

Configuring digital outputs using ION Setup

You can use ION Setup to configure the digital outputs (D1 and D2).

1. Start ION Setup.
2. Connect to your meter
3. Navigate to **I/O configuration > I/O Setup**.
4. Select a digital output to configure and click **Edit**. The setup screen for that digital output is displayed.
5. Enter a descriptive name for the digital output's **Label**.
6. Configure the other setup parameters as required.
7. Click **Send** to save your changes.

Digital output setup parameters available through ION Setup

Parameter	Values	Description
Label	—	Use this field to change the default label and assign a descriptive name to this digital output.
Control Mode	External, Demand Sync, Alarm	<p>This field displays how the digital output functions.</p> <ul style="list-style-type: none"> • External: the digital output is controlled remotely either through software or by a PLC using commands sent through communications. • Demand Sync: the digital output is associated with one of the demand systems. The meter sends a pulse to the digital output port at the end of every demand interval. • Alarm: the digital output is associated with the alarm system. The meter sends a pulse to the digital output port when the alarm is triggered.
Behavior Mode	Normal, Timed, Coil Hold	<ul style="list-style-type: none"> • Normal: this mode applies when control mode is set to External or Alarm. The digital output remains in the ON state until an OFF command is sent by the computer or PLC. • Timed: the digital output remains ON for the period defined by the On Time setup register. • Coil Hold: this mode applies when control mode is set to External or Alarm. For a unary alarm that is associated with a digital output, you must set Behavior Mode to Coil Hold. The output turns on when the "energize" command is received and turns off when the "coil hold release" command is received. In the event of a control power loss, the output remembers and returns to the state it was in when control power was lost.
On Time (s)	0 to 9999	This setting defines the pulse width (ON time) in seconds.
Select Dmd System	Power, Current	Applies when Control Mode is set to Demand Sync. Select the demand system to monitor.

Digital output setup parameters available through ION Setup *(continued)*

Parameter	Values	Description
Select Alarms	1. Over Current, Ph; 2. Under Current, Ph; 3. Over Current, N; 4. Over Current Gnd; 5. Over Voltage, L-L; 6. Under Voltage, L-L; 7. Over Voltage, L-N; 8. Under Voltage L-N; 9. Over kW; 10. Over kVAR; 11. Over kVA; 12. Lead PF, True; 13. Lag PF, True; 14. Lead PF, Disp; 15. Lag PF, Disp; 16. Over kW Dmd, Pres; 17. Over kW Dmd, Last; 18. Over kW Dmd, Pred; 19. Over kVAR Dmd,Pres; 20. Over kVAR Dmd,Last; 21. Over kVAR Dmd,Pred; 22. Over kVA Dmd, Pres; 23. Over kVA Dmd, Last; 24. Over kVA Dmd, Pred; 25. Over Frequency; 26. Under Frequency; 27. Over Voltage Unbal; 28. Over Voltage THD; 29. Phase Loss; 30. Meter Powerup; 31. Meter Reset; 32. Meter Diagnostic; 33. Phase Reversal; 34. Digital Alarm S1; 35. Digital Alarm S2;	Applies when Control Mode is set to Alarm. Select one or more alarms to monitor.
Associations	—	This field displays additional information if the digital output is already associated with another meter function.

Configuring digital outputs using the front panel

You can use the front panel to configure the digital outputs.

Digital output setup menu tree

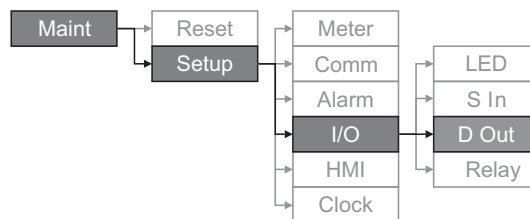

1. Navigate to **Maint > Setup**.
2. Enter the setup password (default is "0000"), then press **OK**.
3. Navigate to **I/O > D Out**.

4. Move the cursor to point to the digital output you want to set up, then press **Edit**.
5. Move the cursor to point to the parameter you want to modify, then press **Edit**.

NOTE: If **Edit** is not displayed, it means the parameter is either read-only or can only be modified through software.

6. Modify the parameter as required, then press **OK**.
7. Move the cursor to point to the next parameter you want to modify, press **Edit**, make your changes, then press **OK**.
8. Press **▲** to exit. Press **Yes** to save your changes.

Digital output setup parameters available through the front panel

Parameter	Values	Description
Label	-----	This can be modified only through software. Use this field to change the default label and assign a descriptive name to this digital output.
Control Mode	External, Demand Sync, Alarm	This displays how the digital output functions. <ul style="list-style-type: none"> • External: the digital output is controlled remotely either through software or by a PLC using commands sent through communications. • Demand Sync: the digital output is associated with one of the demand systems. The meter sends a pulse to the digital output port at the end of every demand interval. • Alarm: the digital output is associated with the alarm system. The meter sends a pulse to the digital output port when the alarm is triggered.
Behavior Mode	Normal, Timed, Coil Hold	<ul style="list-style-type: none"> • Normal: this applies when control mode is set to External or Alarm. The digital output remains in the ON state until an OFF command is sent by the computer or PLC. • Timed: the digital output remains ON for the period defined by the On Time setup register. • Coil Hold: this applies when control mode is set to External or Alarm. For a unary alarm that is associated with a digital output, you must set Behavior Mode to Coil Hold. The output turns on when the "energize" command is received and turns off when the "coil hold release" command is received. In the event of a control power loss, the output remembers and returns to the state it was in when control power was lost.
On Time (s)	0 to 9999	This defines the pulse width (ON time) in seconds.

Digital output setup parameters available through the front panel *(continued)*

Parameter	Values	Description
Select Dmd System	Power, Current	Applies when Control Mode is set to Demand Sync. Select the demand system to monitor.
Select Alarms	<ol style="list-style-type: none"> 1. Over Current, Ph; 2. Under Current, Ph; 3. Over Current, N; 4. Over Current Gnd; 5. Over Voltage, L-L; 6. Under Voltage, L-L; 7. Over Voltage, L-N; 8. Under Voltage L-N; 9. Over kW; 10. Over kVAR; 11. Over kVA; 12. Lead PF, True; 13. Lag PF, True; 14. Lead PF, Disp; 15. Lag PF, Disp; 16. Over kW Dmd, Pres; 17. Over kW Dmd, Last; 18. Over kW Dmd, Pred; 19. Over kVAR Dmd, Pres; 20. Over kVAR Dmd, Last; 21. Over kVAR Dmd, Pred; 22. Over kVA Dmd, Pres; 23. Over kVA Dmd, Last; 24. Over kVA Dmd, Pred; 25. Over Frequency; 26. Under Frequency; 27. Over Voltage Unbal; 28. Over Voltage THD; 29. Phase Loss; 30. Meter Powerup; 31. Meter Reset; 32. Meter Diagnostic; 33. Phase Reversal; 34. Digital Alarm S1; 35. Digital Alarm S2; 	Applies when Control Mode is set to Alarm. Select one or more alarms to monitor.

Relay output applications

Relay outputs are typically used in switching applications, for example, to provide on/off control signals for switching capacitor banks, generators, and other external devices and equipment.

⚠ DANGER

HAZARD OF ELECTRIC SHOCK, EXPLOSION, OR ARC FLASH

- Apply appropriate personal protective equipment (PPE) and follow safe electrical work practices. See NFPA 70E in the USA or applicable local standards.
- Turn off all power supplying this device before working on it.
- Always use a properly rated voltage sensing device to confirm that all power is off.
- Do not exceed the device's ratings for maximum limits.
- Do not use this device for critical control or protection applications where human or equipment safety relies on the operation of the control circuit.

Failure to follow these instructions will result in death or serious injury.

NOTE: Be aware that an unexpected change of state of the relay outputs may result when the supply power to the meter is interrupted or after a meter firmware upgrade.

Relay output setup

The relay output ports (Relay 1 and Relay 2) can be configured using the front panel or ION Setup.

NOTE: It is recommended you use ION Setup to configure the relay outputs, as setup parameters that require text entry can only be modified using software.

Configuring relay outputs using ION Setup

You can use ION Setup to configure the relay outputs (Relay 1 and Relay 2).

1. Start ION Setup.
2. Connect to your meter
3. Navigate to **I/O configuration > I/O Setup**.
4. Select a relay output to configure and click **Edit**. The setup screen for that relay output is displayed.
5. Enter a descriptive name for the relay output's **Label**.
6. Configure the other setup parameters as required.
7. Click **Send** to save your changes.

Relay output setup parameters available through ION Setup

Parameter	Values	Description
Label	—	Use this field to change the default label and assign a descriptive name to this relay output.
Control Mode	External, Alarm	This field displays how the relay output functions. <ul style="list-style-type: none"> • External: the relay output is controlled remotely either through software or by a PLC using commands sent through communications. • Alarm: the relay output is associated with the alarm system. The meter sends a pulse to the relay output port when the alarm is triggered.

Relay output setup parameters available through ION Setup (continued)

Parameter	Values	Description
Behavior Mode	Normal, Timed, Coil Hold	<ul style="list-style-type: none"> • Normal: this mode applies when control mode is set to External or Alarm. The relay output remains in the ON state until an OFF command is sent by the computer or PLC. • Timed: the relay output remains ON for the period defined by the On Time setup register. • Coil Hold: this mode applies when control mode is set to External or Alarm. For a unary alarm that is associated with a relay output, you must set Behavior Mode to Coil Hold. The output turns on when the "energize" command is received and turns off when the "coil hold release" command is received. In the event of a control power loss, the output remembers and returns to the state it was in when control power was lost.
On Time (s)	0 to 9999	This setting defines the pulse width (ON time) in seconds.
Select Alarms	<ol style="list-style-type: none"> 1. Over Current, Ph; 2. Under Current, Ph; 3. Over Current, N; 4. Over Current, Gnd; 5. Over Voltage, L-L; 6. Under Voltage, L-L; 7. Over Voltage, L-N; 8. Under Voltage L-N; 9. Over kW; 10. Over kVAR; 11. Over kVA; 12. Lead PF, True; 13. Lag PF, True; 14. Lead PF, Disp; 15. Lag PF, Disp; 16. Over kW Dmd, Pres; 17. Over kW Dmd, Last; 18. Over kW Dmd, Pred; 19. Over kVAR Dmd,Pres; 20. Over kVAR Dmd,Last; 21. Over kVAR Dmd,Pred; 22. Over kVA Dmd, Pres; 23. Over kVA Dmd, Last; 24. Over kVA Dmd, Pred; 25. Over Frequency; 26. Under Frequency; 27. Over Voltage Unbal; 28. Over Voltage THD; 29. Phase Loss; 30. Meter Powerup; 31. Meter Reset; 32. Meter Diagnostic; 33. Phase Reversal; 34. Digital Alarm S1; 35. Digital Alarm S2; 	Applies when Control Mode is set to Alarm. Select one or more alarms to monitor.
Associations	—	This field displays additional information if the relay output is already associated with another meter function.

Configuring relay outputs using the front panel

You can use the front panel to configure the relay outputs.

Relay output setup menu tree

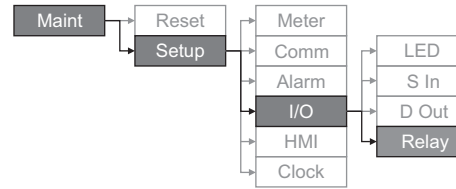

1. Navigate to **Maint > Setup**.
2. Enter the setup password (default is "0"), then press **OK**.
3. Navigate to **I/O > Relay**.
4. Move the cursor to point to the relay output you want to set up, then press **Edit**.
5. Move the cursor to point to the parameter you want to modify, then press **Edit**.

NOTE: If **Edit** is not displayed, it means the parameter is either read-only or can only be modified through software.

6. Modify the parameter as required, then press **OK**.
7. Move the cursor to point to the next parameter you want to modify, press **Edit**, make your changes, then press **OK**.
8. Press **▲** to exit. Press **Yes** to save your changes.

Relay output setup parameters available through the front panel

Parameter	Values	Description
Label	----	This can be modified only through software. Use this field to change the default label and assign a descriptive name to this relay output.
Control Mode	External, Alarm	This displays how the relay output functions. <ul style="list-style-type: none"> • External: the relay output is controlled remotely either through software or by a PLC using commands sent through communications. • Alarm: the relay output is associated with the alarm system. The meter sends a pulse to the relay output port when the alarm is triggered.
Behavior Mode	Normal, Timed, Coil Hold	<ul style="list-style-type: none"> • Normal: this applies when control mode is set to External or Alarm. The relay output remains in the ON state until an OFF command is sent by the computer or PLC. • Timed: the relay output remains ON for the period defined by the On Time setup register. • Coil Hold: this applies when control mode is set to External or Alarm. For a unary alarm that is associated with a relay output, you must set Behavior Mode to Coil Hold. The output turns on when the "energize" command is received and turns off when the "coil hold release" command is received. In the event of a control power loss, the output remembers and returns to the state it was in when control power was lost.

Relay output setup parameters available through the front panel *(continued)*

Parameter	Values	Description
On Time (s)	0 to 65535	This defines the pulse width (ON time) in seconds.
Select Alarms	1. Over Current, Ph; 2. Under Current, Ph; 3. Over Current, N; 4. Over Current, Gnd; 5. Over Voltage, L-L; 6. Under Voltage, L-L; 7. Over Voltage, L-N; 8. Under Voltage L-N; 9. Over kW; 10. Over kVAR; 11. Over kVA; 12. Lead PF, True; 13. Lag PF, True; 14. Lead PF, Disp; 15. Lag PF, Disp; 16. Over kW Dmd, Pres; 17. Over kW Dmd, Last; 18. Over kW Dmd, Pred; 19. Over kVAR Dmd,Pres; 20. Over kVAR Dmd,Last; 21. Over kVAR Dmd,Pred; 22. Over kVA Dmd, Pres; 23. Over kVA Dmd, Last; 24. Over kVA Dmd, Pred; 25. Over Frequency; 26. Under Frequency; 27. Over Voltage Unbal; 28. Over Voltage THD; 29. Phase Loss; 30. Meter Powerup; 31. Meter Reset; 32. Meter Diagnostic; 33. Phase Reversal; 34. Digital Alarm S1; 35. Digital Alarm S2;	Applies when Control Mode is set to Alarm. Select one or more alarms to monitor.

Related topics

- See “Demand setup” on page 43 for details on configuring a digital output to send demand sync pulses to another connected device.

Alarm / energy pulsing LED setup

The meter’s LED can be configured for alarm indication or energy pulsing.

When set to detect alarms, the LED blinks to indicate an alarm condition. See “Alarm Priorities” on page 66 for a description of the LED behavior based on different alarms.

When the LED is set to energy pulsing, the meter sends a readable pulse or signal based on the measured energy. This pulse can be used for accuracy verification or as an input to another energy monitoring system. The meter uses the pulse constant setting in pulses per k_h to determine the frequency and number of pulses sent to the LED (where k_h = kWh, kVARh or kVAh depending on the energy parameter selected).

The LED setup screen allows you to configure the alarm / energy pulsing LED for alarming or energy pulsing applications.

Configuring the LED or digital output for energy pulsing using ION Setup

You can use the ION Setup to configure your meter’s LED or digital output for energy pulsing.

1. Start ION Setup.
2. Connect to your meter
3. Navigate to **I/O configuration > Energy Pulsing**.
4. Select the LED or a digital output to configure and click **Edit**. The setup screen is displayed.
5. Enter a descriptive name for the digital output’s **Label**.
6. Configure the other setup parameters as required.
7. Click **Send** to save your changes.

Alarm / energy pulsing LED setup parameters available through ION Setup

Parameter	Values	Description
Mode	Off, Alarm, Energy	Off disables the LED. Alarm sets the LED for alarm notification. Energy sets the LED for energy pulsing.
Pulse Wt. (p/k_h)	1 to 9999999	When configured for energy pulsing, this defines how many pulses are sent to the LED for every 1 kWh, 1 kVARh or 1kVAh of accumulated energy.
Channel	Active Energy Delivered	Select which accumulated energy channel to monitor and use for energy pulsing.
	Active Energy Received	
	Active Energy Del+Rec	
	Reactive Energy Delivered	
	Reactive Energy Received	
	Reactive Energy Del+Rec	
	Apparent Energy Delivered	
	Apparent Energy Received	
	Apparent Energy Del+Rec	

Related topics

- See “Alarm Priorities” on page 66 for a detailed description on the alarm / energy pulsing LED’s behavior when it is configured for alarm notification.

Configuring the alarm / energy pulsing LED using the front panel

You can use the front panel display to configure your meter’s LED for alarming or energy pulsing application.

Alarm / energy pulsing LED settings menu tree

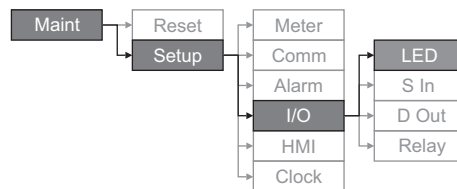

1. Navigate to **Maint > Setup**.
2. Enter the setup password (default is “0”), then press **OK**.
3. Navigate to **I/O > LED**.

4. Move the cursor to point to the parameter you want to modify, then press **Edit**.
Alarm / energy pulsing LED parameters available through the front panel

Parameter	Values	Description
Mode	Off, Alarm, Energy	Disabled turns off the LED completely. Alarm sets the LED for alarm notification. Energy sets the LED for energy pulsing.
Pulse Wt. (p/k_h)	1 to 9999999	When configured for energy pulsing, this setting defines how many pulses are sent to the LED for every 1 kWh, 1 kVARh or 1kVAh accumulated energy.
Parameter	Active Del	Select which accumulated energy channel to monitor and use for energy pulsing.
	Active Rec	
	Active Del + Rec	
	Reactive Del	
	Reactive Rec	
	Reactive Del + Rec	
	Apparent Del	
	Apparent Rec	
	Apparent Del + Rec	

5. Press **+** or **-** to modify the parameter as required, then press **OK**.
6. Press **▲** to exit. Press **Yes** to save your changes.

Chapter 7—Alarms

This section describes the alarm features on PM5300 series Power and Energy meters.

About Alarms

The  icon appears in the upper-right corner of the meter display when an alarm is active.

If the energy/alarm LED has been configured for alarms, the energy/alarm LED flashes when an alarm is active. See “Alarm / energy pulsing LED setup” on page 60 for more information.

The power meter maintains a counter for each alarm to help keep track of the total number of occurrences (see Figure 7–1).

Figure 7–1: Alarm Counters

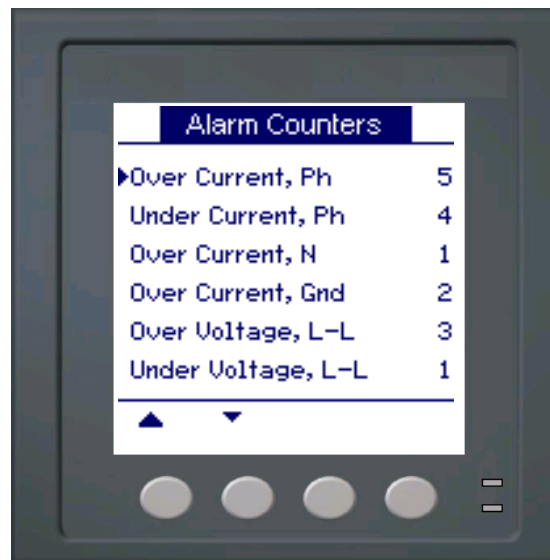

If you make changes to the basic power meter setup, all alarms are disabled to prevent undesired alarm operation. Confirm alarm configuration and enable required alarms.

NOTE: Only alarms that apply to the selected power system configuration can be enabled.

The available alarms for this power meter are described in the following sections.

1-Second Alarms

The power meter has 29 standard 1-second over/under alarms. See Table 7–1 for a complete list.

Use the display to configure 1-second alarms with the following values:

- Enable—disable (default) or enable
- Pickup Setpoint (magnitude)
- Pickup Time Delay (in seconds)

- Dropout Setpoint (magnitude)
- Dropout Time Delay (in seconds)

Table 7–1: List of Standard 1-Second Over/Under Alarms

Alarm Number	Alarm Label
01	Over Current, Phase
02	Under Current, Phase
03	Over Current, Neutral
04	Over Current, Ground
05	Over Voltage, L-L
06	Under Voltage, L-L
07	Over Voltage, L-N
08	Under Voltage L-N
09	Over kW
10	Over kVAR
11	Over kVA
12	Lead PF, True
13	Lag PF, True
14	Lead PF, Disp
15	Lag PF, Disp
16	Over kW Dmd, Pres
17	Over kW Dmd, Last
18	Over kW Dmd, Pred
19	Over kVAR Dmd, Pres
20	Over kVAR Dmd, Last
21	Over kVAR Dmd, Pred
22	Over kVA Dmd, Pres
23	Over kVA Dmd, Last
24	Over kVA Dmd, Pred
25	Over Frequency
26	Under Frequency
27	Over Voltage Unbal
28	Over Voltage THD
29	Phase Loss

Many of the 1-second alarms are three-phase alarms. Alarm setpoints are evaluated for each of the three phases individually, but the alarm is reported as a single alarm. The alarm pickup occurs when the first phase exceeds the alarm pickup magnitude for the pickup time delay. The alarm is active as long as any phase remains in an alarm state. The alarm dropout occurs when the last phase drops below the dropout magnitude for the dropout time delay. See Figure 7–2 below.

Figure 7–2: How the power meter handles setpoint-driven alarms

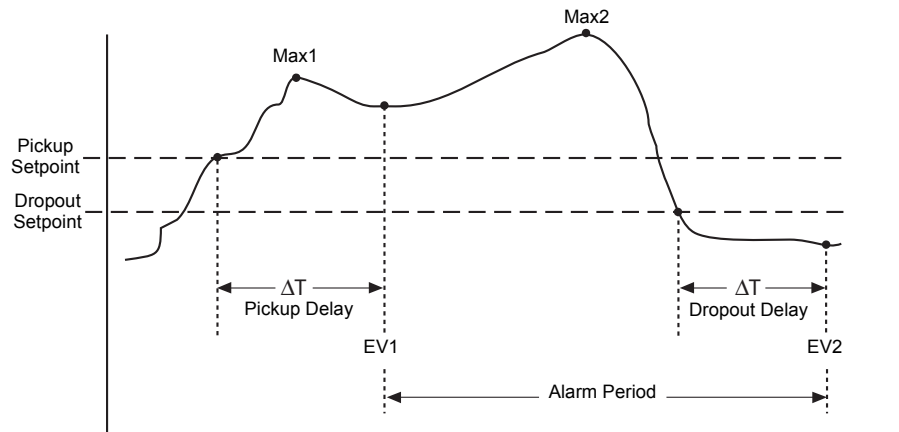

EV1—The power meter records the date and time that the pickup setpoint and time delay were satisfied, and the maximum value reached (Max1) during the pickup delay period (ΔT). Also, the power meter performs any tasks assigned to the event such as operation of a digital output.

EV2—The power meter records the date and time that the dropout setpoint and time delay were satisfied, and the maximum value reached (Max2) during the alarm period.

Digital Alarms

The power meter has two digital alarms for alarming on status input status. By default, the digital alarms are active when the associated status input is ON. The pickup and dropout time delays are configured in seconds.

Unary Alarms

The power meter has four unary alarms. These alarms help to alert you when the meter powers on after a control power loss, when the meter resets for any reason, when the meter self-diagnostic feature detects a problem, or when the meter detects a phase rotation different than expected.

Alarm Priorities

Each alarm has a priority level. Use priorities to help distinguish between events that require immediate action and those that do not require action. See “Setting up the alarm / energy pulsing LED” on page 42 for information on configuring the alarm LED for alarm mode.

- **High priority**—if a high priority alarm occurs, the display informs you in two ways: the alarm LED on the display flashes until you acknowledge the alarm, and the alarm icon blinks while the alarm is active. An alarm message is displayed while the alarm is active. See “Viewing Unacknowledged Alarms and the Alarm History Log” on page 73 for information on acknowledging alarms.
- **Medium priority**—if a medium priority alarm occurs, the alarm LED and the alarm icon blink only while the alarm is active. An alarm message is displayed while the alarm is active.
- **Low priority**—if a low priority alarm occurs, the alarm LED and the alarm icon blink only while the alarm is active. No alarm message is displayed.
- **No priority**—if an alarm is set up with no priority, no visible representation appears on the display. Alarms with no priority are not entered in the alarm Log.

If multiple alarms with different priorities are active at the same time, the display shows the alarms in the order they occurred.

When a pickup event occurs, the active alarm list appears. Press “Detail” to see more event information. See “Alarm Setup” on page 66 for more information.

Using an Alarm to Control a Relay and Digital Output

Relays can be configured as external, and alarm. Digital Outputs can be configured as external, demand sync, and alarm. See the “Setting Up Alarms” sections in this chapter and “Digital output setup” on page 52.

Alarm Setup

Evaluation of all alarms is temporarily suspended while alarm setup screens are displayed. Evaluation resumes immediately upon exit from alarm setup screens.

To set up standard alarms:

To set up standard alarms:

1. Navigate to **Maint > Setup**.
2. Enter the setup password (default is “0000”), then press **OK**.
3. Press **Alarm**.

Use the directions in the following sections to set up alarms.

Setting Up 1-Second Alarms

To set up a standard alarm:

1. Press **1-Sec**. The 1-second alarm Select screen appears.
2. Press ▼ and ▲ to scroll through the list of standard 1-second alarms.
3. Press **Edit** to select an alarm to be configured.
4. Press **Edit** to select Pickup Setpoint.
5. Press + to increment the active digit through the numerals 0-9.
6. Press ◀ to enter the selected value for the active digit and move to the next digit to the left.
7. Continue until all values are selected, then press **OK** to enter the selected number for the pickup setpoint.
8. For power factor alarms (Lead PF, True; Lag PF, True; Lead PF, Disp; and Lag PF, Disp) press ▼ to select PU Set Point Lead/Lag, then press **Edit**. For other alarms, skip to Step 11.
9. Press + and - to scroll between Lead and Lag.
10. Press **OK** to set the pickup set point lead or lag.
11. Press ▼ and follow Steps 4 to 7 for Pickup Time Delay and Dropout Setpoint.
12. For power factor alarms, press ▼ to select DO Set Point Lead/Lag and follow Steps 10 and 11. For other alarms, proceed to Step 14.
13. Press ▼ and follow Steps 4 to 7 for Dropout Time Delay.
14. Press ▼ to select Enable, then press **Edit**.
15. Press + and - to scroll between Yes and No.
16. Press **OK** to enable or disable the alarm.

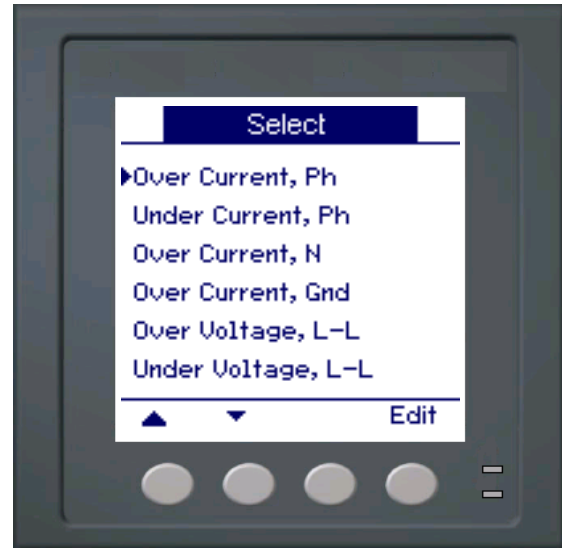

Setting Up 1-Second Alarms (continued)

17. Press ▼ to select Priority, then press **Edit**.
18. Press + and - to scroll through priority options None, High, Medium, or Low.
NOTE: See “Alarm Priorities” on page 66 for more information.
19. Press **OK** to set the priority.
20. Press ▼ to select Select Digital Output, then press **Edit**.
21. Press + and - to scroll through the list of digital outputs to associate with the alarm.
22. Press **OK** to select a digital output to be associated with the selected alarm.
23. If the selected digital output already has an association that will be lost by making the new selection, a confirmation screen appears.
 - Press **Yes** to accept the changes and return to the previous screen.
 - Press **No** to keep the existing configuration in use and return to the previous screen.
24. Press ▲ to save all alarm selections and return to the previous screen.
25. Press ▲ to save all 1-second alarm selections.

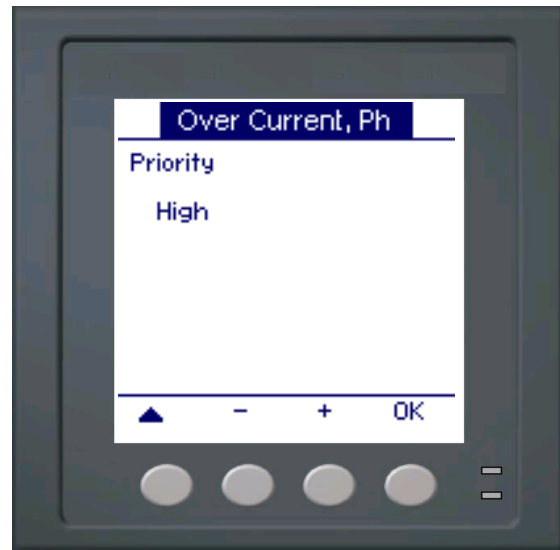

NOTE: The Over Demand alarms are applicable for systems in which the energy is delivered to the customer only.

Setting Up Unary Alarms

To set up unary alarms:

1. Press **Unary**. The unary alarm Select screen appears.
2. Press **▼** and **▲** to scroll through the list of unary alarms.
3. Press **Edit** to select an alarm to be configured.
4. Press **Edit** to select Enable.
5. Press **+** and **-** to scroll between Yes and No.
6. Press **OK** to enable or disable the alarm.
7. Press **▼** to select Priority.
8. Press **+** and **-** to scroll through priority options Low, None, High, or Medium.

NOTE: See “Alarm Priorities” on page 66 for more information.

9. Press **OK** to set the priority.
10. Press **▼** to select Select Digital Output, then press **Edit**.

NOTE: The digital output behavior mode must be Timed or Coil Hold to turn on when a unary alarm event occurs.
11. Press **+** and **-** to scroll through the list of digital outputs to associate with the alarm.
12. Press **OK** to select a digital output to be associated with the selected alarm.
13. If the selected digital output already has an association that will be lost by making the new selection, a confirmation screen appears.
 - Press **Yes** to accept the changes and return to the previous screen.
 - Press **No** to keep the existing configuration in use and return to the previous screen.
14. Press **▲** to save all alarms selections and return to the previous screen.
15. Press **▲** to save all unary alarm selections.



Setting Up Digital Alarms

To set up digital alarms:

1. Press **Dig**. The digital alarm Select screen appears.
2. Press **▼** and **▲** to scroll through the list of digital alarms.
3. Press **Edit** to select an alarm to be configured.
4. Press **Edit** to select Pickup Setpoint, then press **Edit**.
5. Press **+** and **-** to scroll between On and Off.
6. Press **OK** to enter the pickup setpoint.
7. Press **▼** to select Pickup Time Delay, then press **Edit**.

NOTE: If the selected status input mode is Demand Sync or Input Metering, a confirmation screen appears warning that if an alarm is enabled for this status input, the existing association will be broken.

8. Press **+** to increment the active digit through the numerals 0-9.

NOTE: Units for time delays are set in seconds.
9. Press **◀** to enter the selected value for the active digit and move to the next digit to the left.
10. Continue until all values are selected, then press **OK** to enter the pickup time delay.
11. Press **▼** to select Dropout Time Delay, then press **Edit**.
12. Follow Steps 8 to 11 for the dropout time delay.



Setting Up Digital Alarms (continued)

13. Press ▼ to select Enable, then press **Edit**.
14. Press + and - to scroll between Yes and No.
15. Press **OK** to enable or disable the alarm.
16. Press ▼ to select Priority, then press **Edit**.
17. Press + and - to scroll through priority options None, High, Medium, or Low.
NOTE: See “Alarm Priorities” on page 66 for more information.
18. Press **OK** to set the priority.
19. Press ▼ to select Select Digital Output, then press **Edit**.
20. Press + and - to scroll through the list of digital outputs to associate with the alarm.
21. Press **OK** to select a digital output to be associated with the selected alarm.
22. If the selected digital output already has an association that will be lost by making the new selection, a confirmation screen appears.
 - Press **Yes** to accept the changes and return to the previous screen.
 - Press **No** to keep the existing configuration in use and return to the previous screen.
23. Press ▲ to save all alarm selections and return to the previous screen.
24. Press ▲ to save all digital alarm selections.



Viewing Alarm Activity and History

There are two types of alarm entries: primary and secondary. The primary entry identifies the alarm. The secondary entries provide pickup and dropout information.

The active alarm list holds 40 entries at a time. The list works as a circular buffer, replacing old entries as new entries over 40 are entered into the alarm event queue. The information in the alarm event queue reinitializes when the power meter resets.

The alarm history log holds 40 entries. The log also works as a circular buffer, replacing old entries with new entries. This information is nonvolatile.

Viewing Active Alarms and Alarm Counters

To view active alarms or alarm counters:

1. Scroll through the menu list at the bottom of the screen until you see **Alarm**.
2. Press **Alarm**.
3. Press the button beneath **Active** or **Count**.
4. Press ▼ and ▲ to scroll through the alarm list.
5. Press ▲ to return to the previous screen.

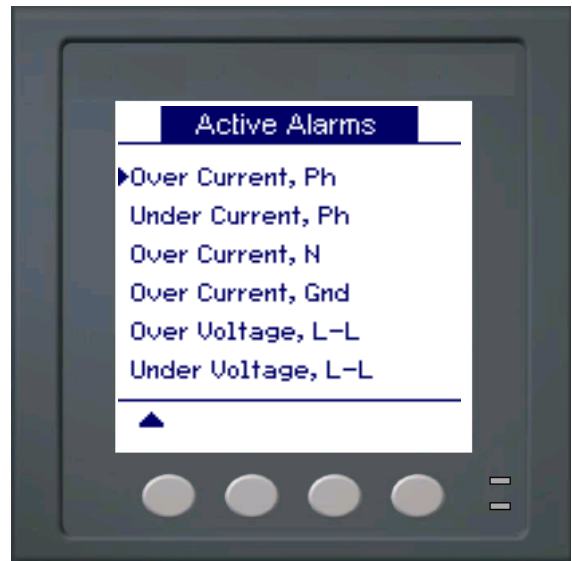

Alarm Counters	
▶ Over Current, Ph	5
Under Current, Ph	4
Over Current, N	1
Over Current, Gnd	2
Over Voltage, L-L	3
Under Voltage, L-L	1

Viewing Unacknowledged Alarms and the Alarm History Log

To view the unacknowledged alarms or the alarm history log:

1. Scroll through the menu list at the bottom of the screen until you see **Alarm**.
2. Press **Alarm**.
3. Press the button beneath **Unack** or **Hist**.
4. Press ▼ and ▲ to scroll through the list of primary alarm events.
5. Press **Detail** to view pickup and dropout event details.
6. Press ▼ and ▲ to scroll through the pickup and dropout event details.
7. For unacknowledged alarms, press **Ack** to acknowledge the alarm.
8. Press ▲ to return to the alarm list on the previous screen.
9. For unacknowledged alarms, follow Steps 4 to 7 until all alarms are acknowledged.

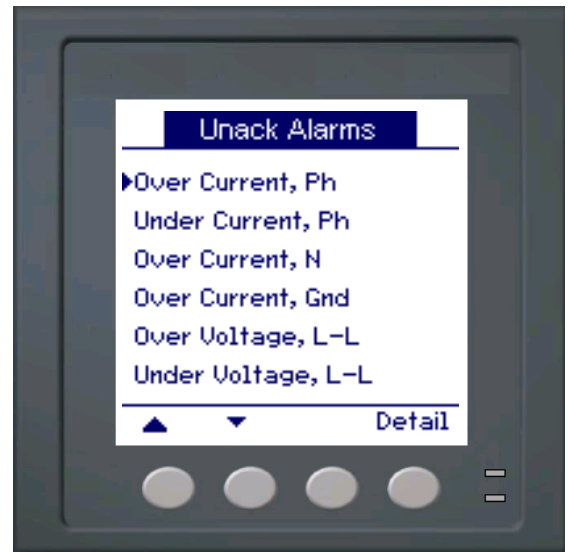

Alarm History	
Meter Reset	
05/03/13 12:00:00 AM	
Event	Unary
Phase	None
Value	0

Chapter 8—Data Logs

This chapter briefly describes the following logs of the power and energy meter:

- Alarm Log
- User-defined data log

Logs are files stored in the non-volatile memory of the power and energy meter and are referred to as “on-board logs”.

Data Logs

The PM5300 series records and stores readings at regularly scheduled intervals in one independent data log. This log will be in disabled state from the factory. You can set up the data log to store the following information.

- Time Interval: 15, 30, 60 minutes
- First-in-first-out (FIFO) or Fill and Hold
- Values logged - up to 2 registers along with data and time of each log entry

The registers list for configuring the data logs

Description	Number of Registers	Data Type	Register Number
Active energy delivered	4	Integer	3204
Active energy received	4	Integer	3208
Reactive energy delivered	4	Integer	3220
Reactive energy received	4	Integer	3224
Apparent energy delivered	4	Integer	3236
Apparent energy received	4	Integer	3240
Status input 1 counter	1	Integer	8915
Status input 2 counter	1	Integer	8919

Memory Allocation for Log Files

Each file in the power and energy meter has a maximum memory size. Memory is not shared between the different logs, so reducing the number of values recorded in one log will not allow more values to be stored in different log. The following table lists the memory allocated to each log.

Log Type	Max. Records Stored	Storage (Bytes)	Power and Energy Meter Model
Alarm Log	100	2,200	All models
Data Log	5760	256k	All models

Alarm Log

By default, the power and energy meter can log the occurrence of any alarm condition. Each time an alarm occurs it is entered into the alarm log. The alarm log in the power and energy meter stores the pickup and dropout points of alarms along with the date and time associated with these alarms. With PowerLogic software, user can view and save the alarm log to disk, and reset the alarm log to clear the data out of the power and energy meter's memory.

Alarm Log Storage

The power and energy meter stores alarm log data in non-volatile memory. The size of the alarm log is fixed at 40 records.

Chapter 9—Measurements and calculations

This section describes how the meter processes measured and calculated data.

Real-time readings

The power and energy meter measures currents and voltages, and reports in real time the RMS (Root Mean Squared) values for all three phases and neutral. The voltage and current inputs are continuously monitored at a sampling rate of 64 points per cycle. This amount of resolution helps enable the meter to provide reliable measurements and calculated electrical values for various commercial, buildings and industrial applications.

Related topics

- To learn how to navigate to the data screens using the front panel, see “Viewing Meter Data” on page 45.

Energy

The power and energy meter calculates and stores accumulated energy values for real, reactive, and apparent energy.

You can view accumulated energy from the display. The energy value units automatically change, based on the quantity of energy accumulated (e.g., from **kWh** to **MWh**, from **MWh** to **GWh**, then from **GWh** to **TWh**, from **TWh** to **PWh**).

Related topics

- To view energy readings from the front panel display, see “Meter data display screens” on page 45.

Min/max values

The meter’s real-time readings are updated once every 50 cycles for 50 Hz systems, or once every 60 cycles for 60 Hz systems. When the readings reach their lowest or highest value, the meter updates and saves these min/max (minimum and maximum) quantities in non-volatile memory.

Power factor

Power factor (PF) is the ratio of active power (P) to apparent power (S), and is a number between zero (0) and one (1). In a purely resistive circuit, PF is equal to 1 (unity PF). Inductive or capacitive loads increase the reactive power (Q) component in the circuit which causes the PF to become less than 1.

Power factor can have a positive or negative sign, depending on the type of load or direction of power flow. See “Power factor sign convention” on page 78.

Power factor min/max convention

The meter uses the following convention for power factor minimums and maximums:

- For negative PF readings, the minimum PF value is the measurement closest to -0 for PF readings between -0 to -1. For positive PF readings, the minimum PF value is the measurement closest to +1 for PF readings between +1 to +0.
- For negative PF readings, the maximum PF value is the measurement closest to -1 for PF readings between -0 to -1. For positive PF readings, the maximum PF value is the measurement closest to +0 for PF readings between +1 to +0.

Power factor minimum and maximum

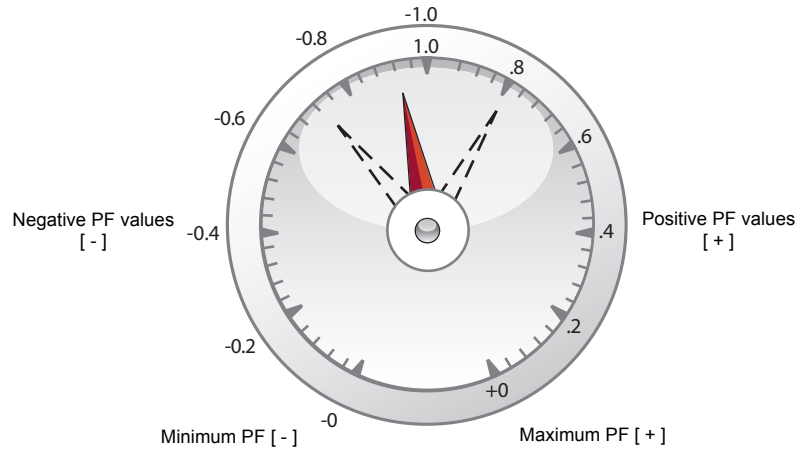

Power factor sign convention

You can set the power factor sign (PF sign) convention by changing the HMI mode to either IEC or IEEE.

Power factor sign convention

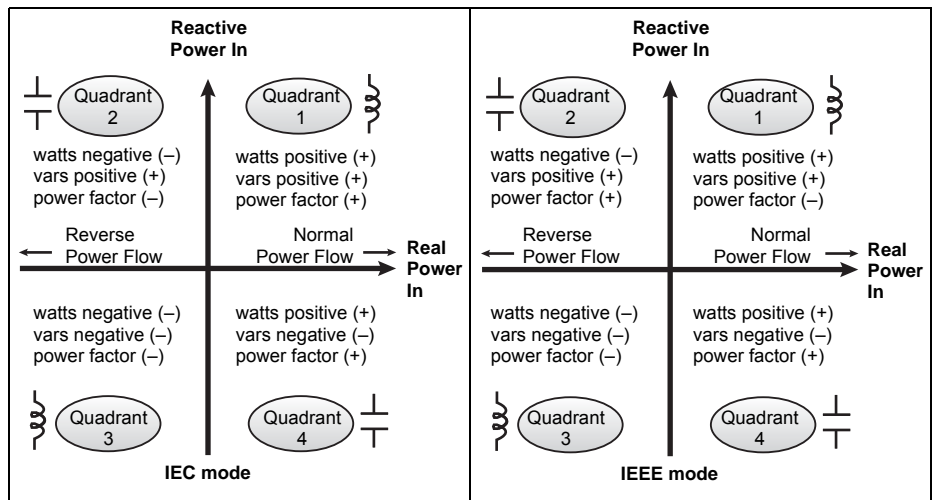

IEC mode

In IEC mode, the PF sign follows the direction of power flow. PF sign is positive (+) for positive (normal) power flow. PF sign is negative (-) for negative (reverse) power flow.

IEEE mode

In IEEE mode, the PF sign is determined by the type of load (inductive or capacitive) contributing to the reactive power component of apparent power. PF sign is positive (+) for capacitive loads (leading power factor). PF sign is negative (-) for inductive loads (lagging power factor).

Related topics

- To change the HMI mode, see “Setting up regional settings” on page 39.
- To learn how the meter calculates power factor, see “Power factor” on page 77.

Demand

Demand is a measure of average consumption (typically power or current) over a fixed programmed time interval.

The meter measures instantaneous consumption and can calculate demand using various methods.

Related topics

- For instructions on configuring demand using the front panel, see “Demand setup” on page 43

Power demand calculation methods

Power demand is calculated by dividing the energy accumulated during a specified period by the length of that period. How the power meter performs this calculation depends on the method and time parameters you select (for example, timed rolling block demand with a 15-minute interval).

To be compatible with electric utility billing practices, the power meter provides the following types of power demand calculations:

- Block interval demand
- Synchronized demand
- Thermal demand

You can configure the power demand calculation method from the front panel or using ION Setup.

Block interval demand

For block interval demand method types, you specify a period of time interval (or block) that the power meter uses for the demand calculation. Select/configure how the power meter handles that interval from one of these different methods:

- **Timed Sliding Block:** Select an interval from 1 to 60 minutes (in 1-minute increments). If the interval is between 1 and 15 minutes, the demand calculation *updates every 15 seconds*. If the interval is between 16 and 60 minutes, the demand calculation *updates every 60 seconds*. The power meter displays the demand value for the last completed interval.
- **Timed Block:** Select an interval from 1 to 60 minutes (in 1-minute increments). The power meter calculates and updates the demand at the end of each interval.
- **Timed Rolling Block:** Select an interval and a subinterval. The subinterval must divide evenly into the interval (for example, three 5-minute subintervals for a 15-minute interval). Demand is *updated at the end of each subinterval*. The power meter displays the demand value for the last completed interval.

The following illustration shows the different ways power demand is calculated using the block interval method. In this example, the interval is set to 15 minutes.

Block interval demand example

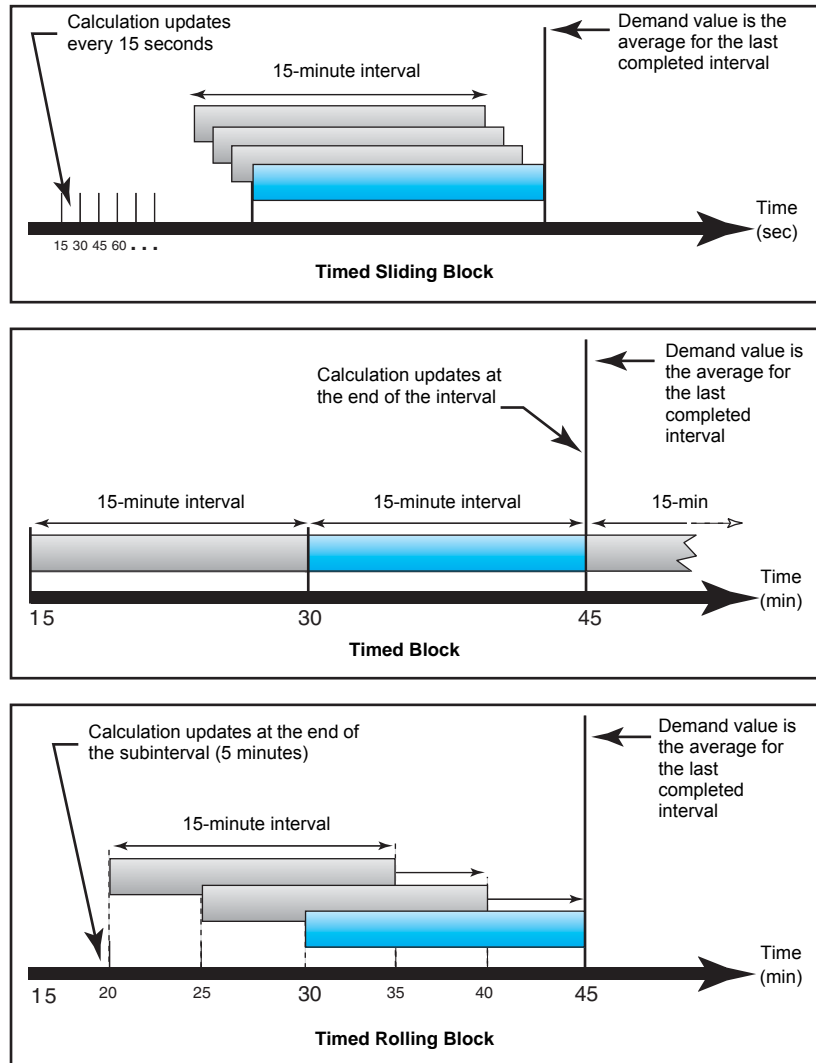

Synchronized demand

You can configure the demand calculations to be synchronized using a command sent over communications or the device's internal real-time clock.

- **Input synchronized demand:** This method allows you to synchronize the demand interval of your meter with an external digital pulse source (such as another power meter's digital output) connected to your meter's digital input. This helps synchronize your meter to the same time interval as the other meter for each demand calculation. When setting up this type of demand, you can choose **Input Sync Block** (input-synchronized block demand) or **Input Sync Roll Blk** (input-synchronized rolling block demand). **Input Sync Roll Blk** requires that you specify a subinterval.
- **Command synchronized demand:** This method allows you to synchronize the demand intervals of multiple meters on a communications network. For example, if a programmable logic controller (PLC) input is monitoring a pulse at the end of a demand interval on a utility revenue meter, you can program the PLC to issue a command to multiple meters whenever the utility meter starts a new demand interval. Each time the command is issued, the demand readings of each meter are calculated for the same interval. When setting up this type of demand, you can

choose **Cmd Sync Block** (command-synchronized block demand) or **Cmd Sync Roll Block** (command-synchronized rolling block demand). **Cmd Sync Roll Blk** requires that you specify a subinterval.

- **Clock synchronized demand:** This method allows you to synchronize the demand interval to the power meter’s internal real-time clock. This helps you synchronize the demand to a particular time, typically on the hour (for example, at 12:00 am). If you select another time of day when the demand intervals are to be synchronized, the time must be specified in minutes from midnight. For example, to synchronize at 8:00 am, select 0800 (in hhmm format). When setting up this type of demand, you can choose **Clock Sync Block** (clock-synchronized block demand) or **Clock Sync Roll Blk** (clock-synchronized rolling block demand). **Clock Sync Roll Blk** requires that you specify a subinterval.

Thermal demand

Thermal demand calculates the demand based on a thermal response, which imitates the function of thermal demand meters. The demand calculation updates at the end of each interval. You can set the demand interval from 1 to 60 minutes (in 1-minute increments).

The following illustration shows the thermal demand calculation. In this example, the interval is set to 15 minutes.

Thermal demand example

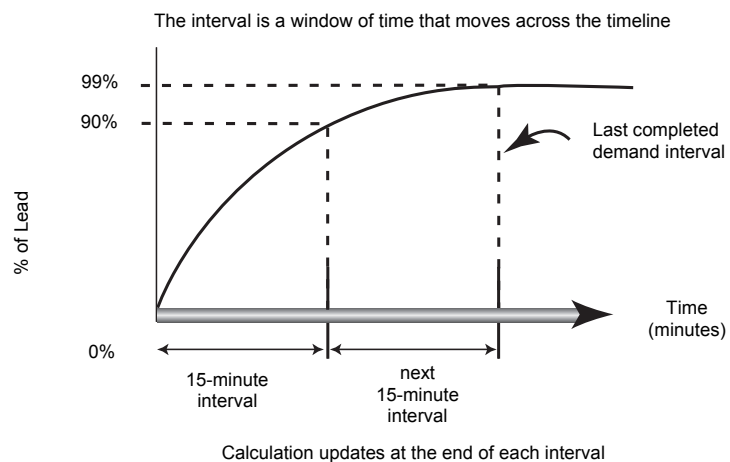

Current demand

The power meter calculates current demand using one of the methods described in “Power demand calculation methods” on page 79. You can set the demand interval from 1 to 60 minutes in 1-minute increments (for example, 15 minutes).

Predicted demand

The power meter calculates predicted demand for the end of the present interval for kW, kVAR, kVA and Amps demand. This prediction takes into account the energy consumption so far within the present (partial) interval and the present rate of consumption.

Predicted demand is updated every second.

The following illustration shows how a change in load can affect predicted demand for the interval. In this example, the interval is set to 15 minutes.

Predicted demand example

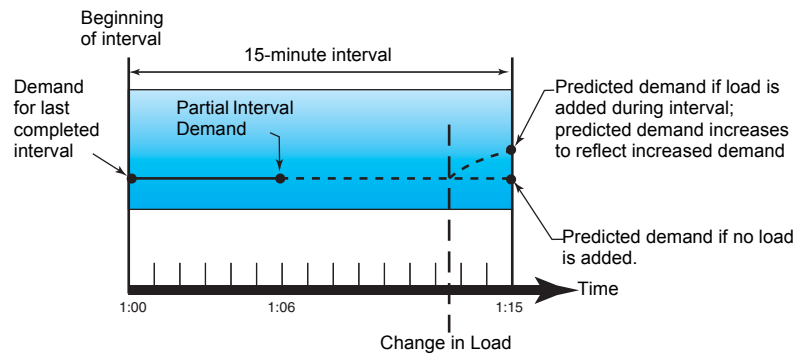

Peak demand

The maximum values for the kWd, kVARD, kVAD power, and amps (or peak demand) is maintained in the meter's non-volatile memory. The peak for each value is the highest average reading since the meter was last reset. The power meter also stores the date and time when the peak demand occurred. In addition to the peak demand, the power meter also stores the coinciding average 3-phase power factor. The average 3-phase power factor is defined as "demand kW/demand kVA" for the peak demand interval.

Related topics

- To reset peak demand values from the power meter display, see "Single resets" on page 100.

Chapter 10—Multi-tariff feature

This section describes how to set up different tariffs for storing energy values in registers that correspond to each of those tariffs. An example of when this feature can be used is when a utility has set up tariff schedules with different rates based on what day or time of day energy is consumed.

The meter supports configuration of up to 4 different tariffs.

Multi-tariff feature example

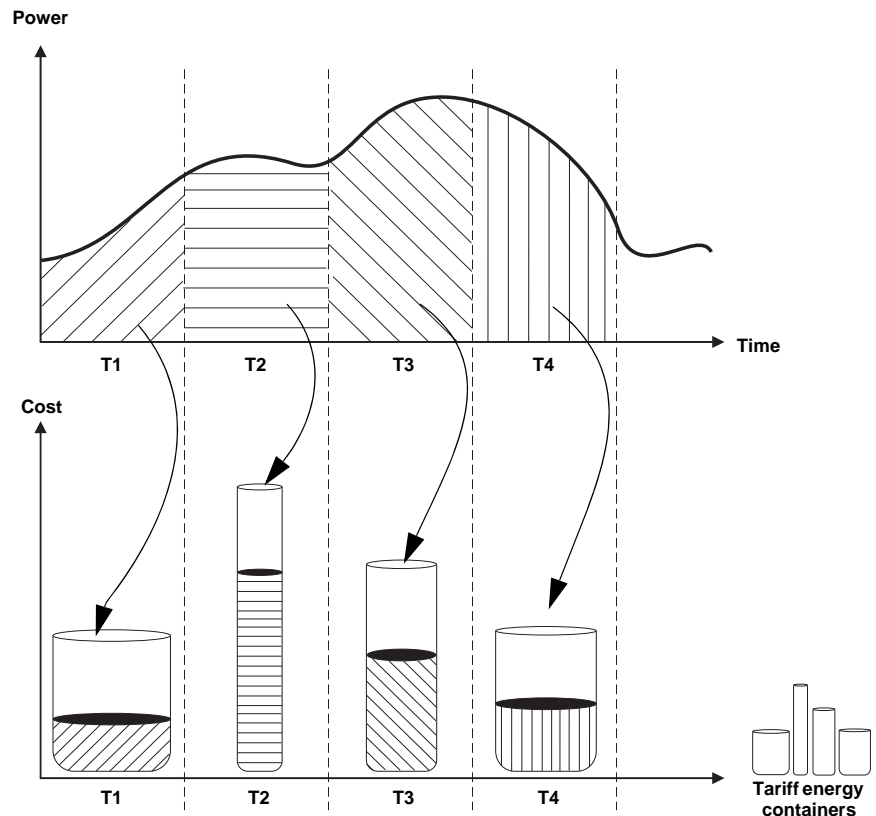

In the above illustration, the area under the power curve equals the energy consumed.

Typically, the utility sets tariff schedules so the cost of energy is higher during high demand or high energy consumption times. How these “tariff energy containers” are configured determines how fast these containers fill, which correlates to increasing energy costs. The price per kWh is lowest at tariff T1 and highest at tariff T2.

Multi-tariff feature overview

The meter supports multiple tariffs to measure and monitor energy usage that can be used in billing or cost applications. There are different tariff modes you can use to determine what tariff is applied and when: Command mode, Time of Day mode, and Input mode.

Command mode overview

You can use this mode to send a Modbus command to the device which sets the active tariff. This tariff is applied to the measured energy until you send another Modbus command that sets a different tariff.

Related topics

- Search PM5300 Modbus register list at www.schneider-electric.com to download the Modbus map.

Time of day mode overview

You can use this mode to create a tariff schedule that specifies where the meter stores energy or input metered data, based on the time of year (month, day), the type of day (every day, weekend, weekday or a specific day of the week), or time of day. The data collected from the different tariffs can then be used in energy audits or similar costing and budget planning purposes.

Time format

Multi-tariff configuration using the front panel uses this date and time format:

Front panel date and time format

Parameter	Values	Description
Month	1 to 12	The calendar month, where 1 = January, 2 = February, 3 = March, 4 = April, 5 = May, 6 = June, 7 = July, 8 = August, 9 = September, 10 = October, 11 = November, 12 = December.
Day	1 to 31	The calendar day of the month.
Time	0000 to 2359	The time in 24-hour clock format, where 0000 = 00:00 (12:00 am) and 2359 = 23:59 (11:59 pm).

NOTE: Use ION Setup if you want to configure **Time of Day** tariff using the 12-hour clock (i.e., 12:00 am to 11:59 pm).

Tariff validity

A valid tariff has certain conditions and limitations:

- Each tariff must cover a unique time period (tariffs cannot overlap) but there can be periods with no tariff.
- Any number of tariffs, from none to the maximum number of tariffs, can be applied.
- Time of day tariffs do not adjust for daylight savings time.
- Time of day tariffs include February 29th in leap years (however, it is not recommended to have February 29th as a start or end date, as that tariff would be invalid for non-leap years).
- Except for leap years, tariff dates are not year-specific; if you wanted to create a tariff that starts on the first Monday in August, you need to enter the date for that year, then manually update the tariff information for the subsequent years.

Tariff creation method

Your device performs validation checks as you enter tariff information; it prompts you to change the information that you have entered or set the tariff to disabled if the tariff configuration is invalid. These checks can include:

- Start and end times must be different (for example, you cannot create a tariff that starts at 02:00 and also ends at 02:00).
- Start time can only be earlier than end time for tariffs that are applied every day. You can create a daily tariff that starts at 06:00 and ends at 02:00, but these times are only valid for the **Everyday** tariff and invalid for the other tariff types.
- Start day must be earlier than end day if the days are in the same month. You cannot create a tariff that starts June 15 and ends June 12.

There are two methods of creating tariffs:

- Time of year tariffs divide the year into multiple sections (usually seasons), where each section has one or more day types. For example, a four tariff configuration using this method could have Summer and Winter seasons that also use different weekend and weekday tariffs.
- Daily tariffs can divide days by day of the week, a weekday, a weekend, or every day, and can specify the time of day. For example, a four tariff configuration could have every day in the year divided into six-hour tariff periods or could have two tariffs for weekends and two tariffs for weekdays.

You can combine these methods if, for example you wanted to create a tariff that applies on Mondays from January 1 to June 30, from 09:00 to 17:00. However, since only one tariff can be applied at any time, you cannot use an everyday or weekday tariff type because you already specified a tariff for the time periods 09:00 to 17:00.

Depending on how you configure the tariffs and the maximum number of tariffs supported by your meter, you may not be able to assign tariffs for the entire year, potentially leaving time gaps that do not have any tariff assigned to them.

Example tariff configurations for a four-tariff system

In these examples, four tariffs are used to cover the entire year (there are no time periods that do not have an associated tariff).

Configuration 1: four tariffs with weekdays and weekends

Tariff	Type	Start date	End date	Start time	End time ¹
1	Weekend	June 21	December 20	00:00	23:59
2	Weekend	December 21	June 20	00:00	23:59
3	Weekday	June 21	December 20	00:00	23:59
4	Weekday	December 21	June 20	00:00	23:59

¹ End time of 23:59 is actually 23:59:59, or just before midnight.

All weekend days fall into one of two different tariffs, depending on the date. All week days fall into one of two different tariffs, depending on the date. This configuration does not use tariffs based on the time of day, or any day types other than weekend or weekday.

Example dates and corresponding tariffs:

- Friday, June 29 = tariff 3
- Sunday, November 18 = tariff 1

Configuration 2: one season for weekends, with off-peak and shoulder hours, two seasons for weekdays, with shoulder hours

Tariff	Type	Start date	End date	Start time	End time
1	Every day	January 1	December 31	23:00	04:59
2	Weekdays	May 1	September 30	05:00	22:59
3	Weekdays	October 1	April 30	05:00	22:59
4	Weekends	January 1	December 31	05:00	22:59

All days have a tariff applied between 23:00 and 04:59, corresponding to off-peak hours. All weekend days have a tariff applied from 05:00 to 22:59, corresponding to shoulder hours. All weekdays fall into one of two seasons (summer or winter), and have two tariffs applied throughout the day. Example dates and corresponding tariffs:

- Wednesday, March 21, 08:00 = tariff 3
- Tuesday, January 10, 21:00 = tariff 3
- Sunday, June 24, 14:00 = tariff 4
- Friday, August 17, 00:00 = tariff 1

Input mode overview

You can use this mode to have the device's digital inputs set which tariff is applied to the energy that is presently being consumed. If a digital input is used for multi-tariff, it cannot be used for an exclusive association (such as Demand Sync or Input Metering), but digital inputs can be shared with a non-exclusive association (such as Alarms). To make a digital input available for setting tariffs, any conflicting associations must be manually removed at the source of the original association.

The number of different tariffs that can be applied is determined by the number of available digital inputs and the total number of tariffs supported by your device. The digital inputs are used as binary counters to identify the appropriate tariff, where off = 0 and on = 1, and most significant bit (MSB) is digital input 2 and least significant bit (LSB) is digital input 1. By this definition, digital input 1 must be associated with the multi-tariff feature in order to set the tariff to **Input** mode.

Digital input requirements for required number of tariffs

Number of tariffs required	Digital inputs required	
	Configuration 1	Configuration 2
1	1 (digital input 1)	1 (digital input 1)
2	1 (digital input 1)	2 (digital input 1 and 2)
3	2 (digital input 1 and 2)	2 (digital input 1 and 2)
4	2 (digital input 1 and 2)	2 (digital input 1 and 2)

Configuration 1: 2 tariff assignment using 2 digital inputs¹

Tariff	Digital input 2	Digital input 1
T1	0	0
T2	0	1

¹ There is no inactive tariff with this configuration.

Configuration 2: 2 tariff assignment using 2 digital inputs

Tariff	Digital input 2	Digital input 1
None ¹	0	0
T1	0	1
T2	1	0

¹ This digital input configuration (00) means there are no active tariffs (all tariffs are disabled)

Configuring tariffs using the front panel

This section explains how to use the front panel to set up tariffs.

Tariff setup menu tree

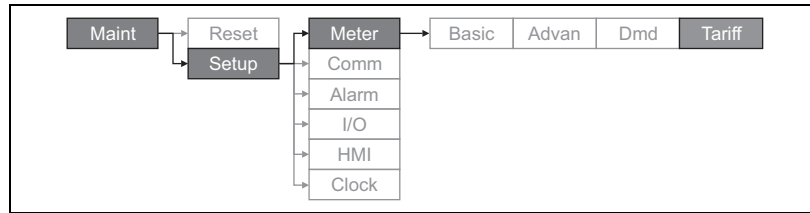

You can change the tariff mode using the front panel.

When the meter is set to command mode for tariffs, the active tariff is controlled by Modbus commands sent from your energy management system or other Modbus master.

Related topics

- Search PM5300 Modbus register list at www.schneider-electric.com to download the Modbus map.

Configuring time of day mode tariffs using the front panel

When the meter is set to time of day for tariffs, the active tariff is determined by the day type, the start and end times, and the start and end dates. The time of day tariff is not a calendar; the meter does not calculate the corresponding day of the week to a specific date, but February 29th is considered a valid date if you are programming the meter during a leap year.

When you enter tariff times using the front panel, be aware that the displayed minute value includes the entire minute. For example, an end time of 01:15 includes the time from 01:15:00 through 01:15:59. To create a tariff period that starts right after this, you must set the next tariff's start time to 01:16. Although it may appear that there is a gap between these tariffs, there is not.

1. Navigate to **Maint > Setup**.
2. Enter the setup password (default is "0"), then press **OK**.
3. Navigate to **Meter > Tariff**.
4. With the cursor pointing to **Mode**, press **Edit**.
5. Press **+** or **-** to change the setting to **Time of Day**, then press **OK**.
6. Move the cursor to point to the tariff (Tariff 1 to Tariff 4) you want to modify, then press **Edit**.

Time of day mode tariff setup

Parameter	Values	Description
Day Type	Everyday, Weekday, Weekend, Monday, Tuesday, Wednesday, Thursday, Friday, Saturday or Sunday	Select which day the tariff is active. Only tariffs that are Everyday can have a tariff that includes midnight (for instance, from 11pm to 2am).
Start Time	0000 to 2359	Set the time when the tariff period starts, using the 24 hour clock format (00:00 to 23:59). The Start Time cannot equal the End Time.
End Time	0000 to 2359	Set the time when the tariff period ends, using the 24 hour clock format (00:00 to 23:59). The End Time cannot equal the Start Time.

Time of day mode tariff setup (continued)

Parameter	Values	Description
Start Month	1 to 12	Set the month that the tariff period starts, where 1 = January, 2 = February, 3 = March, 4 = April, 5 = May, 6 = June, 7 = July, 8 = August, 9 = September, 10 = October, 11 = November, 12 = December.
Start Day	1 to 31	Set the day of the Start Month that the tariff period starts. The Start Day must be earlier than End Day if Start Month equals End Month.
End Month	1 to 12	The month that the tariff period ends, where 1 = January, 2 = February, 3 = March, 4 = April, 5 = May, 6 = June, 7 = July, 8 = August, 9 = September, 10 = October, 11 = November, 12 = December.
End Day	1 to 31	The day of the End Month that the tariff period ends.

7. Modify each parameter as required, then press **OK** to set. Press **▼** or **▲** to move between parameters.
8. Press **▲** to exit, then **Yes** to save your changes. Repeat for the other tariffs as required. The meter checks the configuration and display a message if any tariffs have conflicting settings (i.e., overlapping tariff periods).

Configuring input mode tariffs using the front panel

When you set the tariff type to **Input**, the active tariff is determined by the status of the digital inputs.

Digital inputs are available for tariffs if they are not used, or if they are only associated with alarms (Normal). To make a digital input available, you must manually disconnect the conflicting association before configuring tariffs.

You cannot configure any digital input tariff if digital input 1 is not available for association. Likewise, digital input 2 must be available to select more than two tariffs. The status of the digital inputs is used to calculate the binary value of the active tariff, where off = 0 and on = 1. The calculation of the number of tariffs value can differ, depending on the number of digital inputs that can be selected (i.e., inputs that can be associated with multi-tariff).

To configure input mode tariffs using the front panel:

1. Navigate to **Maint > Setup**.
2. Enter the setup password (default is "0"), then press **OK**.
3. Navigate to **Meter > Tariff**.
4. With the cursor pointing to **Mode**, press **Edit**.
5. Press **+** or **-** to change the setting to **Input**, then press **OK**.

NOTE: If a digital input association error prompt displays, you must exit from the tariff setup screens and remove the digital input association.

6. Navigate to **Tariffs**, then press **Edit**.
7. Press **+** or **-** to change the number of tariffs you want to set up. The maximum number of tariffs that you can apply is determined by the number of available digital inputs, as described in the table, "Digital input requirements for required number of tariffs" on page 86. Press **OK**.
8. Navigate to **Inputs**, then press **Edit**.
9. If applicable, press **+** or **-** to change how many digital inputs you want to use to control which tariff is selected (active). Press **OK**.
10. Press **▲** to exit, then **Yes** to save your changes.

Chapter 11—Power quality

This section describes the meter's power quality features and how to access power quality data.

The meter measures voltage and current harmonics up to the 31st harmonic, and calculates Total Harmonic Distortion (THD) and Total Demand Distortion (TDD and tdd).

Harmonics overview

Harmonics are integer multiples of the fundamental frequency of the power system. Harmonics information is valuable for power quality analysis, determining properly rated transformers, maintenance and troubleshooting.

Harmonics measurements include per-phase magnitudes and angles for the fundamental and higher harmonics relative to the fundamental frequency. The meter's power system setting defines which phases are present and determines how line-to-line or line-to-neutral voltage harmonics and current harmonics are calculated.

Harmonics data provide information to determine how non-linear loads affect the power system. For example, power system harmonics can cause current flow on the neutral conductor, increase heating in electric motors, and eventually damage connected equipment. Power conditioners or harmonic filters can be used to minimize unwanted harmonics.

Total Harmonic Distortion and Total Demand Distortion

Total Harmonic Distortion (THD) is a measure of the total per-phase voltage or current harmonic distortion present in the power system. It provides a general indication of the quality of a waveform. THD is calculated for each phase of both voltage and current.

Total Demand Distortion (TDD) is the per-phase harmonic current distortion against the full load demand of the electrical system. TDD indicates the impact of harmonic distortion in the system. For example, if your system is showing high THD values but a low demand, the impact of harmonic distortion on your system might be insignificant. However at full load, the THD value for the current harmonics is equal to TDD, so this could negatively impact your system.

The meter uses the following series of equations to calculate THD and TDD.

Harmonic content calculations

1. Calculate harmonic content (HC).

$$HC = \sqrt{(H2)^2 + (H3)^2 + (H4)^2 \dots}$$

HC (harmonic content) is equal to the RMS value of all the non-fundamental harmonic components in one phase of the power system.

2. Calculate the harmonic content for current (HCI).

$$HCI = \sqrt{(HI2)^2 + (HI3)^2 + (HI4)^2 \dots}$$

HCI (harmonic content current) is equal to the RMS value of all the non-fundamental current harmonic components ($HI2 \dots HI_n$) in one phase of the power system.

THD and thd calculations

The meter supports two methods of calculating total harmonic distortion: THD and thd.

THD is a quick measure of the total distortion present in a waveform and is the ratio of harmonic content to the fundamental. The meter uses the following equation to calculate THD:

$$\text{THD} = \frac{\text{HC}}{\text{H1}} \times 100$$

Where H1 is equal to the fundamental harmonic.

thd is an alternate method for calculating total harmonic distortion. It uses the RMS value for the total harmonic content rather than the fundamental content. The meter uses the following equation to calculate thd:

$$\text{thd} = \frac{\text{HC}}{\sqrt{(\text{H1})^2 + (\text{HC})^2}} \times 100$$

TDD calculation

TDD (total demand distortion) evaluates the harmonic currents between an end user and a power source. The harmonic values are based on a point of common coupling (PCC), which is a common point where each user receives power from the power source. The meter uses the following equation to calculate TDD:

$$\text{TDD} = (\sqrt{(\text{HCIA})^2 + (\text{HCIB})^2 + (\text{HCIC})^2}) / (\text{ILoad}) \times 100$$

Where ILoad is equal to the maximum demand load on the power system.

Displaying harmonics data

The meter displays the numeric magnitude and angle of the fundamental (first) harmonic.

Viewing harmonics using the front panel

You can view harmonics data using the front panel.

1. Navigate to **Harm**. The Harmonics % screen displays, with the following menu options:

Harmonics % display screens

IEEE mode	IEC mode	Description
V L-L	U	Line-to-line voltage harmonics data
V L-N	V	Line-to-neutral voltage harmonics data
Amps	I	Current harmonics data
TDD	TDD	Total demand distortion

2. Press the voltage or current harmonics you want to view. The fundamental (1st) harmonic's numeric magnitudes and angles for all phases are displayed.
3. Press **3-11**, **13-21**, or **23-31** to view the graphs for the 3rd to 11th, 13th to 21st, or 23rd to 31st harmonics, respectively. For example, to display the 13th to 21st harmonics screen, press **13-21**.

Example: 13th to 21st harmonics for line-to-neutral voltage

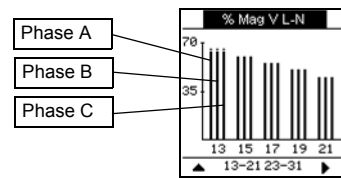

The vertical axis of the harmonics graph indicates the harmonic’s magnitude as a percentage of the fundamental harmonic, and is scaled based on the largest harmonic displayed. At the top of each vertical bar is a marker that shows the maximum value of the harmonic. If the harmonic is greater than the fundamental harmonic, this marker is triangular-shaped to show that the value is out of range.

Viewing TDD

1. Navigate to **Harm > TDD**. The Total demand distortion information displays.

Power Quality display screen

IEEE mode	IEC mode	Description
TDD	TDD	Total demand distortion

NOTE: Your meter’s Modbus map includes registers for harmonics data for integration into your power or energy management system.

2. Press **▲** to return to the main display screens.

Related topics

- See “Front panel display and meter setup” on page 31 for front panel menu navigation details.
- Search PM5300 Modbus register list at www.schneider-electric.com to download the Modbus map.

Viewing THD/thd using the front panel

You can view THD/thd data using the front panel.

1. Navigate to **THD**. On the THD/thd Select screen, press **THD** to display values that use the calculation method based on the fundamental harmonic, or **thd** to display values that use the calculation method based on the RMS value of all harmonics in that phase (including the fundamental).

THD (or thd) display screens

IEEE mode	IEC mode	Description
Amps	I	Total harmonic distortion data for per phase and neutral currents.
V L-L	U	Total harmonic distortion data line-to-line voltage.
V L-N	V	Total harmonic distortion data line-to-neutral voltage.

2. Press the current or voltage THD or thd values you want to view. The total harmonic distortion percentage values are displayed.
3. Press **▲** to return to the main display screens.

NOTE: Your meter’s Modbus map includes registers for total harmonic distortion data for integration into your power or energy management system.

Related topics

- See “Front panel display and meter setup” on page 31 for front panel menu navigation details.
- Search PM5300 Modbus register list at www.schneider-electric.com to download the Modbus map.

Chapter 12—Verifying accuracy

All meters are tested and verified at the factory in accordance with International Electrotechnical Commission (IEC) and American National Standards Institute (ANSI) standards.

Your digital power meter does not require re-calibration. However, in some installations a final accuracy verification of the meters is required, especially if the meters will be used for revenue or billing applications.

Testing overview

The most common method for testing meter accuracy is to apply test voltages and currents from a stable power source and compare the meter's readings with readings from a reference device or energy standard.

Accuracy test requirements

Signal and power source

The meter maintains its accuracy during voltage and current signal source variations but its energy pulsing output needs a stable test signal to help produce accurate test pulses. The meter's energy pulsing mechanism needs approximately 10 seconds to stabilize after every source adjustment.

The meter must be connected to control power in order to conduct accuracy verification testing. Refer to your meter's installation documentation for power supply specifications.

DANGER

HAZARD OF ELECTRIC SHOCK, EXPLOSION OR ARC FLASH

Verify the device's power source meets the specifications for your device's power supply.

Failure to follow these instructions will result in death or serious injury

Control equipment

Control equipment is required for counting and timing the pulse outputs from the alarm / energy pulsing LED or the digital outputs.

- Most standard test benches have an arm equipped with red light sensors to detect LED pulses.
- The reference device or energy standard typically has digital inputs that can detect and count pulses coming from an external source (i.e., the meter's digital output).

NOTE: The optical sensors on the test bench can be disrupted by strong sources of ambient light (such as camera flashes, florescent tubes, sunlight reflections, floodlights, etc). This can cause test errors. Use a hood, if necessary, to block out ambient light.

Environment

The meter should be tested at the same temperature as the testing equipment. The ideal temperature is about 23 °C (73 °F). Make sure the meter is warmed up sufficiently before testing.

A warm-up time of 30 minutes is recommended before beginning energy accuracy verification testing. At the factory, the meters are warmed up to their typical operating temperature before calibration to help ensure that the meters will reach their optimal accuracy at operating temperature.

Most high precision electronic equipment requires a warm up time before it reaches its specified performance levels. Energy meter standards allow the manufacturers to specify meter accuracy derating due to ambient temperature changes and self-heating.

Your meter complies with and meets the requirements of these energy metering standards.

For a list of accuracy standards that your meter complies to, contact your local Schneider Electric representative or download the meter brochure from www.schneider-electric.com.

Reference device or energy standard

To help ensure the accuracy of the test, it is recommended that you use a reference device or reference energy standard with a specified accuracy that is 6 to 10 times more accurate than the meter under test. Before you start testing, the reference device or energy standard should be warmed up as recommended by its manufacturer.

NOTE: Verify the accuracy and precision of all measurement equipment used in accuracy testing (for example, voltmeters, ammeters, power factor meters).

Energy pulsing

You can configure the meter's alarm /energy LED or one of the digital outputs for energy pulsing.

- The meter is equipped with an alarm / energy pulsing LED. When configured for energy pulsing, the LED emits pulses that are then used to determine the accuracy of the meter's energy measurements.

Location of energy pulsing LED

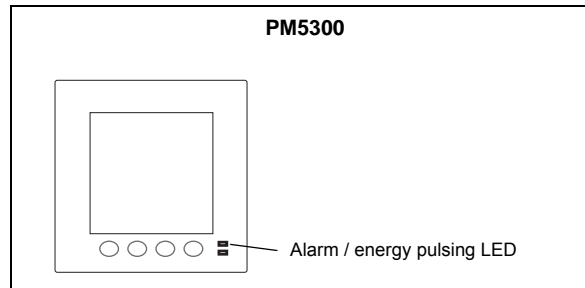

- The meter is equipped with digital outputs. When you configure a digital output for energy pulsing, the meter sends voltage pulses to the digital output port, which are then used to determine the accuracy of the meter's energy measurements.

Verifying accuracy test

The following are guidelines for testing the meter; your meter shop may have specific testing methods.

⚠ DANGER

HAZARD OF ELECTRIC SHOCK, EXPLOSION OR ARC FLASH

- Apply appropriate personal protective equipment (PPE) and follow safe electrical work practices. See NFPA 70E in the USA or applicable local standards.
- Turn off all power supplying this device before working on it.
- Always use a properly rated voltage sensing device to confirm that all power is off.
- Do not exceed the device's ratings for maximum limits.
- Verify the device's power source meets the specifications for your device's power supply.

Failure to follow these instructions will result in death or serious injury.

1. Turn off power to all test equipment. Use a properly rated voltage sensing device to confirm power is off.
2. Connect the test voltage and current source to the reference device or energy standard. Ensure all voltage inputs to the meter under test are connected in parallel and all currents inputs are connected in series.

Connecting the meter to the reference standard and test equipment

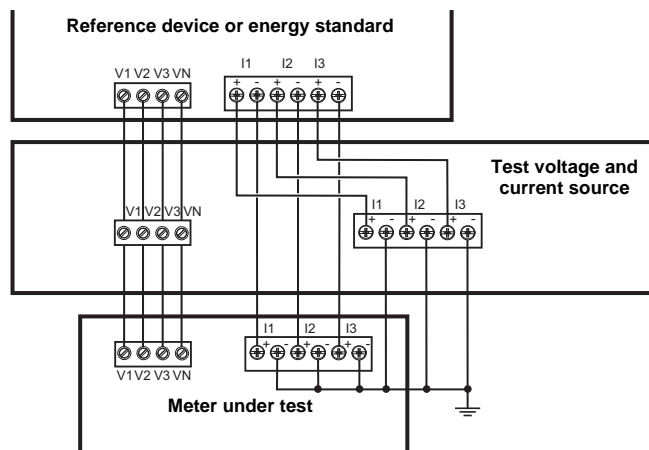

3. Connect the control equipment used for counting the standard output pulses using one of these methods:

Alarm / energy LED	Align the red light sensor on the standard test bench armature over the front panel alarm / energy LED.
Digital output	Connect the meter's digital output to the standard test bench pulse counting connections.

NOTE: When selecting which method to use, be aware that the Alarm / energy LED and digital outputs have different pulse rate limits. See “Energy pulsing considerations” on page 97 for details.

4. Before performing the verification test, let the test equipment power up the meter and apply voltage for at least 30 seconds. This helps stabilize the internal circuitry of the meter.
5. Set the meter's power system to 3PH4W Wye Gnd (3-phase, 4 wire Wye with ground).

6. Depending on the method selected for counting the energy pulses, configure the meter's alarm / energy LED or one of the digital outputs to perform energy pulsing. Set the meter's energy pulse constant so it is in sync with the reference test equipment.
7. Perform accuracy verification on the test points. Run each test point for at least 30 seconds to allow the test bench equipment to read an adequate number of pulses. Allow 10 seconds of dwell time between test points.

Calculating the number of required pulses

The reference test equipment typically requires you to specify the number of pulses required for a test duration of "t" seconds.

Use the following formula to calculate the required number of pulses:

$$\text{Number of pulses} = P_{\text{tot}} \times K \times \frac{t}{3600}$$

Where:

- P_{tot} = total instantaneous power in kilowatts (kW)
- K = the meter's pulse constant setting, in pulses per kWh
- t = test duration, in seconds (typically greater than 30 seconds)

Calculating total power

The test voltage and current source supplies the same test signals to both the energy reference/standard and the meter under test. Total power is calculated as follows:

For a balanced 3-phase Wye system:

$$P_{\text{tot}} = 3 \times V_{\text{LN}} \times I \times \text{PF} \times \frac{1 \text{ kW}}{1000 \text{ W}}$$

NOTE: A balanced 3-phase system assumes the voltage, current and power factor values are the same for all phases.

For a single-phase system:

$$P_{\text{tot}} = V_{\text{LN}} \times I \times \text{PF} \times \frac{1 \text{ kW}}{1000 \text{ W}}$$

Where:

- P_{tot} = total instantaneous power in kilowatts (kW)
- V_{LN} = test point line-to-neutral voltage in volts [V]
- I = test point current in amps [A]
- PF = power factor

The result of the calculation is rounded up to the nearest integer.

Percent error calculation

For every test point:

$$\text{Energy Error} = \frac{EM - ES}{ES} \times 100\%$$

Where:

- EM = energy measured by the meter under test
- ES = energy measured by the reference device or energy standard.

NOTE: If accuracy verification reveals inaccuracies in your meter, they may be caused by typical sources of test errors. If there are no sources of test errors present, please contact your local Schneider Electric representative.

Energy pulsing considerations

The meter’s alarm / energy LED and digital outputs are capable of energy pulsing within the following limits:

Energy pulsing limits

Description	Alarm / energy LED	Digital output
Maximum pulse frequency	50 Hz	25 Hz
Minimum pulse constant	1 pulse per k_h	
Maximum pulse constant	9,999,999 pulses per k_h	

The pulse rate depends on the voltage, current and PF of the input signal source, the number of phases, and the VT and CT ratios.

If P_{tot} is the instantaneous power (in kW) and K is the pulse constant (in pulses per k_h), then the pulse period is:

$$\text{Pulse period (in seconds)} = \frac{3600}{K \times P_{tot}} = \frac{1}{\text{Pulse frequency (Hz)}}$$

VT and CT considerations

The test points are always taken at the secondary side, regardless of whether VTs or CTs are used. P_{tot} is derived from the values of the voltage and current inputs at the secondary side, and takes into account the VT and CT ratios.

If VTs and CTs are used, you must include their primary and secondary ratings in the equation. For example, in a balanced 3-phase Wye system with VTs and CTs:

$$P_{tot} = 3 \times V_{LN} \times \frac{VT \text{ primary}}{VT \text{ secondary}} \times I \times \frac{CT \text{ primary}}{CT \text{ secondary}} \times PF \times \frac{1 \text{ kW}}{1000 \text{ W}}$$

Total power limit for alarm / energy LED

Given the maximum pulse constant (K_{max}) you can enter is 9,999,999 pulses per kWh, and the maximum pulse frequency for the alarm / energy LED is 83 Hz, the maximum total power (Max P_{tot}) the alarm / energy LED’s energy pulsing circuitry can handle is 29.88 Watts:

$$\text{Maximum } P_{tot} = \frac{3600 \times (\text{Maximum pulse frequency})}{K_{max}} = \frac{3600 \times 83}{9,999,999} = 0.02988 \text{ kW}$$

Total power limit for digital output

Given the maximum pulse constant (K_{max}) you can enter is 9,999,999 pulses per kWh, and the maximum pulse frequency for the digital output is 25 Hz, the maximum total power (Max P_{tot}) the digital input’s energy pulsing circuitry can handle is 9 Watts:

$$\text{Maximum P}_{\text{tot}} = \frac{3600 \times (\text{Maximum pulse frequency})}{K_{\text{max}}} = \frac{3600 \times 25}{9,999,999} = 0.009 \text{ kW}$$

Test points

The meter should be tested at full and light loads and at lagging (inductive) power factors to help ensure testing over the entire range of the meter. The test amperage and voltage input rating are labeled on the meter. Refer to the installation sheet or data sheet for your meter's nominal current, voltage and frequency specifications.

Watt-hour test points example

Watt-hour test point	Sample accuracy verification test point
Full load	100% to 200% of the nominal current, 100% of the nominal voltage and nominal frequency at unity power factor or one (1).
Light load	10% of the nominal current, 100% of the nominal voltage and nominal frequency at unity power factor or one (1).
Inductive load (lagging power factor)	100% of the nominal current, 100% of the nominal voltage and nominal frequency at 0.50 lagging power factor (current lagging voltage by 60° phase angle).

Var-hour test points example

Var-hour test point	Sample accuracy verification test point
Full load	100% to 200% of the nominal current, 100% of the nominal voltage and nominal frequency at zero power factor (current lagging voltage by 90° phase angle).
Light load	10% of the nominal current, 100% of the nominal voltage and nominal frequency at zero power factor (current lagging voltage by 90° phase angle).
Inductive load (lagging power factor)	100% of the nominal current, 100% of the nominal voltage and nominal frequency at 0.87 lagging power factor (current lagging voltage by 30° phase angle).

Typical sources of test errors

If excessive errors are observed during accuracy testing, examine your test setup and test procedures to eliminate typical sources of measurement errors:

- Loose connections of voltage or current circuits, often caused by worn-out contacts or terminals. Inspect terminals of test equipment, cables, test harness and the meter under test.
- Meter ambient temperature is significantly different than 23 °C (73 °F).
- Floating (ungrounded) neutral voltage terminal in any configuration with unbalanced phase voltages.
- Inadequate meter control power, resulting in the meter resetting during the test procedure.
- Ambient light interference or sensitivity issues with the optical sensor.
- Unstable power source causing energy pulsing fluctuations.
- Incorrect test setup: not all phases connected to the reference device or the energy standard. All phases connected to the meter under test should also be connected to the reference meter/standard.
- Moisture (condensing humidity), debris or pollution present in the meter under test.

Chapter 13—Meter resets

Reset commands clear the meter’s onboard data logs and related registers. Meter resets are typically performed after you make changes to the meter’s basic setup parameters (such as power system, frequency, or PT/CT settings), to clear invalid or obsolete data in preparation for putting the meter into active service.

The meter reset commands are grouped into two categories: Global Resets and Single Resets.

NOTICE
<p>LOST DATA</p> <p>Record all important data before performing meter resets.</p> <p>Failure to follow these instructions can result in data loss.</p>

Front panel meter reset screens

To access the meter reset screens, navigate to **Maint > Reset**.

Reset menu tree

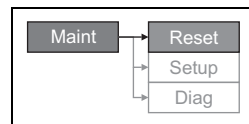

Global resets

Global resets allow you to clear all data of a particular type, such as all energy values or all minimum/maximum values.

Meter Initialization is a special command that clears the meter’s recorded logged data, counters and timers. It is common practice to initialize the meter after its configuration is completed, before adding it to an energy management system.

1. Navigate to **Maint > Reset**.
2. Move the cursor to point to **Global Reset**, then press **Select**.
3. Move the cursor to point to the parameter you want to reset, then press **Reset**.

Global reset options

Parameter	Description
Meter Initialization	Clears all data listed in this table (energy, demand, min/max values, counters, logs, timers, and input metering data).
Energies	Clears all accumulated energy values (kWh, kVARh, kVAh).
Demands	Clears all the demand registers.
Min/Max	Clears all the minimum and maximum registers.
Alarm Counts & Logs	Clears all the alarm counters and alarm logs.
I/O Counts & Timers	Clears all the I/O counters and resets all the timers.

4. Enter the reset password (default is “0000”), then press **OK**.

- Press **Yes** to confirm the reset or **No** to cancel and return to the previous screen.

Single resets

Single resets allow you to clear data only in a specific register or register type.

- Navigate to **Maint > Reset**.
- Move the cursor to point to **Single Reset**, then press **Select**.
- Move the cursor to point to the parameter you want to reset, then press **Reset**. If there are additional options for the parameter, press **Select**, move the cursor to point to the option you want, then press **Reset**.

Single reset options

Parameter	Option	Description
Energy	Accumulated	Clears all accumulated energy values (kWh, kVARh, kVAh).
Demand	Power, Current	Select which demand registers to clear (power demand, current demand or input metering demand).
Alarms	Event Queue	Clears the alarm event queue register.
	History Log	Clears the alarm history log.
Status Inputs	Counters	All Alarm Counts, (various alarm counters) — see the next table
	Timers	All Dig In Timers, Status Input S1, Status Input S2
Digital Outputs	Counters	All Dig In Counters, Status Input S1, Status Input S2
	Timers	All Dig Out Timers, Digital Output D1, Digital Output D2, Relay R1, Relay R2
Active Load Timer	Counters	All Dig Out Counters, Digital Output D1, Digital Output D2, Relay R1, Relay R2
	Timers	All Dig Out Timers, Digital Output D1, Digital Output D2, Relay R1, Relay R2
Multi-Tariff		Clears accumulated values in all tariff register.

- Enter the reset password if prompted (default is “0000”), then press **OK**.
- Press **Yes** to confirm the reset or **No** to cancel and return to the previous screen.

Alarm counter options

Alarm counter	Option	Description
Current	Over Current, Ph	Select which alarm counter register to reset from the current alarm condition counters.
	Under Current, Ph	
	Over Current, N	
	Over Current, Gnd	
Voltage	Over Voltage, L-L	Select which alarm counter register to reset from the voltage alarm condition counters.
	Under Voltage, L-L	
	Over Voltage, L-N	
	Under Voltage, L-N	
	Over Voltage Unbal	
	Over Voltage THD	
	Phase Loss	

Alarm counter options *(continued)*

Alarm counter	Option	Description
Power	Over kW	Select which alarm counter register to reset from the power alarm condition counters.
	Over kVAR	
	Over kVA	
Power Factor	Lead PF, True	Select which alarm counter register to reset from the power factor alarm condition counters.
	Lag PF, True	
	Lead PF, Disp	
	Lag PF, Disp	
Demand	Over kW Dmd, Pres	Select which alarm counter register to reset from the demand alarm condition counters.
	Over kW Dmd, Last	
	Over kW Dmd, Pred	
	Over kVAR Dmd, Pres	
	Over kVAR Dmd, Last	
	Over kVAR Dmd, Pred	
	Over kVA Dmd, Pres	
	Over kVA Dmd, Last	
	Over kVA Dmd, Pred	
Frequency	Over Frequency	Select which alarm counter register to reset from the frequency alarm condition counters.
	Under Frequency	
Unary	Meter Powerup	Select which alarm counter register to reset from the unary alarm condition counters.
	Meter Reset	
	Meter Diagnostic	
	Phase Reversal	
Status Inputs	Digital Alarm S1	Select which alarm counter register to reset from the digital input alarm condition counters.
	Digital Alarm S2	

Chapter 14—Maintenance and Upgrades

Password Recovery

If you lose your password, contact technical support for password recovery assistance:

- Global-PMC-Tech-support@schneider-electric.com
- (00) + 1 (250) 544-3010

NOTE: Be sure to include your power meter's serial number in your e-mail or have it readily available when calling technical support.

Power Meter Memory

The power meter uses its nonvolatile memory to retain all data and metering configuration values. Under the operating temperature range specified for the power meter, this nonvolatile memory has an expected life of at least 45 years.

NOTE: Life expectancy is a function of operating conditions and does not constitute any expressed or implied warranty.

Identifying the Firmware Version, Model, and Serial Number

1. Scroll to [Maint] in the menu list.
2. Press [Maint].
3. Press [Diag].
4. Press [Info].
5. Press ▼ and ▲ to view the model, firmware (OS) version, serial number, and other power meter information.
6. Press ▲ to return to the Maintenance screen.

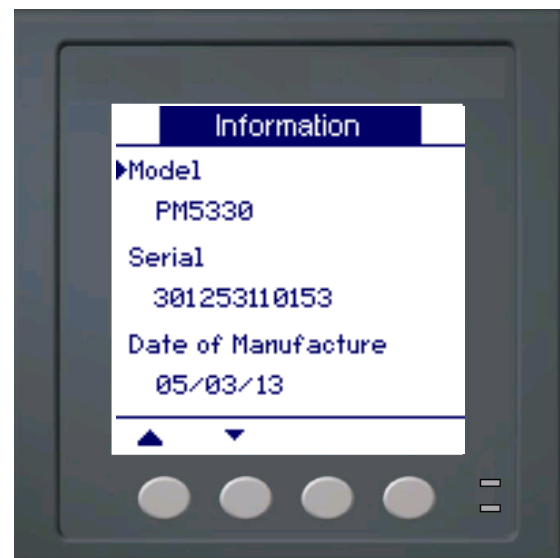

Additional Meter Status Information

Meter

1. Scroll to [Maint] in the menu list.
2. Press [Maint].
3. Press [Diag].
4. Press [Meter].
5. View the power meter status.
6. Press ▲ to return to the Maintenance screen.

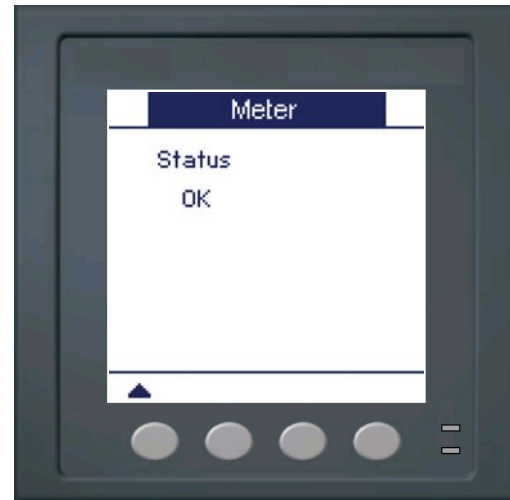

Control Power

1. Scroll to [Maint] in the menu list.
2. Press [Maint].
3. Press [Diag].
4. Press [Cl Pwr].
5. View control Power information.
6. Press ▲ to return to the Maintenance screen.

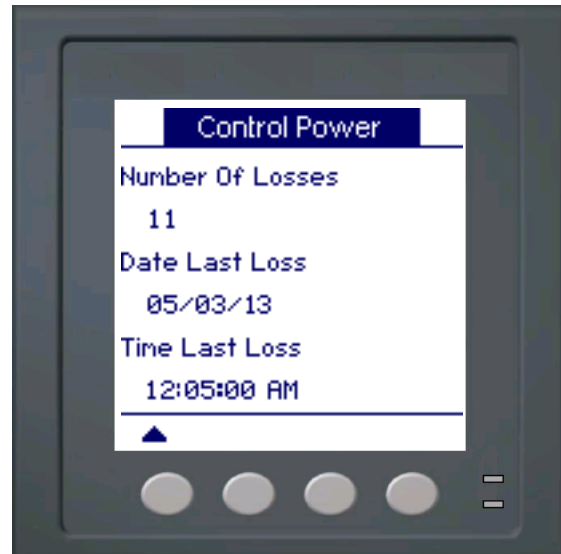

Downloading Firmware

The power meter supports the downloading of new firmware and language files over the communications link. This requires the free DLF3000 software, which is available at www.schneider-electric.com. The DLF3000 offers an extensive Help file with information on operating the software. The most recent firmware and language files are also available on the website. Recommended baud rate for firmware download through communications link is 19200.

Troubleshooting

The information in Table 14–1 on page 106 describes potential problems and their possible causes. It also describes checks you can perform or possible solutions for each. After referring to this table, if you cannot resolve the problem, contact your local Schneider Electric sales representative for assistance.

DANGER

HAZARD OF ELECTRIC SHOCK, EXPLOSION, OR ARC FLASH

- Apply appropriate personal protective equipment (PPE) and follow safe electrical practices. For example, in the United States, see NFPA 70E.
- This equipment must be installed and serviced only by qualified personnel.
- Turn off all power supplying this equipment before working on or inside.
- Always use a properly rated voltage sensing device to confirm that all power is off.
- Carefully inspect the work area for tools and objects that may have been left inside the equipment.
- Use caution while removing or installing panels so that they do not extend into the energized bus; avoid handling the panels, which could cause personal injury.

Failure to follow these instructions will result in death or serious injury.

Heartbeat/Comms LED

The heartbeat/comms LED helps to troubleshoot the power meter. The heartbeat/comms LED works as follows:

- **Normal operation** — the LED flashes at a steady rate during normal operation.
- **Communications** — the LED flash rate changes as the communications port transmits and receives data. If the LED flash rate does not change when data is sent from the host computer, the power meter is not receiving requests from the host computer.
- **Hardware** — if the heartbeat LED remains lit and does not flash ON and OFF, there is a hardware problem. Perform a hard reset of the power meter (turn OFF power to the power meter, then restore power to the power meter). If the heartbeat LED remains lit, contact your local sales representative.
- **Control power and display** — if the heartbeat LED flashes, but the display is blank, the display may not be functioning properly or may have timed out (see “Setting Up the Display” on page 8). If the display is blank and the LED is not lit, verify that control power is connected to the power meter.

Table 14–1: Troubleshooting

Potential Problem	Possible Cause	Possible Solution
The maintenance (wrench) icon is illuminated on the power meter display.	When the maintenance (wrench) icon is illuminated, it indicates an event has occurred which may require attention.	Go to [Maint] > [Diag]. Event messages display to indicate the reason the icon is illuminated. Note these event messages and call the Technical Support or contact your local sales representative for assistance.
The display is blank after applying control power to the power meter.	The power meter may not be receiving the necessary power. The display may have timed out.	Verify that the power meter line and terminals are receiving the necessary power. Verify that the heartbeat LED is blinking. Press a button to see if the display timed out.
The data being displayed is inaccurate or not what you expect.	Incorrect setup values.	Check that the correct values have been entered for power meter setup parameters (CT and VT ratings, Nominal Frequency, and so on). See “Configuring the basic setup parameters” on page 34 for setup instructions.
	Incorrect voltage inputs.	Check power meter voltage input terminals (1, 2, 3, 4) to verify that adequate voltage is present.
	Power meter is wired improperly.	Check that all CTs and VTs are connected correctly (proper polarity is observed) and that they are energized. Check shorting terminals. See the recommended torque in the Wiring section of the installation manual.
Cannot communicate with power meter from a remote personal computer.	Power meter address is incorrect.	Check to see that the power meter is correctly addressed. See “Communications setup” on page 36 for instructions.
	Power meter baud rate is incorrect.	Verify that the baud rate of the power meter matches the baud rate of all other devices on its communications link. See “Communications setup” on page 36 for instructions.
	Communications lines are improperly connected.	Verify the power meter communications connections. Refer to the “Communications” on page 26 section for instructions.
	Communications lines are improperly terminated.	Check to see that a multi-point communications terminator is properly installed.
	Incorrect route statement to power meter.	Check the route statement. Contact Global Technical Support for assistance.
Energy/Alarm LED not working.	May have been disabled by user.	See “Setting up the alarm / energy pulsing LED” on page 42.

The power meter does not contain any user-serviceable parts. If the power meter requires service, contact your local sales representative. Do not open the power meter. Opening the power meter voids the warranty.

Getting Technical Support

Please refer to the *Technical Support Contacts* provided in the power meter shipping carton for a list of support phone numbers by country, or go to www.schneider-electric.com, then navigate to Support area for contact information.

Register List

To download the latest version of the power meter PM5300 Modbus register list, go to www.schneider-electric.com. Type PM5300 in the search field.

Chapter 15—MID Compliance

This section applies only to PM5331/PM5341 (referred to in the section as the meter) and contains descriptions and procedures that supplement the meter installation sheet. The information contained here supports the meter's declaration of compliance with the Measuring Instruments Directive (2004/22/EC).

MID overview

Directive 2004/22/EC is the Measuring Instruments Directive ("MID") from the European Parliament & Council that harmonises many aspects of legal metrology across the EU states.

Scope

Although MID applies to various measuring instruments, the scope of this section is limited only to the MID standards that apply to AC electricity metering equipment:

- **EN 50470-1:2006**
Electricity metering equipment (a.c.) — Part 1: General requirements, tests and test conditions - Metering equipment (class indexes A, B and C)
- **EN 50470-3:2006**
Electricity metering equipment (a.c.) — Part 3: Particular requirements - Static meters for active energy (class indexes A, B and C)

Related topics

- Search the Internet for "Measuring Instruments Directive" or "Directive 2004/22/EC" for more information.
- The CE declaration document is available from the website. Search for ECDPM5000.

MID compliance for the meter

The meter complies to these MID standards and class indexes:

- EN 50470-1:2006 Class C
- EN 50470-3:2006 Class C

The meter achieves MID compliance through application of Annex B (Type Examination) and Annex D (Declaration of Conformity to Type Based on Quality Assurance of the Production Process).

Specifications relevant to MID

The meter meets all specifications listed in "Technical Specifications" on page 15. See that section for mechanical and electrical specifications such as IP rating, rated operating conditions, protective class and environmental conditions.

In addition, the following specifications, function limitations and specific conditions are relevant to MID:

Applicable MID standards and class index	<ul style="list-style-type: none">• EN 50470-1:2006 Class C• EN 50470-3:2006 Class C
Type of measuring equipment	Static watt-hour meter

Intended use		Indoor use only, permanently mounted in residential, commercial or light industrial applications, where levels of vibration and shock are of low significance
Mechanical environment		M1
Electromagnetic (EMC) environment		E2
Active Accuracy Class (kWh)		C(kWh)
System types (for MID-compliant applications)		<ul style="list-style-type: none"> 3-phase 4-wire Wye grounded 3-phase 3-wire Wye ungrounded
Voltage at voltage terminals	3-phase 4-wire Wye grounded	3 x 63.5(110) to 3 x 277(480) V AC
	3-phase 3-wire Wye ungrounded	3 x 110 to 3 x 480 V L-L
Current Rating (I _{min} – I _{ref} (I _{max}))		0.05-5(6) A
Electrical network frequency		50 Hz
Optical pulse output (energy pulsing LED)	Location	Meter front panel
	Frequency	50 Hz maximum
	Pulse constant ¹	10,000 pulses per kWh
	Wavelength	590 to 635 nm
Temperature Range		-25°C to +70°C
IP Rating		IP51
Insulation Protective Class		Class II
Impulse Voltage Rating		6kV
AC Voltage Rating		4kV
Main Cover Sealing Type		Wire and Crimp
Intended Location of the Meter		Indoor

¹ See “MID-protected setup parameters” on page 110 for additional details.

Safety precautions

Installation, wiring, testing and service must be performed in accordance with all local and national electrical codes.

DANGER

HAZARD OF ELECTRIC SHOCK, EXPLOSION OR ARC FLASH

- Apply appropriate personal protective equipment (PPE) and follow safe electrical work practices. See NFPA 70E in the USA or applicable local standards.
- Turn off all power supplying this device before working on it.
- Always use a properly rated voltage sensing device to confirm that all power is off.
- Do not exceed the device's ratings for maximum limits.
- Do not use this device for critical control or protection applications where human or equipment safety relies on the operation of the control circuit.
- Never short the secondary of a voltage transformer (VT).
- Never open circuit a current transformer (CT).
- Always use grounded external CTs for current inputs.

Failure to follow these instructions will result in death or serious injury.

1. Turn off all power supplying this device before working on it.
2. Always use a properly rated voltage sensing device to confirm that all power is off.

Installation and wiring

Refer to the installation sheet that shipped with your meter for meter installation and wiring instructions.

Related topics

- See “Meter mounting” on page 18 and “Meter wiring” on page 19 for additional information.

Installing the terminal covers

The voltage and current terminal covers help prevent tampering with the meter’s voltage and current measurement inputs. The terminal covers enclose the terminals, the conductor fixing screws and a suitable length of the external conductors and their insulation. The terminal covers are secured by tamper-resistant meter seals.

The meter terminal covers must be installed by a qualified installer. The installation of both the voltage and current terminal covers is required to provide tamper evidence for MID installations.

Location of terminal covers

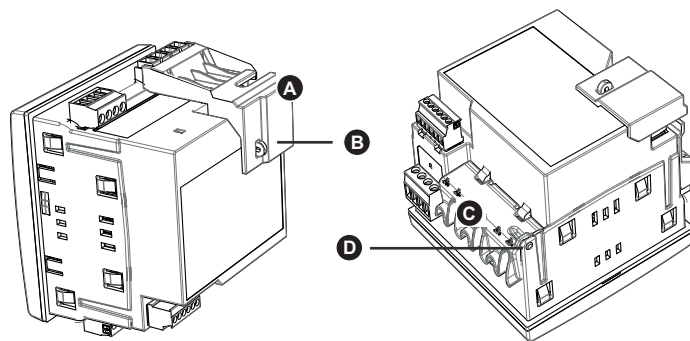

A	Voltage terminal cover
B	Voltage terminal sealing point
C	Current terminal cover
D	Current terminal sealing point

1. Install the voltage terminal cover (A) and apply the seal at the sealing point (B).
2. Install the current terminal cover (C) and apply the seal at the sealing point (D).

PM5331/PM5341 default screen

The meter’s default home screen displays the following information.

Default PM5331/PM5341 display screen

	D	Accumulated real energy (delivered + received)
	B	Active tariff
	C	System frequency
	E	Power system setting
	A	Locked / unlocked icon

Related topics

- See “Front panel display and meter setup” on page 31 for detailed information on front panel menu navigation, LED indicators and display screen notification icons.

Meter firmware version

You can access information about the meter’s OS and RS firmware versions by navigating to **Maint > Diag > Info**.

MID-protected setup parameters

This section describes the setup parameters that are permanently set at the factory and cannot be modified, regardless of the lock or unlock settings.

Front panel LEDs

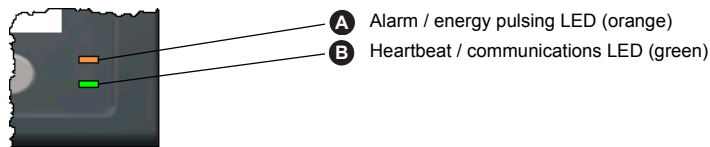

The alarm / energy pulsing LED on the meter is permanently set for energy pulsing and cannot be disabled or used for alarms. All other setup parameters for the energy pulsing LED are also permanently set and cannot be modified.

Lock-protected setup parameters

This section lists the meter’s lock-protected setup parameters for MID compliance. After the meter is locked, these setup parameters are protected and cannot be edited.

The setup parameters can be accessed from the maintenance menu screen. Use the front panel buttons to navigate to the **Maint > Setup** menu.

Lock-protected setup parameters

Setup menu	Setup sub-menu	Lock-protected setup parameter
Meter	Basic	<ul style="list-style-type: none"> • Power System • VT Connect • VT Primary (V) and VT Secondary (V)¹ • CT on Terminal • CT Primary (A) • CT Secondary (A) • Sys Frequency • Phase Rotation
	Advanced	<ul style="list-style-type: none"> • Label
	Tariff	<ul style="list-style-type: none"> • Mode
HMI	User Passwords	<ul style="list-style-type: none"> • Energy Resets
Clock		<ul style="list-style-type: none"> • Date

¹ If using VTs (i.e., if **VT Connect** is set to 3VT or 2VT)

Lock-protected functions

This section lists the meter’s lock-protected functions for MID compliance. After the meter is locked, these functions are disabled.

These functions can be accessed from the maintenance menu screen. Use the front panel buttons to navigate to the **Maint > Reset** menu.

Lock-protected functions

Menu	Sub-menu	Lock-protected function
Resets	Global Resets	<ul style="list-style-type: none"> • Meter Initialization (all) • Energies
	Single Resets	<ul style="list-style-type: none"> • Energy • Multi-Tariff

Setting up the PM5331/PM5341

You must configure all the lock-protected setup parameters before locking the meter. When the meter is locked, those setup parameters cannot be edited.

Basic setup menu

See “Configuring the basic setup parameters” on page 34 to perform basic setup.

For MID compliance, the Power System must be set to one of the following settings:

- 3PH4W Wye Gnd (three-phase 4-wire wye grounded)
- 3PH3W Wye Ungnd (three-phase 3-wire wye ungrounded)

Advanced setup menu

See “Advanced setup” on page 41 to perform advanced setup.

You must use ION Setup to edit the device label.

Clock setup menu

See “Setting the clock” on page 41 to change the meter time using the display.

You can also use ION Setup to set or sync the meter time.

Tariff setup menu

See “Multi-tariff feature overview” on page 83 to configure the energy tariffs.

Passwords setup menu

See “Setting up the screen passwords” on page 39 to change the meter screen passwords.

Initializing the meter

Initializing the meter clears the meter’s logged data, counters and timers. It is common practice to initialize the meter after its configuration is complete, before adding it to an energy management system.

1. After configuring all the meter setup parameters, navigate through the different meter display screens and make sure the displayed data is valid.
2. See “Meter resets” on page 99 for instructions on clearing the meter’s recorded logged data, counters and timers.
3. Select **Meter Initialization** to clear all recorded data.

Locking or unlocking the meter

After you initialize the meter, you must lock it in order to conform to MID standards.

1. Navigate to **Maint > Setup > Meter > Lock**.
2. Press **Edit** to activate or deactivate the lock.
3. Enter your lock password.

NOTE: The default password is 0000. To set up a new password see “Setting up lock password” on page 112.

4. Press **+** and **-** to scroll between **Active** and **Inactive**.
5. Press **OK** to select the option.
6. Select **Yes** to confirm the selected option, and exit the screen.

On activating the lock, a lock icon appears on the upper left corner of the screen.

7. Make sure you record and store the lock password in a secure location. A lost lock password cannot be recovered.

Setting up lock password

To set up a new lock password, perform the below procedure. To change the password, make sure the lock is inactive and perform the below procedure.

NOTE: You cannot change the lock password when the lock is active.

NOTICE

IRRECOVERABLE PASSWORD

Record your meter's lock password information in a secure location.

Failure to follow this instruction can result in a permanently locked meter.

1. Navigate to **Maint > Setup > HMI > Pass**.
2. Press **▼** to scroll to **Revenue Lock** in the **Passwords** screen.
3. Press **Edit** to select a password.
4. Press **+** to increment the active digit through the numerals 0-9.
5. Press **◀** to move to the next digit to the left.
6. Continue until all values are selected, and then press **OK** to set the password.
7. Press **Yes** to save the changes.

Glossary

Terms

accumulated energy—energy accumulates as either delivered to the customer or received from the customer.

active alarm—an alarm that has been set up to trigger the execution of a task or notification when certain conditions are met. An icon in the upper-right corner of the power meter indicates that an alarm is active (!).

ASCII—American Standard Code for Information Interchange

baud rate—specifies how fast data is transmitted across a network port.

block interval demand—demand calculation method for a block of time; includes sliding block, fixed block, or rolling block method.

communications link—a chain of devices connected by a communications cable to a communications port.

current transformer (CT)—current transformer for current inputs.

debounce time—amount of time an input must be consistently on before the transition is accepted as valid.

demand—average value of a quantity, such as power, over a specified interval of time.

device address—used to identify a device on the Modbus communications link; defines where the power meter resides in the power monitoring system.

energy delivered—the utility delivers energy to the facility; energy in.

energy received—the utility receives energy from the facility; the customer provides power to the utility; energy out.

event—the occurrence of an alarm condition, such as *Undervoltage Phase A*, configured in the power meter.

firmware—operating system within the power meter.

fixed block—a demand calculation method using an interval selected from 1 to 60 minutes (in 1-minute increments). The power meter calculates and updates the demand at the end of each interval.

frequency—number of cycles in one second.

GMT—Greenwich Mean Time

k_h— kWh, kVARh or kVAh depending on the energy parameter selected.

lagging current (I)—current is lagging voltage up to 180°.

leading current (I)—current is leading voltage up to 180°.

lagging power factor (PF) —active and reactive power flowing in the same directions.

leading power factor (PF) —active and reactive power flowing in opposite directions.

line-to-line voltages—measurement of the rms line-to-line voltages of the circuit.

line-to-neutral voltages—measurement of the rms line-to-neutral voltages of the circuit.

maximum value—highest value recorded of the instantaneous quantity such as Phase A Current, Phase A Voltage, etc., since the last reset of the minimums and maximums.

minimum value—lowest value recorded of the instantaneous quantity such as Phase A Current, Phase A Voltage, etc., since the last reset of the minimums and maximums.

nominal—typical or average.

parity—refers to binary numbers sent over the communications link. An extra bit is added so that the number of ones in the binary number is either even or odd, depending on your configuration. Used to detect errors in the transmission of data.

- partial interval demand**—equal to energy accumulated thus far in the interval divided by the length of the complete interval.
- peak demand current**—highest demand current measured in amperes since the last reset of demand.
- peak demand real power**—highest demand real power measured since the last reset of demand.
- peak demand**—highest demand measured since the last reset of demand.
- phase currents (rms)**—measurement in amperes of the rms current for each of the three phases of the circuit.
- phase rotation**—refers to the order in which the instantaneous values of the voltages or currents of the system reach their maximum positive values. Two phase rotations are possible: A-B-C or A-C-B.
- potential transformer (PT)**—also known as a voltage transformer (VT).
- power factor (PF)**—power factor is the degree to which voltage and current to a load are out of phase. Total power factor is the difference between the total power your utility delivers and the portion of total power that does useful work. True power factor is the ratio of real power to apparent power using the complete harmonic content of real and apparent power. Calculated by dividing watts by volt amperes. Displacement power factor is the cosine of the angle between the fundamental components of current and voltage, which represents the time lag between fundamental voltage and current.
- real power**—calculation of the real power (3-phase total and per-phase real power calculated) to obtain kilowatts.
- rms**—root mean square. Power meters are true rms sensing devices.
- rolling block**—a selected interval and subinterval that the power meter uses for demand calculation. The subinterval must divide evenly into the interval. Demand is updated at each subinterval, and the power meter displays the demand value for the last completed interval.
- sliding block**—an interval selected from 1 to 60 minutes (in 1-minute increments). If the interval is between 1 and 15 minutes, the demand calculation updates every 15 seconds. If the interval is between 16 and 60 minutes, the demand calculation updates every 60 seconds. The power meter displays the demand value for the last completed interval.
- thermal demand**—demand calculation based on thermal response.
- Total Demand Distortion (TDD)**—indicates the harmonic currents between an end user and a power source.
- Total Harmonic Distortion (THD or thd)**—indicates the degree to which the voltage or current signal is distorted in a circuit.
- total power factor**—*see power factor.*
- true power factor**—*see power factor.*
- unary alarm**—an alarm based on singular events or specific conditions for which setpoints are not appropriate.
- voltage transformer (VT)**—also known as a potential transformer (PT).

Abbreviations

A	—Ampere
Amps	—Amperes
Comms	—Communications
CPT	—Control Power Transformer
CT	—Current Transformer
D In	—Digital Input
D Out	—Digital Output
DMD	—Demand
DO	—Drop Out
F	—Frequency
GMT	—Greenwich Mean Time
Hz	—Hertz
I	—Current
I/O	—Input/Output
I_{max}	—Current maximum demand
k_h	— kWh, kVARh or kVAh depending on the energy parameter selected
kVA	—Kilovolt-Ampere
kVAD	—Kilovolt-Ampere demand
kVAR	—Kilovolt-Ampere reactive
kVARD	—Kilovolt-Ampere reactive demand
kVARH	—Kilovolt-Ampere reactive hour
kW	—Kilowatt
kWD	—Kilowatt demand
kWH	—Kilowatthours
kWH/P	—Kilowatthours per pulse
kW_{max}	—Kilowatt maximum demand
Mag	—Magnitude
Maint	—Maintenance
Min	—Minimum
MnMx	—Minimum and maximum values
MSec	—Milliseconds
MVAh	—Megavolt ampere hour
MVARh	—Megavolt ampere reactive hour
MWh	—Megawatt hour
OS	—Operating System (firmware version)
P	—Real power
P_d	—Real power demand
PF	—Power factor
PM	—Power meter
PQS	—Real, reactive, apparent power
PQSD	—Real, reactive, apparent power demand
Prim	—Primary
PT	—Potential Transformer (also known as VT—Voltage Transformer)
PU	—Pick Up

Pulse—Pulse output mode
Pwr—Power
Q—Reactive power
Qd—Reactive power demand
RS—Firmware reset system version
S—Apparent power
SN—Power meter serial number
Sd—Apparent power demand
Sec—Secondary
Sub-I—Subinterval
TDD—Total Demand Distortion
THD—Total Harmonic Distortion
U—Voltage line to line
V—Volts
VT—Voltage Transformer (also known as PT—Potential Transformer)
VAR—Volt ampere reactive
Vmax—Maximum voltage
Vmin—Minimum voltage

A

advanced setup 41
 alarm
 icon 66
 LED 66
 alarm LED 63
 alarm Log 76
 alarms 63
 digital 65
 setup 70
 icon 63
 LED 63
 list of standard over/under 64
 priorities 66
 setup 66
 digital 70
 standard over/under 67
 unary 69
 standard over/under 63
 setup 67
 unary 66
 setup 69
 viewing activity 72
 viewing history 72

B

block interval demand method 79

C

clock synchronized demand 81

D

data Logs 75
 demand
 current 81
 predicted 81
 thermal 81
 demand current calculation 81
 demand power
 calculation 79
 demand power calculation methods 81
 demand readings
 demand current 81
 demand power calculation methods 79
 peak demand 82
 predicted demand 81
 digital alarms
 setup 70
 digital inputs
 receiving a synch pulse 80
 digital output setup 52

E

electrical characteristics 15
 energy readings 77
 environmental characteristics 16

F

firmware 9
 functions and characteristics 13

I

icon
 alarm 63, 66
 input synchronized demand 80
 inputs
 accepting pulse from another meter 80

L

LED 66
 alarm 63
 comms 105
 heartbeat 105

M

mechanical characteristics 16
 menu tree 33
 metered values
 energy readings 77
 min/max values 77
 mounting the meter 18
 multi-tariff setup 44

N

notification icons 32

P

password
 recovery 103
 peak demand calculation 82
 Power factor 77
 power meter
 accessories 9
 box contents 9
 firmware 9
 hardware 9
 predicted demand calculation 81

R

relay output setup 57
 resets
 of peak demand values 82

S

setup
 alarms 72
 standard over/under alarms
 setup 66
 status input setup 50
 synchronized demand
 clock 81
 input 80
 synchronizing
 demand interval to internal clock 81

T

technical support 106
 thermal demand 81
 thermal demand method 81
 troubleshooting 105

U

unary alarms

setup 69

V

viewing TDD 91
 viewing THD 91

W

wiring
 troubleshooting 106
 wiring diagrams 22

Schneider Electric
35, rue Joseph Monier
CS 30323
F - 92506 Rueil Malmaison Cedex
www.schneider-electric.com

Contact your local Schneider Electric sales
representative for assistance or go to
www.schneider-electric.com

PowerLogic and Schneider Electric are trademarks or registered trademarks of Schneider Electric in France, the USA and other countries.

- This product must be installed, connected and used in compliance with prevailing standards and/or installation regulations.
- If this product is used in a manner not specified by the manufacturer, the protection provided by the product may be impaired.
- The safety of any system incorporating this product is the responsibility of the assembler/installer of the system.

As standards, specifications and designs change from time to time, always ask for confirmation of the information given in this publication.